

THE

DUPLICATE

cherokee **CRUISER** and **FLITE LINER**

PILOT'S OPERATING MANUAL



BY



This manual is incomplete without an APPROPRIATE FAA APPROVED AIRPLANE
FLIGHT MANUAL and an APPROPRIATE WEIGHT AND BALANCE REPORT.

DUPLICATE

WARNING

EXTREME CARE MUST BE EXERCISED TO LIMIT THE USE OF THIS MANUAL TO APPLICABLE AIRCRAFT. THIS MANUAL REVISED AS INDICATED BELOW OR SUBSEQUENTLY REVISED IS VALID FOR USE WITH THE AIRPLANE IDENTIFIED BELOW WHEN APPROVED BY PIPER AIRCRAFT CORPORATION. SUBSEQUENT REVISIONS SUPPLIED BY PIPER AIRCRAFT CORPORATION MUST BE PROPERLY INSERTED.

MODEL PA-28-140

28-7525250

AIRCRAFT SERIAL NO. _____ REGISTRATION NO. _____

PILOT'S OPERATING MANUAL, PART NUMBER 761 555 REVISION 16

PIPER AIRCRAFT CORPORATION
APPROVAL SIGNATURE AND STAMP

Steve J. Cox



Assurance that the airplane is in an airworthy condition is the responsibility of the owner. The pilot in command is responsible for determining that the airplane is safe for flight. The pilot is also responsible for remaining within the operating limitations outlined by the Airplane Flight Manual, instrument markings, and placards.

This Pilot's Operating Manual is not designed as a substitute for adequate and competent flight instruction, knowledge of the current airworthiness directives, applicable federal air regulations, or advisory circulars. It is not intended to be a guide for basic flight instruction or a training manual for transition from single to multi-engine flying.

If an inconsistency of information exists between the Pilot's Operating Manual and the Airplane Flight Manual approved by the FAA, the Airplane Flight Manual shall be the authority.

A complete or partial replacement of this manual, Part No. 761 555, may be obtained only from Piper Customer Services.

Published by
PUBLICATIONS DEPARTMENT
Piper Aircraft Corporation
761 555
Issued: July 1973

APPLICABILITY

This manual is applicable to Piper Model PA-28-140 aircraft having serial numbers 28-7425001 through 28-7625275. Contact Piper Customer Services for specific information on the application of this manual.

REVISIONS

The information compiled in the Pilot's Operating Manual will be kept current by revisions distributed to the airplane owners.

Revision material will consist of information necessary to update the text of the present manual and/or to add information to cover added airplane equipment.

I. Revisions

Revisions will be distributed whenever necessary as complete page replacements or additions and shall be inserted into the manual in accordance with the instructions given below:

1. Revision pages will replace only pages with the same page number.
2. Insert all additional pages in proper numerical order within each section.
3. Page numbers followed by a small letter shall be inserted in direct sequence with the same common numbered page.

II. Identification of Revised Material

Revised text and illustrations shall be indicated by a black vertical line along the left hand margin of the page, opposite revised, added or deleted material. A line opposite the page number or section title and printing date, will indicate that the text or illustration was unchanged but material was relocated to a different page or that an entire page was added.

Black lines will indicate only current revisions with changes and additions to or deletions of existing text and illustrations. Changes in capitalization, spelling, punctuation or the physical location of material on a page will not be identified by symbols.

III. Original Pages Issued

The original pages issued for this manual prior to revision are given below:

1-1 through 1-4, 2-1 through 2-18, 3-1 through 3-18, 4-1 through 4-6, 5-1 through 5-32, 7-1 through 7-11, 8-1 through 8-2, 9-1 through 9-11, 10-1 through 10-15.

PILOT'S OPERATING MANUAL LOG OF REVISIONS

Current Revisions to the PA-28-140 Cherokee Cruiser Pilot's Operating Manual, 761 555, issued July 6, 1973.

Revision	Revised Pages	Description	Date
Rev. 1 - 761 555 (PR731022)	1-1	Changed Instructional Power Cruise Speed from 50% to 60%.	Oct. 22, 1973
	W/B	Added Rev. 1 to Report: VB-546.	
	9-4	Added "Best Economy Mixture".	
	9-5	Revised type size.	
	9-6	Removed NOTE.	
Rev. 2 - 761 555 (PR740529)	9-7	Removed NOTE.	May 29, 1974
	ii	Added PAC Approval Form.	
	iii	Added Applicability and Item III. Original Pages Issued.	
	A F/M W/B	Added Rev. 1 to Report: VB-557. Added Rev. 2 to Report: VB-546. (NOTE: AIRCRAFT DELIVERED WITH MANUALS PRIOR TO THIS REVISION DO NOT REQUIRE THIS REVISION.)	
Rev. 3 - 761 555 (PR740613)	Title	Added Flite Liner.	June 13, 1974
	2-1	Added reference to Flite Liner to The Airplane; relocate info to page 2-2.	
	2-2	Added info from page 2-1.	
	2-8	Added annunciator panel info and foot - note; relocated info to page 2-11.	
	2-9	Revised Alternator and Starter Schematic.	
	2-9a	Added page (Alternator and Starter Schematic).	
	2-10	Relocated page.	
	2-11	Relocated page; added info from page 2-8; added annunciator panel to Vacuum System and Instrument Panel; added footnote.	
	2-12	Relocated page; added annunciator panel.	
	2-12a	Added page.	
	A F/M	Added Rev. 2 to Report: VB-557.	
	4-6	Revised Alternator Failure, item 3.	
	W/B	Added Rev. 3 to Report: VB-546.	
	7-i	Added Airspeed Data and revised page nos.	
	7-4	Added annunciator panel and footnote.	
7-5	Revised Stall info; deleted stall table; added Cruising info from page 7-6; revised Cruising info; revised stall info.		
7-6	Relocate Cruising to page 7-5; added Approach-and Landing info from page 7-7.		

PILOT'S OPERATING MANUAL LOG OF REVISIONS (cont)

Revision	Revised Pages	Description	Date
Rev. 3 (cont)	7-7	Added Airspeed Data; relocated Approach and Landing info to page 7-6.	
	8-1	Revised item 6. (added annunciator); added footnote; relocated info from item 8. to page 8-2.	
	8-2	Added info from page 8-1.	
	9-i	Revised chart nomenclature.	
	9-2	Revised Takeoff chart.	
	9-3	Revised Climb chart.	
	9-4	Revised Power chart.	
	9-5	Revised Cruise chart.	
	9-6	Revised Range chart (36 gal).	
	9-7	Revised Range chart (50 gal).	
	9-8	Revised Glide chart.	
	9-9	Revised Stall chart (weight).	
9-10	Revised Stall chart (angle of bank).		
9-11	Revised Landing chart.		
Rev. 4 - 761 555 (PR741101)	1-2	Revised footnote.	Nov. 1, 1974
	A F/M	Added Rev. 3 to Report: VB-557.	
	W/B	Added Rev. 4 to Report: VB-546.	
	7-4	Added new item 9. and revised existing item nos. under Takeoff.	
8-2	Added item 11.		
Rev. 5 - 761 555 (PR750121)	2-16	Revised Stall Warning description.	Jan. 21, 1975
	W/B	Added Rev. 5 to Report: VB-546.	
	7-10	Revised Operating Instructions for Emergency Locator Transmitter; relocated material to page 7-11.	
7-11	Added material relocated from page 7-10.		
Rev. 6 - 761 555 (PR750516)	1-2	Revised Empty Weight and Useful Load.	May 16, 1975
	W/B	Added Rev. 6 to Report: VB-546.	
	8-1	Relocated item 8. (fuel tip) to page 8-2.	
8-2	Added and revised item 8. (fuel tip).		
Rev. 7 - 761 555 (PR750718)	2-1	Deleted info (AIRFRAME).	July 18, 1975
	2-10	Added callout.	
	2-12	Added Engine Hour Meter; revised callouts.	
	W/B	Added Rev. 7 to Report: VB-546.	

PILOT'S OPERATING MANUAL LOG OF REVISIONS (cont)

Revision	Revised Pages	Description	Date
Rev. 8 - 761 555 (PR751127)	A F/M W/B 7-11 8-2	Added Rev. 4 to Report: VB-557. Added Rev. 8 to Report: VB-546. Revised ELT info. Revised item 8.	Nov. 27, 1975
Rev. 9 - 761 555 (PR760419)	1-2 A F/M 7-4 7-5 7-6 8-2 10-i 10-8 10-9 10-10 10-11 10-12 10-13 10-14	Revised Fuel Specifications. Added Rev. 5 to Report: VB-557. Added Note. Revised Cruising Info. Revised Approach and Landing item 2. Added items 12, 13, 14. Revised page nos. for Filling Fuel Tanks, Draining Fuel Valves and Lines, Facts You Should Know, and Required Service and Inspection Periods. Revised Fuel Requirements; relocated Filling Fuel Tanks to page 10-9. Added Fuel Grade Comparison Chart and info from page 10-8; relocated Draining Fuel Valves and Lines to page 10-10. Added info from page 10-9 and relocated Facts You Should Know to page 10-11. Added info from page 10-10 and relocated info to page 10-12. Added info from page 10-11 and relocated info to page 10-13. Added info from page 10-12. Revised Special Instruction No. 7.	April 19, 1976
Rev. 10 - 761 555 (PR760719)	W/B 7-10 7-11	Added Rev. 9 to Report: VB-546. Added info from page 7-11. Deleted info about Emergency Locator Transmitter. Moved info to page 7-10; revised pilot's remote switch description.	July 19, 1976
Rev. 11 - 761 555 (PR770603)	7-2 7-11	Revised Starting Engines When Hot. Revised ELT Note.	June 3, 1977
Rev. 12 - 761 555 (PR770930)	iii A F/M W/B	Added Applicable Serial Numbers. Added Rev. 6 to Report: VB-557. Added Rev. 10 to Report: VB-546. (NOTE: AIRCRAFT DELIVERED WITH MANUALS PRIOR TO THIS REVISION DO NOT REQUIRE THIS REVISION.)	Sept. 30, 1977

PILOT'S OPERATING MANUAL LOG OF REVISIONS (cont)

Revision	Revised Pages	Description	Date
Rev. 13 - 761 555 (PR790416)	2-8 2-14 W/B 7-10 10-10 10-11	Added Warning. Added Caution. Added Rev. 11 to Report: VB-546. Revised ELT info. Added Caution; relocated info. to pg. 10-11. Added info. from pg. 10-10.	April 16, 1979
Rev. 14 - 761 555 (PR800522)	2-8 W/B	Revised Warning. Added Rev.12 to Report: VB-546.	May 22, 1980
Rev. 15 - 761 555 (PR840713)	1-i 1-2 1-3 2-6 A F/M W/B 7-1 7-4, 8-1 9-i 10-8 10-11 10-12 10-13	Revised General Specifications. Relocated Dimensions to pg. 1-3: revised fuel and Oil specification. Added Dimensions from pg. 1-2. Revised fuel info. Added Rev. 7 to Report: VB-557. Added Rev. 13 to Report: VB-546. Revised Preflight. Added ending serial number effectivity. Added Warning. Revised Fuel Requirements. Revised Handling and Servicing (Facts You Should Know). Revised Preventive Maintenance. Deleted Preventive Maintenance info.; revised Required Service and Inspection Periods.	July 13, 1984
Rev. 16 - 761 555 (PR900316)	iv-c 10-8 10-8a 10-8b 10-9 10-11 10-13	Added Rev. 16 to 761 555 Log of Revisions. Revised Oil Requirements. Moved Fuel System to page 10-8a. Added page. Revised and moved Fuel System from page 10-8. Added page. Revised Fuel Grade Comparison Chart. Revised Handling and Servicing (Facts You Should Know). Revised Required Service and Inspection Periods.	March 16, 1990

TABLE OF CONTENTS

GENERAL SPECIFICATIONS

DESCRIPTION - AIRPLANE AND SYSTEMS

AIRPLANE FLIGHT MANUAL F.A.A. APPROVED

EMERGENCY PROCEDURES F.A.A. APPROVED

EMERGENCY PROCEDURES

WEIGHT AND BALANCE

LOADING INSTRUCTIONS

OPERATING INSTRUCTIONS

OPERATING TIPS

PERFORMANCE CHARTS

HANDLING AND SERVICING

GENERAL SPECIFICATIONS

Performance	1-1
Weights	1-2
Power Plant	1-2
Fuel	1-2
Oil	1-2
Baggage	1-2
Dimensions	1-3
Landing Gear	1-3

BLANK PAGE

BLANK PAGE

GENERAL SPECIFICATIONS

PERFORMANCE

Published figures are for standard airplanes flown at gross weight under standard conditions at sea level, unless otherwise stated. Performance for a specific airplane may vary from published figures depending upon the equipment installed, the condition of engine, airplane and equipment, atmospheric conditions and piloting technique. Each performance figure below is subject to the same conditions as on the corresponding performance chart from which it is taken in the Performance Charts Section.

Takeoff Ground Run, flaps up, sea level (ft)	800
Takeoff Distance Over 50-ft Obstacle, flaps up, sea level (ft)	1700
Best Rate of Climb Speed (mph)	89
Rate of Climb (ft per min)	631
Best Angle of Climb Speed, sea level (mph)	78
Max Speed, sea level (mph)	142*
Max Speed, Optimum Alt, 7800 ft, 75% power (TAS) (mph)	135*
Service Ceiling (ft)	10,950
Absolute Ceiling (ft)	13,000
Cruise Speed at best power mixture, optimum altitude (TAS) (mph)	
65% power, 10,250 ft	127
55% power, 11,900 ft	114
Range at best power mixture optimum altitude (mi)**	
75% power, 7,800 ft	705
65% power, 10,250 ft	765
55% power, 11,900 ft	855
Cruise Speed at best economy mixture, optimum altitude (mph)	
75% power, 7,000 ft	126
65% power, 10,000 ft	120
55% power, 12,000 ft	114
Range at best economy mixture, optimum altitude (mi)**	
75% power, 7,000 ft	720
65% power, 10,000 ft	795
55% power, 12,000 ft	880
Cruising Speed, sea level, 75% power (mph)	124
Instructional power cruise speed, sea level, 60% power (mph)	110
Cruising range, sea level, 75% power (mi)	475
	(675***)
Instructional power cruising range, sea level, 60% power, (mi)	540
	(760***)

*All speeds stated are with optional wheel fairings installed. Subtract 3 mph if wheel fairings are not installed.

**Ranges based on 48 gal usable fuel, no reserve.

***Ranges adjusted to reflect the use of best economy speeds with best economy fuel flows, and 48 gallons usable.

CHEROKEE CRUISER

Fuel Consumption, 75% power (gal per hr)	8.4
Fuel Consumption, 50% power (gal per hr)	5.6
Stalling Speed, flaps down (mph)	55
Landing Roll, flaps down (ft)	535

WEIGHTS

Gross Weight (lbs)	2150
Standard Empty Weight (lbs)	1275
Maximum Useful Load (lbs)	875

POWER PLANT

Engine - Lycoming	O-320-E3D
Rated Horsepower and Speed (rpm)	150 at 2700
Bore (inches)	5.125
Stroke (inches)	3.875
Displacement (cubic inches)	319.8
Compression Ratio	7:1
Dry Weight (pounds)	276
Oil Sump Capacity (quarts)	8
Propeller (Sensenich)	M74DM

FUEL

AVGAS ONLY

Fuel Capacity (U.S. gal) Standard	36
Fuel Capacity (U.S. gal) Reserve	50
Fuel, Aviation Grade	
Minimum Octane	80/87
Specified Octane	80/87
Alternate Fuels	Refer to Fuel Requirements, Section 10 - Page 10-8

OIL

Oil Capacity (quarts)	8
-----------------------	---

BAGGAGE

Maximum Baggage (lbs)	200*
Baggage Space (cubic ft)	22

* See Weight and Balance for limitations when family seats and safety family seats are installed or baggage area modified in accordance with Piper Drawing 66671.

DIMENSIONS

Wing Span (ft)	30
Wing Area (sq ft)	160
Wing Loading (lbs per sq ft)	13.4
Length (ft)	23.3
Height (ft)	7.3
Power Loading (lbs per hp)	14.3

LANDING GEAR

Wheel Base (ft)	6.2
Wheel Tread (ft)	10.0
Tire Pressure (lbs)	Nose 24
	Main 24
Tire Size	Nose (4 ply rating) 6.00 x 6
	Main (4 ply rating) 6.00 x 6

CHEROKEE CRUISER

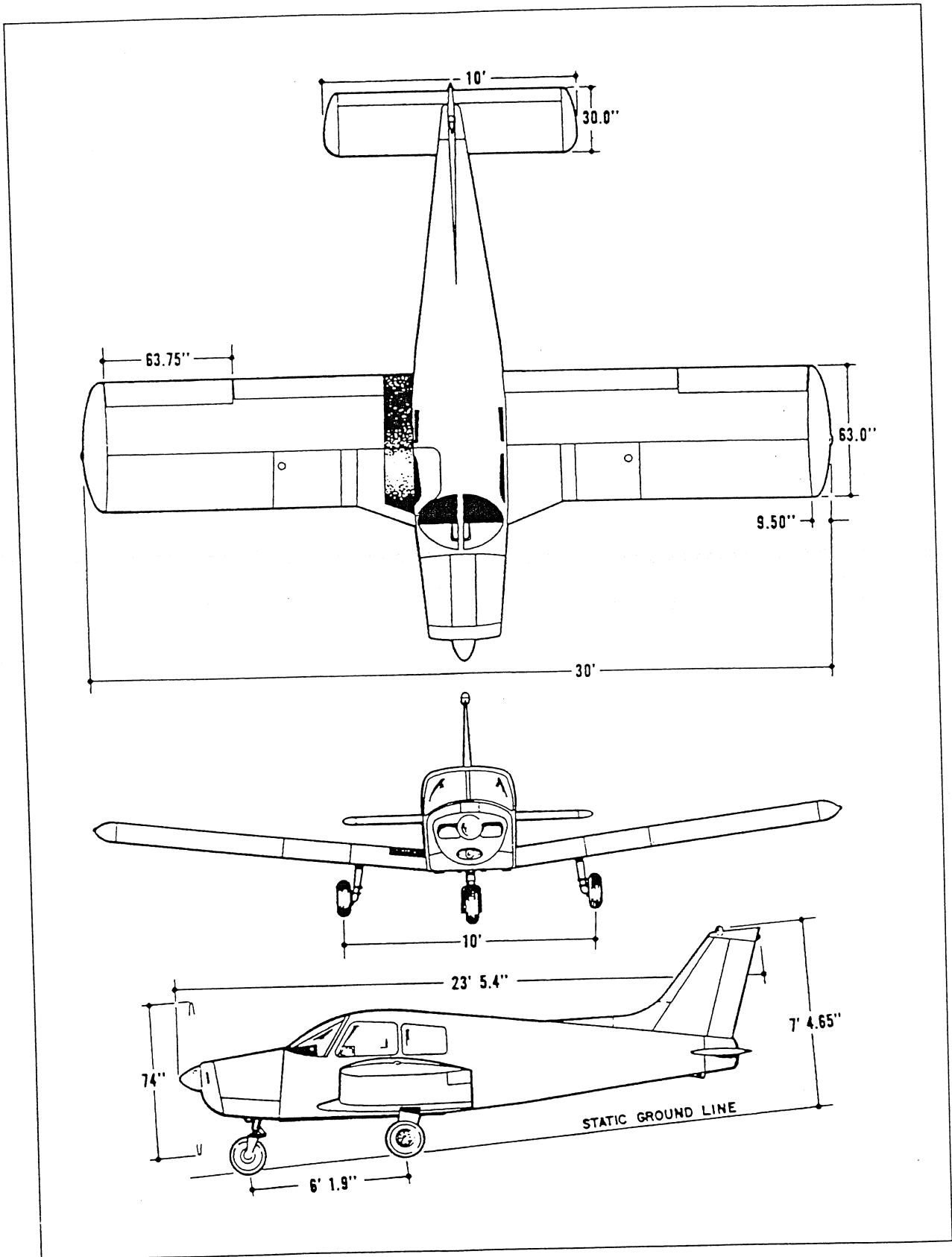

GENERAL SPECIFICATIONS
ISSUED: JULY 6, 1973

DESCRIPTION

AIRPLANE AND SYSTEMS

The Airplane	2-1
Airframe	2-1
Engine and Propeller	2-1
Landing Gear	2-2
Flight Controls	2-5
Fuel System	2-5
Electrical System	2-8
Vacuum System	2-11
Instrument Panel	2-11
Pitot-Static System	2-14
Heating and Ventilating System	2-14
Cabin Features	2-16
Baggage Area	2-16
Stall Warning	2-16
Finish	2-16
Air Conditioning	2-17
Piper External Power	2-18

BLANK PAGE

DESCRIPTION

AIRPLANE AND SYSTEMS

THE AIRPLANE

The Cherokee 140 is a single-engine, low wing monoplane of all metal construction. It is available in two versions, the Cherokee Cruiser and the Cherokee Flite Liner.

The Cherokee Cruiser, which is the standard model, has a two-place configuration with a third and fourth family seat offered as optional equipment. Economy, comfort and a wide range of options make the Cherokee Cruiser a versatile business or personal airplane.

The Cherokee Flite Liner is basically a standard model Cruiser with optional equipment installed that is tailored for flight instruction. This equipment includes instruments, radio and lights. The Cherokee Flight Liner also has its own distinctive exterior color scheme. The simplicity, stability and dual flight controls make it an especially good instructional airplane.

AIRFRAME

The basic airframe is of aluminum alloy construction. The extremities - wing tips, cowling, tail surfaces - are of durable fiberglass.

The wings are attached to each side of the fuselage by insertion of the butt ends of the respective main spars into a spar box carry-through which is an integral part of the fuselage structure, providing, in effect, a continuous main spar with splices at each side of the fuselage. There are also fore and aft attachments at the rear spar and at an auxiliary front spar.

The wing airfoil section is a laminar flow type, NACA65₂-415 with the maximum thickness about 40% aft of the leading edge. This permits the main spar carry-through structure to be located under the rear seat, providing unobstructed cabin floor space ahead of the rear seat.

ENGINE AND PROPELLER

The Lycoming O-320-E3D engine installed in the Cherokee PA-28-140 is rated at 150 horsepower at 2700 rpm. This engine has a compression ratio of 7 to 1 and requires 80/87 minimum octane fuel. The engine is equipped with direct drive or optional geared drive starter, a 60 ampere alternator, dual magnetos, vacuum pump drive, diaphragm type fuel pump and a float carburetor.

Exhaust gases are carried through a system constructed of heavy gauge stainless steel which incorporates heater shrouds to provide cabin heat, defrosting, and carburetor deicing.

CHEROKEE CRUISER

The propeller used on the PA-28-140 is a Sensenich M74DM fixed-pitch aluminum alloy unit. Its diameter is 74 inches with a standard pitch of 58 inches. All performance figures are based on the standard 58 inch pitch propeller.

Cowling on the Cherokee is designed to cool the engine in all normal flight conditions, including protracted climb, without the use of cowl flaps or cooling flanges.

The throttle quadrant is in the lower center of the instrument panel and contains the throttle and mixture control. A friction lock on the right side of the quadrant prevents creeping of the controls. To the right of the quadrant is the carburetor heat control that provides maximum carburetor heat when fully ON. Air passes through a highly efficient dry type filter when the carburetor heat is OFF.

The Flite Liner incorporates a throttle detent adjusted to the 60% power location for the throttle control. When the throttle is set in this detent, the tachometer needle will match the white radial decal indicating 2265 RPM on the glass of the tachometer at 3500 feet altitude. The arcs of this decal represent 60% power at sea level (2180 RPM) and 7000 feet (2345 RPM). Thus an economical 60% power setting can be easily obtained up to 7000 feet altitude.

LANDING GEAR

The three landing gears use Cleveland 6.00 x 6 wheels, the main wheels are being provided with brake drums and Cleveland single disc hydraulic brake assemblies. The nose wheel and the main gear all use 6.00 x 6 four ply tires with tubes.

The nose gear is steerable through a 60° arc by use of the rudder pedals and brake. A spring device is incorporated in the rudder pedal torque tube assembly to aid in rudder centering and to provide rudder trim. The nose gear steering mechanism also incorporates a bungee device to provide lighter, smoother ground steering and to dampen bumps and shocks during taxiing. The nose gear also includes a shimmy dampener.

The oleo struts are of the air-oil type with a normal extension of 3.25 inches for the nose gear and 4.50 inches for the main gear under normal static (empty weight of airplane plus full fuel and oil) load.

The brakes are actuated by a hand lever and a master cylinder which is located below and near the center of the instrument panel. The toe brakes and the hand lever have their own brake cylinders, but they share a common reservoir. The parking brake is incorporated in the lever brake and is operated by pulling back on the lever and depressing the knob attached to the top of the handle. To release the parking brake, pull back on the brake lever to disengage the catch mechanism; then allow the handle to swing forward.

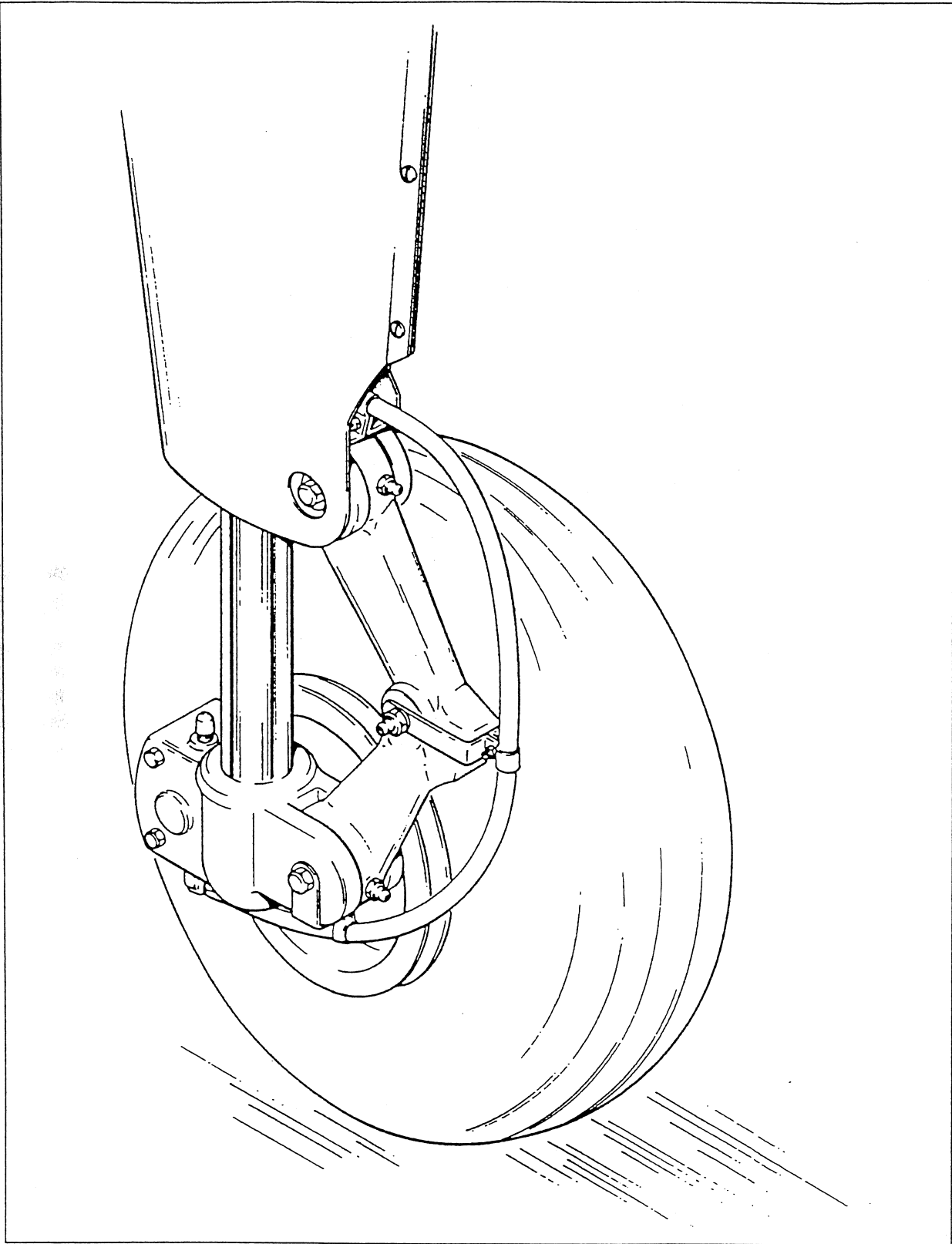

Main Wheel Assembly

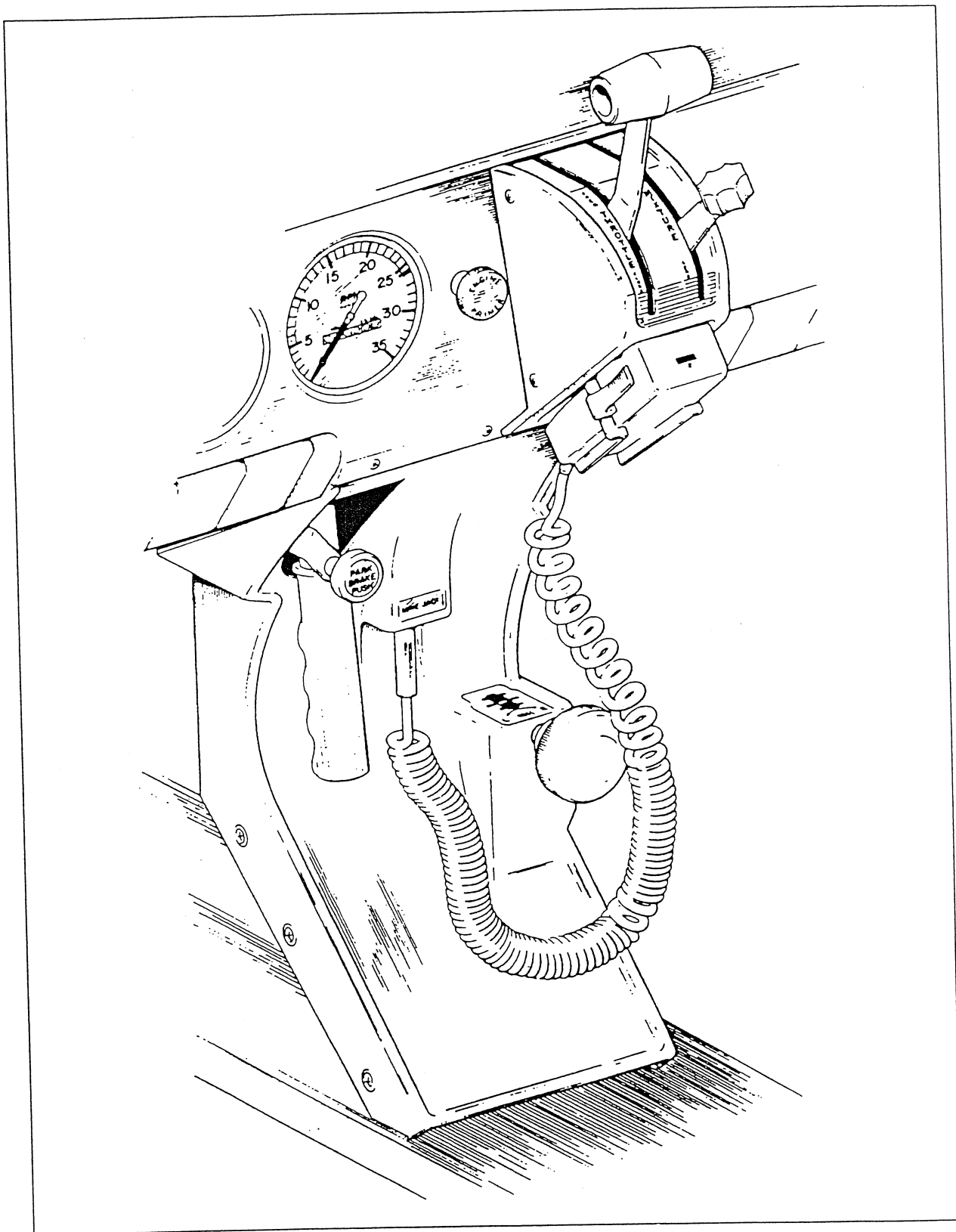

Throttle Quadrant and Console

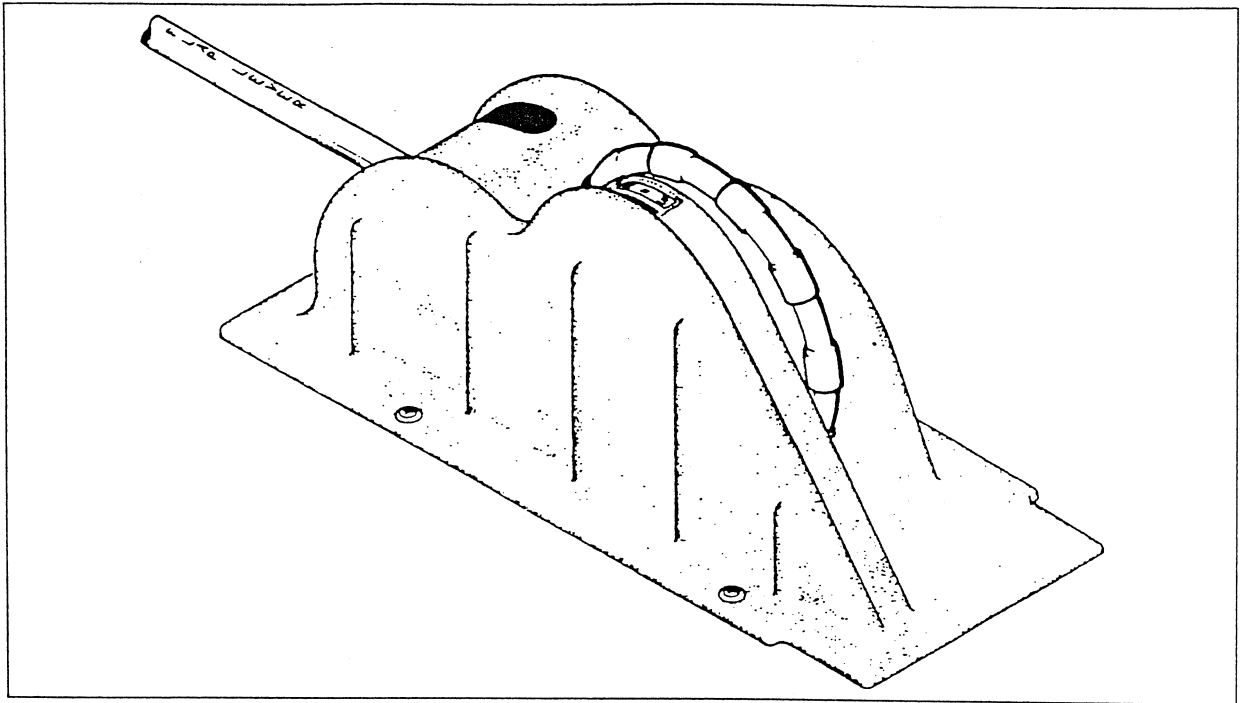

Console

FLIGHT CONTROLS

Dual controls are provided as standard equipment with a cable system used between the controls and the surfaces. The **horizontal tail** is of the all-movable slab type, with an anti-servo tab acting as a longitudinal trim tab. It is actuated by a control wheel on the floor between the front seats. The **stabilator** provides extra stability and control with less size, drag, and weight than conventional tail surfaces. The differential action of the ailerons tends to eliminate adverse yaw in timing maneuvers and reduces the amount of coordination required in normal turns.

The flaps are manually operated, balanced for light operating forces and spring-loaded to return to the up position. A past-center lock incorporated in the actuating linkage holds the flap when it is in the up position so that it may be used as a step on the right side. The flap will not support a step load except when in the full up position, so it must be completely retracted when used as a step. The flaps have three extended positions, 10, 25 and 40 degrees.

FUEL SYSTEM

Fuel is stored in two twenty-five gallon tanks which are secured to the leading edge structure of each wing by screws and nut plates to allow easy removal for service or inspection.

The fuel selector control is located on the left side panel, forward of the pilot's seat. The button on the selector cover must be depressed and held while the handle is moved to the OFF position. The button releases automatically when the handle is moved back into the ON position.

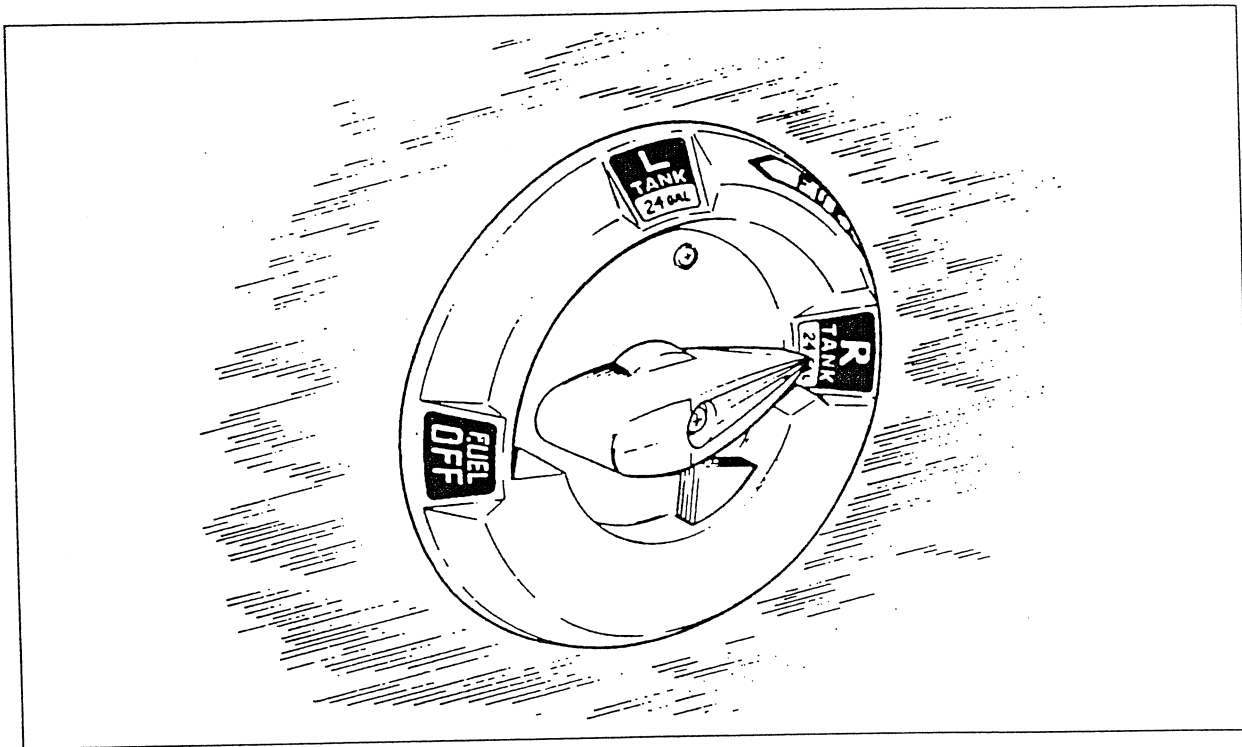

Fuel Selector

To obtain the standard fuel quantity of 36 gallons, fill the tanks to the bottom of the filler neck indicator. To obtain the standard plus the reserve quantity, a total of 50 U.S. gallons, fill the tanks to the top of the filler neck.

An auxiliary electric fuel pump is provided for use in case of failure of the engine driven pump. The electric pump should be on for all takeoffs and landings and when switching tanks.

The fuel strainer is equipped with a quick drain and is located on the front lower left corner of the fire wall. This strainer should be drained during preflight to check for water or sediment and proper fuel (a special bottle is furnished for this operation). To drain the lines from the tanks, the tank selector valve must be switched to each tank in turn, with the electric pump on, and the gascolator drain valve opened. Each tank has an individual quick drain located at the bottom, inboard, rear corner.

Fuel quantity and pressure are indicated on gauges located in the engine gauge cluster on the left side of the instrument panel.

An engine priming system is installed to facilitate starting. The primer pump is located on the immediate left of the throttle quadrant.

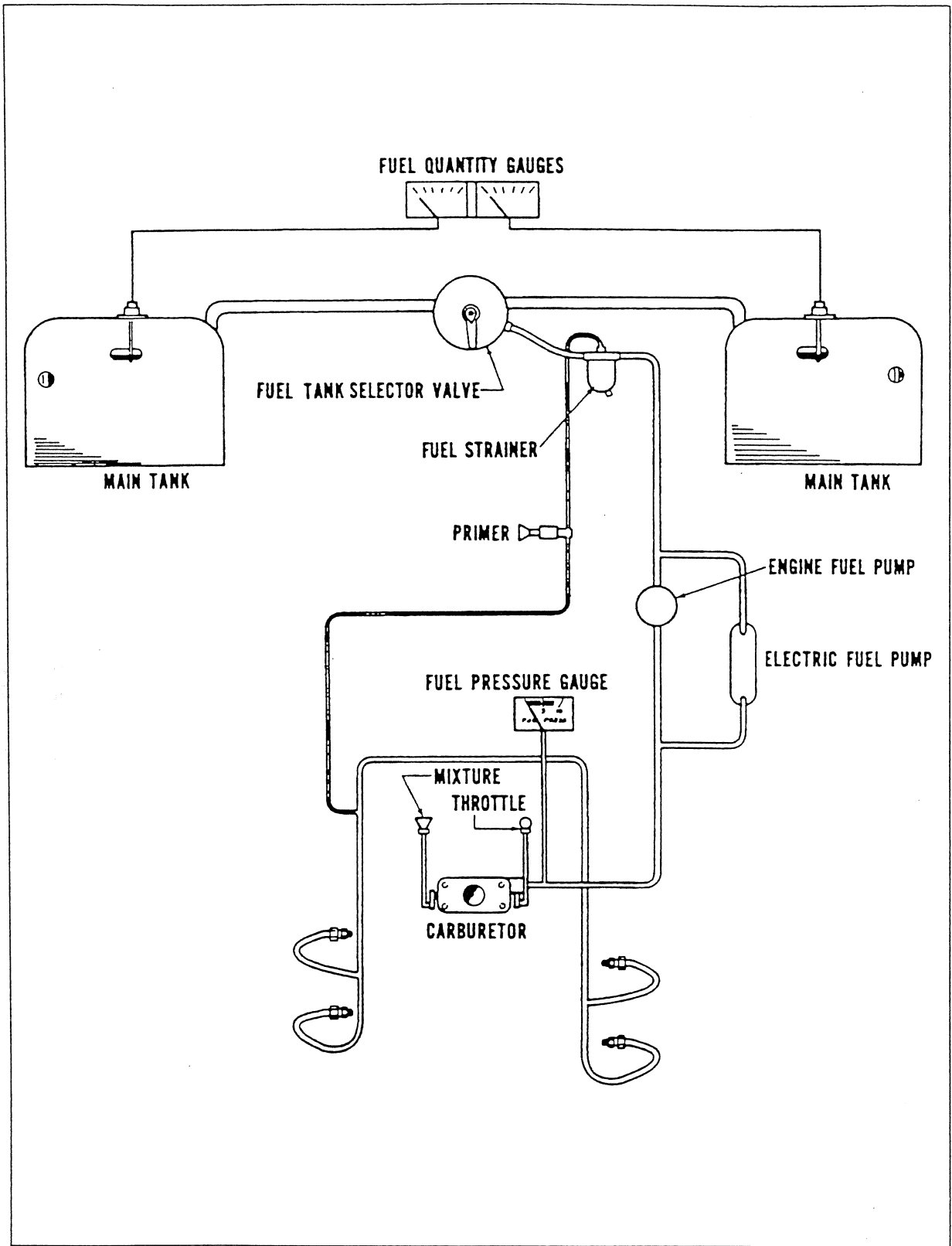

Fuel System Schematic

ELECTRICAL SYSTEM

The **electrical system** includes a 14-volt 60 ampere alternator, battery, voltage regulator, overvoltage relay, and master switch relay. The 12-volt battery and master switch relay are located beneath the baggage compartment floor. Access for service or inspection is obtained by raising the hinged floor panel. The regulator and overvoltage relay are located on the fuselage behind the instrument panel.

Electrical switches are located on the right center instrument panel, and the circuit breakers are located on the lower right instrument panel. A rheostat switch on the right side of the switch panel controls the navigation lights and the intensity of the instrument panel light.

Standard electrical accessories include starter, electric fuel pump, stall warning indicator, cigar lighter, ammeter, and annunciator panel*.

Optional electrical accessories include navigation lights, anti-collision light, landing light, and instrument panel lighting.

The Flite Liner includes as standard electrical accessories: starter, electric fuel pump, stall warning indicator, ammeter, navigation lights, anti-collision light, landing light, instrument panel lights, and annunciator panel*.

WARNING

Anti-collision lights should not be operating when flying through cloud, fog or haze, since the reflected light can produce spatial disorientation. Strobe lights should not be used in close proximity to the ground such as during taxiing, takeoff or landing.

The annunciator panel* includes alternator and low oil pressure indicator lights. When the optional gyro system is installed, the annunciator panel also includes a low vacuum indicator light. The annunciator panel lights are provided only as a warning to the pilot that a system may not be operating properly, and that he should check and monitor the applicable system gauge to determine when or if any necessary action is required.

Circuit provisions are made to handle a full complement of communications and navigational equipment.

The **alternator system** offers many advantages over the generator system. The main advantage is full electrical power output at much lower engine RPM which results in improved radio and electrical equipment operation. Since the alternator output is available all the time, the battery will be charging almost continuously. This will make cold weather starting easier.

In generator systems, the ammeter indicates battery discharge. In the Cherokee electrical system the ammeter displays in amperes the load placed on the alternator. With all electrical equipment except the master switch in the OFF position, the ammeter will indicate the amount of charging current demanded by the battery. As each item of electrical equipment is turned on, the current will increase to a total appearing on the ammeter. This total includes the battery. The maximum continuous load for night flight with radios on is about 30 amperes. This 30 ampere value plus approximately 2 amperes for a fully charged battery will appear continuously under these conditions. Do not take off with a fully discharged battery as 3 volts are needed to excite the alternator.

*Serial nos. 7525001 and up

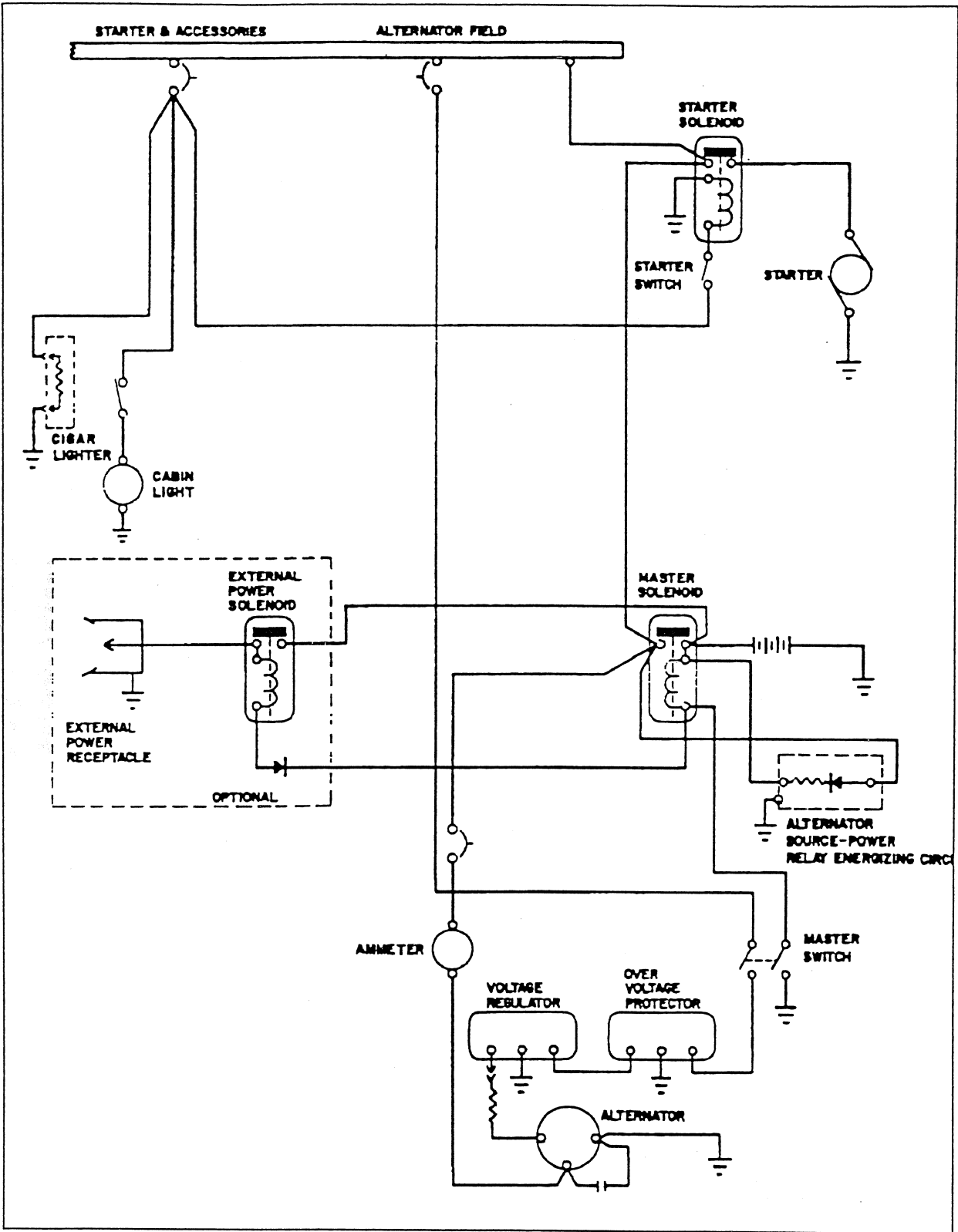

Alternator and Starter Schematic (Ser. nos. 7425001 through 7425454)

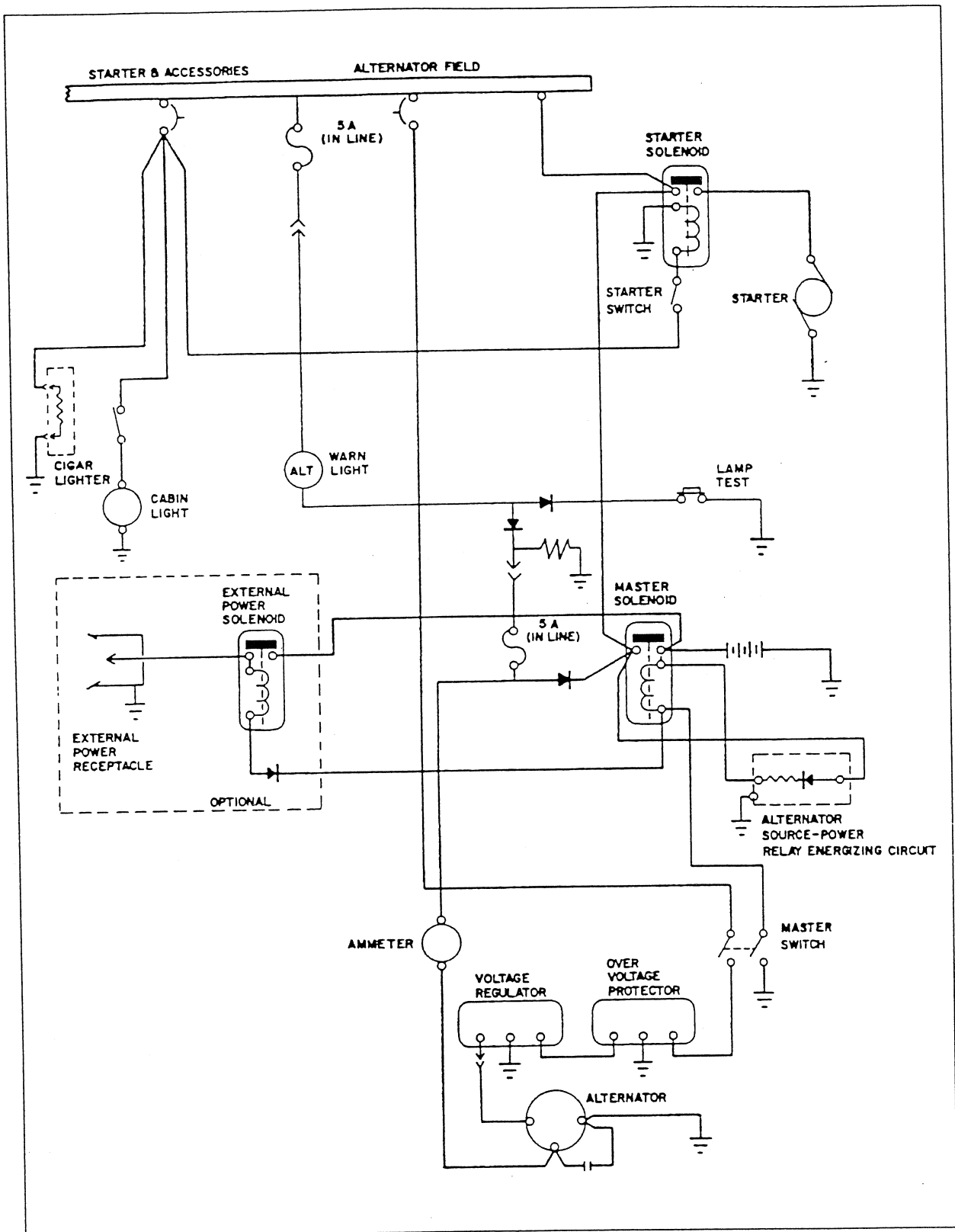

Alternator and Starter Schematic (Ser. nos. 7525001 and up)

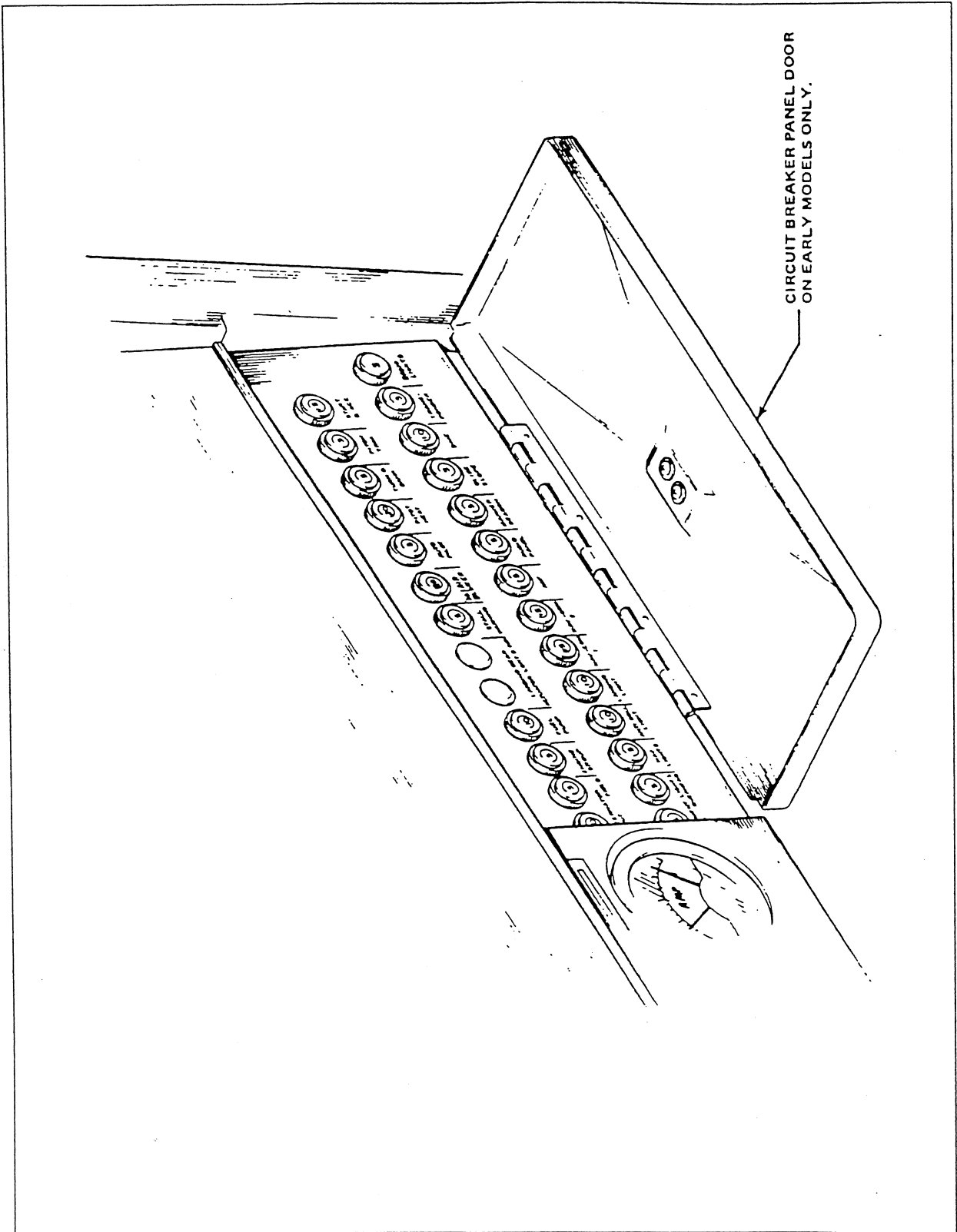

CIRCUIT BREAKER PANEL DOOR
ON EARLY MODELS ONLY.

Circuit Breaker Panel

CHEROKEE CRUISER

The **master switch** is a split switch with the left half operating the master relay and the right half energizing the alternator. The switch is interlocked so that the alternator cannot be operated without the battery. For normal operation, be sure both halves are turned on.

Maintenance on the alternator should prove to be a minor factor. Should service be required, contact the local Piper Dealer.

VACUUM SYSTEM

The **vacuum system** is designed to operate the air driven gyro instruments. This includes the directional and attitude gyros when installed. The system consists of an engine driven vacuum pump, a vacuum regulator, a filter and the necessary plumbing.

The **vacuum pump** is a dry type pump which eliminates the need for an air/oil separator and its plumbing. A shear drive protects the pump from damage. If the drive shears, the gyros will become inoperative.

The **vacuum gauge**, mounted on the right instrument panel to the right of the radios, provides valuable information to the pilot about the operation of the vacuum system. A decrease in pressure in a system that has remained constant over an extended period may indicate a dirty filter, dirty screens, possibly a sticking vacuum regulator or leak in system (a low vacuum indicator light is provided in the annunciator panel*). Zero pressure would indicate a sheared pump drive, defective pump, possibly a defective gauge or collapsed line. In the event of any gauge variation from the norm, the pilot should have a mechanic check the system to prevent possible damage to the system components or eventual failure of the system.

A **vacuum regulator** is provided in the system to protect the gyros. The valve is set so the normal vacuum reads $5.0 \pm .1$ inches of mercury, a setting which provides sufficient vacuum to operate all the gyros at their rated RPM. Higher settings will damage the gyros and with a low setting the gyros will be unreliable. The regulator is located behind the instrument panel.

INSTRUMENT PANEL

The **instrument panel** of the Cherokee is designed to accommodate the customary advanced flight instruments and the normally required power plant instruments. The artificial horizon and directional gyro are vacuum operated through use of a vacuum pump installed on the engine, while the turn and bank instrument is electrically operated. A vacuum gauge is mounted on the far right side of the instrument panel. A natural separation of the **flight group** and **power group** is provided by the placement of the flight group in the upper instrument panel and the power group in the center and lower instrument panels. The radios and circuit breakers are on the right hand instrument panel, and extra circuits are provided for a complete line of optional radio equipment. The microphone is located on the console. An annunciator panel is mounted in the upper instrument panel to warn the pilot of a possible malfunction in the alternator, oil pressure or vacuum systems*.

*Serial nos. 7525001 and up

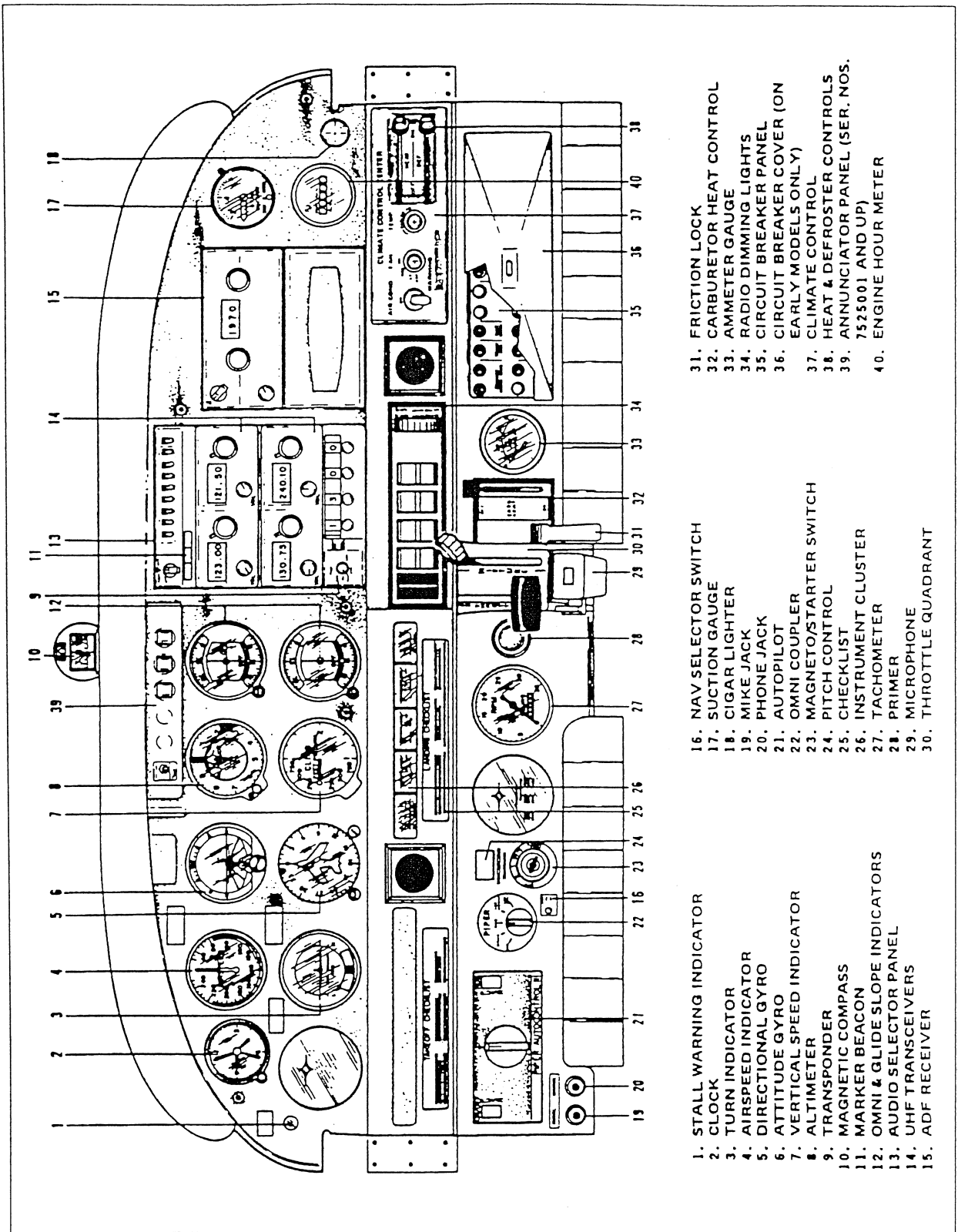

Instrument Panel

THIS PAGE INTENTIONALLY LEFT BLANK

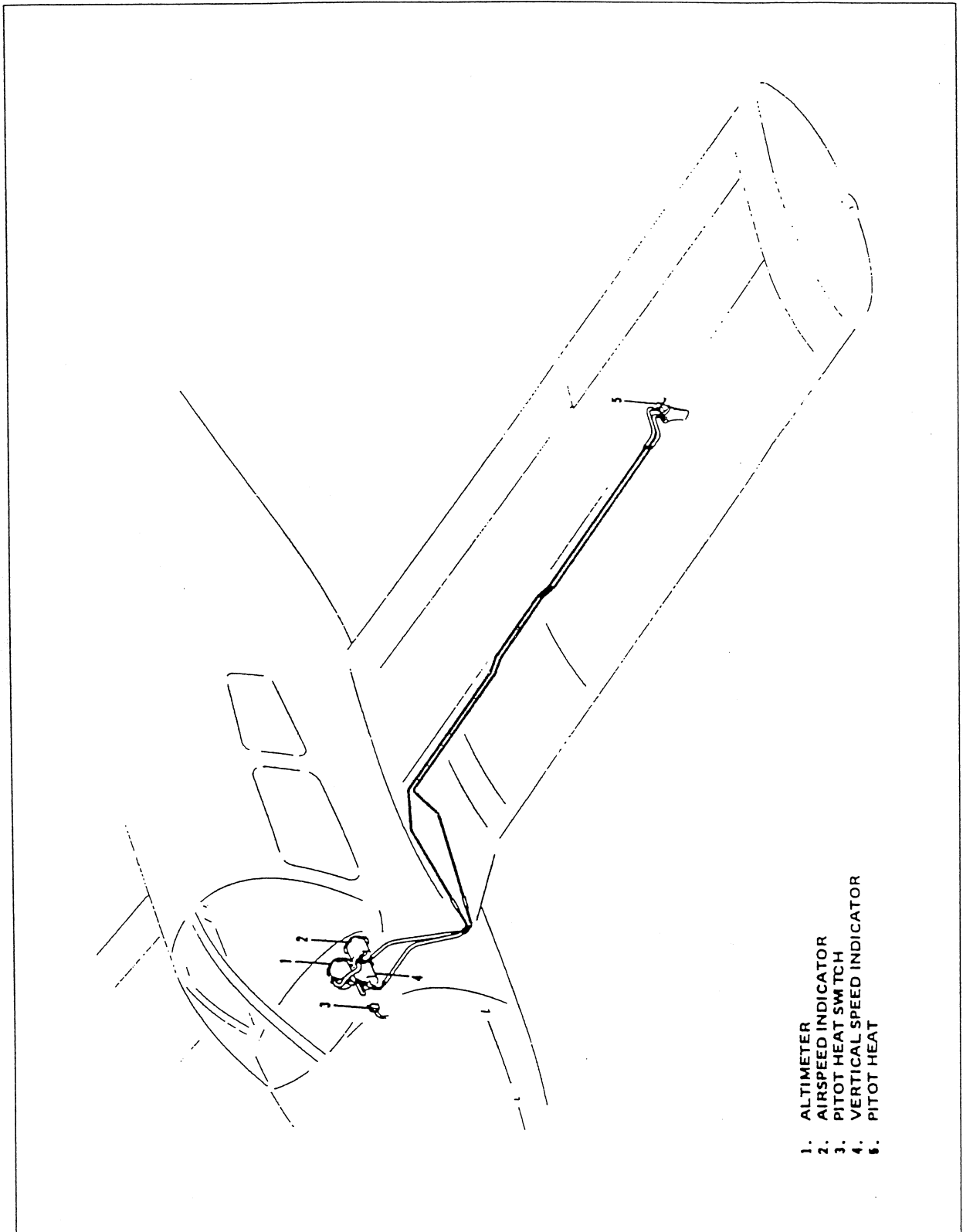

Pitot-Static System

PITOT-STATIC SYSTEM

The system supplies both pitot and static pressure for the airspeed indicator, altimeter and vertical speed indicator (when installed).

Pitot and static pressure are picked up by the pitot head on the bottom of the left wing.

To prevent bugs and water from entering the pitot and static pressure holes, when the airplane is parked, a cover should be placed over the pitot head. A partially or completely blocked pitot head will give erratic or zero readings on the instruments.

NOTE

During the preflight, check to make sure the pitot cover is removed.

HEATING AND VENTILATING SYSTEM

Heat for the cabin interior and the defroster system is provided by a heater muff attached to the exhaust system. The amount of heat desired can be regulated with the controls located on the far right side of the instrument panel. If unusual odors are noticed, the heat should be shut off and the system inspected for leaks. The airflow may be regulated between the front and rear seats by the use of the levers located on top of the heat ducts next to the control console.

CAUTION

When cabin heat is operated, heat duct surface becomes hot. This could result in burns if arms or legs are placed too close to heat duct outlets or surface.

Fresh air inlets are located in the leading edge of the wing at the intersection of the tapered and straight sections. A large adjustable outlet is located on the side of the cabin near the floor at each seat location; overhead air outlets are offered as optional equipment. Cabin air is exhausted through an outlet located below the rear seat floor panel. A cabin air blower, which helps to distribute fresh air through the cabin, is available as optional equipment when air conditioning is not installed. This blower is operated by a "FAN" switch with 4 positions - OFF, "LOW," "MED," or "HIGH."

On the Flite Liner, overhead air outlets are not offered as optional equipment.

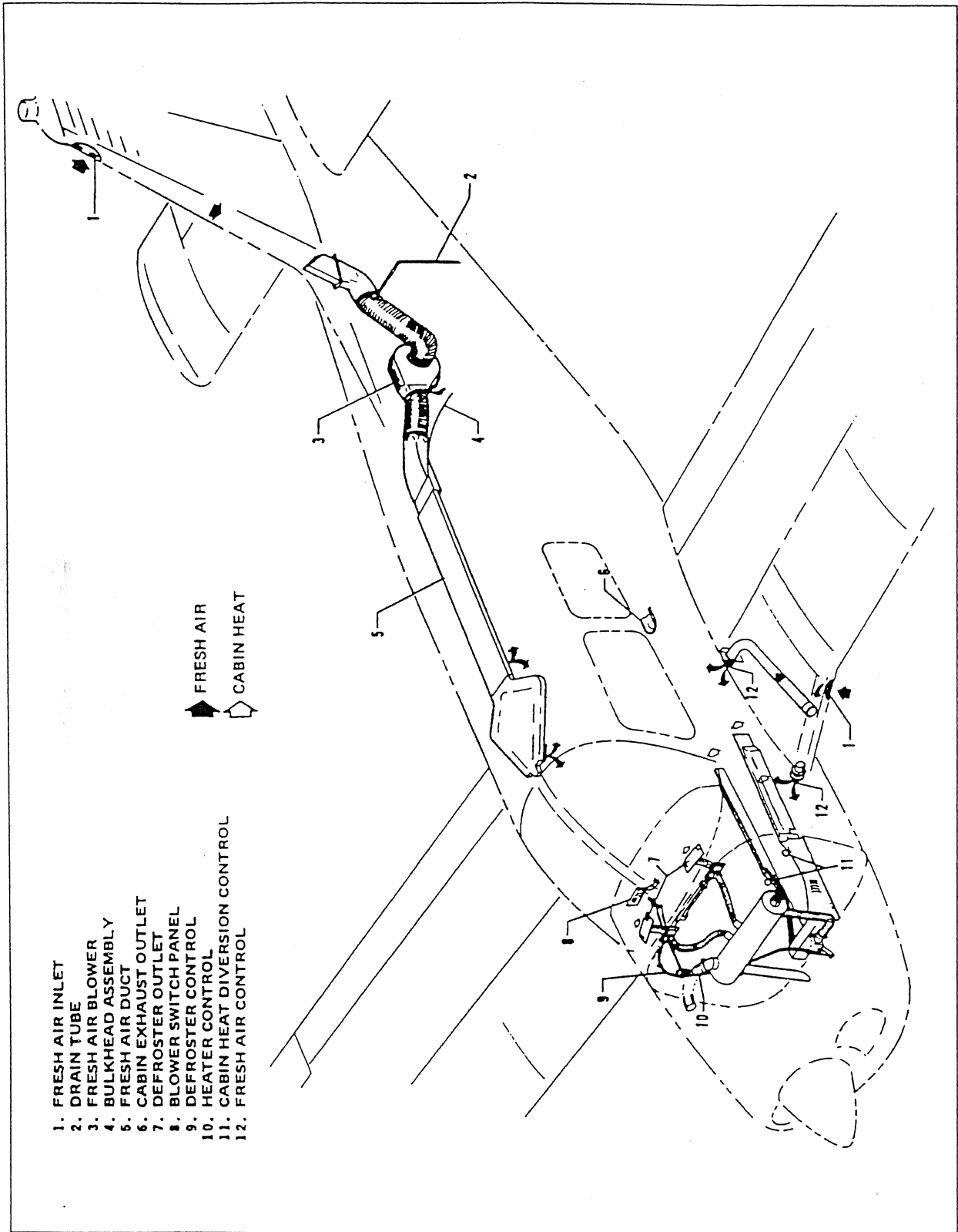

Heating and Ventilating System

CHEROKEE CRUISER

CABIN FEATURES

For ease of entry and exit and pilot-passenger comfort, the front seats recline and are adjustable fore and aft. A family seat installation which provides two additional seats is available. Each family seat is capable of carrying a full size adult, which gives the Cherokee 140 4-place capability. Optional headrests and vertically adjustable front seats are also available.

A single strap shoulder harness controlled by an inertia reel is standard equipment for the front seats, and is offered as an option for the rear seats when they are installed. The shoulder strap is routed over the shoulder adjacent to the windows and attached to the lap strap in the general area of the occupant's inboard hip.

A check of the inertia reel mechanism is made by pulling sharply on the strap. The reel will lock in place under this test and prevent the strap from extending. Under normal movement the strap will extend and retract as required.

The Flite Liner has all of the above features, except there is only one radio installed, and optional headrests, vertically adjustable front seats, and family seats are not available.

BAGGAGE AREA

A 22 cubic foot luggage compartment is located behind the seats in the two-place model and is accessible from the cabin. Maximum baggage capacity is 200 pounds.

NOTE

It is the pilot's responsibility to be sure when the baggage is loaded that the aircraft C.G. falls within the allowable C.G. Range. (See Weight and Balance Section.)

STALL WARNING

An approaching stall is indicated by a stall warning indicator which is activated between five and ten miles per hour above stall speed. Mild airframe buffeting and gentle pitching may also precede the stall. Stall speeds are shown on graphs in the Performance Charts Section. The stall warning indicator is a red warning light on the left side of the instrument panel on earlier models and a continuous sounding horn located behind the instrument panel on later models. The stall warning indicator is activated by a lift detector installed on the leading edge of the left wing. During preflight, the stall warning system should be checked by turning the master switch "ON," lifting the detector and checking to determine if the indicator is actuated.

FINISH

All exterior surfaces are primed with etching primer and finished with a durable acrylic lacquer in a variety of tasteful colors to suit individual owners. To keep a new look, economy size "Touch-Up" spray paint cans are available from Piper Dealers.

AIR CONDITIONING*

The air conditioning system is a recirculating air system. The major items include; evaporator, condenser, compressor, blower, switches and temperature controls.

The evaporator is located behind the left rear side of the baggage compartment. This cools the air that is used for air conditioning.

The condenser is mounted on a retractable scoop located on the bottom of the fuselage and to the rear of the baggage compartment area. The scoop extends when the air conditioner is "ON" and retracts to a flush position when the system is "OFF."

The compressor is mounted on the forward right underside of the engine. It has an electric clutch which automatically engages or disengages the compressor to the belt drive system of the compressor.

An electrical blower is mounted on the aft side of the rear cabin panel. Air from the baggage area is drawn through the evaporator by the blower and distributed through an overhead duct to individual outlets located adjacent to each occupant.

The switches and temperature control are located on the lower right side of the instrument panel in the climate control center panel. The temperature control regulates the temperature of the cabin. Turn the control clockwise for increased cooling, counterclockwise for decreased cooling.

Located inboard of the temperature control is the fan speed switch and the air conditioning "ON-OFF" switch. The fan can be operated independently of the air conditioning. However, it must be on for air conditioner operation. Turning either switch off will disengage the compressor clutch and retract the condenser door. Cooling air should be felt within one minute after the air conditioner is turned on.

NOTE

If the system is not operating in 5 minutes, turn the system "OFF" until the fault is corrected.

The "FAN" switch allows operation of the fan with the air conditioner turned "OFF" to aid cabin air circulation if desired. A "LOW," "MED" or "HIGH" flow of air can be selected to the air conditioner outlets located in the overhead duct. The outlets can be adjusted or turned off by each occupant to regulate individual cooling effect.

The "DOOR OPEN" indicator light is located to the left of the radio stack in front of the pilot. The light illuminates whenever the condenser door is open and remains on until the door is closed.

A circuit breaker located on the circuit breaker panel protects the air conditioning electrical system.

*Optional equipment

CHEROKEE CRUISER

Whenever the throttle is in the full throttle position, it actuates a micro switch which disengages the compressor and retracts the scoop. This is done to obtain maximum power and maximum rate of climb. The fan continues to operate and the air will remain cool for approximately one minute. When the throttle is retarded approximately 1/4 inch, the clutch will engage and the scoop will extend, again supplying cool, dry air.

PIPER EXTERNAL POWER*

An optional starting installation known as Piper External Power (PEP) is accessible through a receptacle located on the right side of the fuselage aft of the wing. An external battery can be connected to the socket, thus allowing the operator to crank the engine without having to gain access to the airplane's battery. This installation is not available on the Flite Liner.

*Optional equipment

AIRPLANE FLIGHT MANUAL

Log of Revisions	3-iii
Limitations	3-1
Procedures	3-7
Performance	3-9
Supplements	3-11

BLANK PAGE

TABLE OF CONTENTS

Log of Revisions.....3-iii

SECTION I

Limitations3-1

- A. Engines3-1
- B. Fuel.....3-1
- C. Propellers.....3-1
- D. Power Instruments.....3-1
- E. Airspeed Limitations and Airspeed Instrument Markings
(Calibrated Airspeed) (MPH).....3-2
- F. Maximum Weight.....3-2
- G. Baggage Capacity.....3-2
- H. C. G. Range.....3-2
- I. Maneuvers.....3-3
- J. Placards.....3-3
- K. Air Conditioned Airplanes.....3-6

SECTION II

Procedures3-7

SECTION III

Performance3-9

SECTION IV

Supplements.....3-11

- A. Electric Pitch Trim Installation3-15
- B. AutoFlite II Installation.....3-16
- C. Air Conditioning Installation3-18
- D. Piper AutoControl III and/or AutoControl IIIB Installation.....3-19

THIS PAGE INTENTIONALLY LEFT BLANK

AIRPLANE FLIGHT MANUAL LOG OF REVISIONS

Revision	Revised Pages	Description and Revision	FAA Approved Date
1	Title	Added PAC Approval Form. (NOTE: AIRCRAFT DELIVERED WITH MANUALS PRIOR TO THIS REVISION DO NOT REQUIRE THIS REVISION.)	<i>D. H. Trompler</i> D. H. Trompler May 29, 1974
2	3-i 3-3 3-4 3-5 3-11 3-19, 3-20, 3-21, 3-22	Added item G. Installation of Piper Auto-Control IIIB to Supplements. Revised Item I. 2. a., I. 2. b., and J. 1. Revised Item J. 2. Revised Items 1. and 2. Added Item G. Installation of Piper Auto-Control IIIB. Added pages (AutoControl IIIB Supplement info added).	<i>D. H. Trompler</i> D. H. Trompler June 13, 1974
3	3-i 3-5 3-11 3-13 3-14 3-15 3-16 3-17 3-18 3-19 3-20	Under Supplements - deleted existing Items A., B. and E.; revised remaining Items. Added "Spins Prohibited" to Item 2. under Maneuvers Placard for Utility Category with Air Cond. or Vent. Blower. Deleted existing Items A., B. and E.; revised remaining Items. Deleted Item A. Electric Pitch Trim Installation (Without Pitch Trim Switch). Deleted Item B. AutoFlite Installation. Revised existing Item letter (C. to A.); deleted (With Pitch Trim Switch). Revised existing Item letter (D. to B.). Deleted Item E. AutoControl III Installation. Revised existing Item Letter (F. to C.). Revised existing Item letter (G. to D.); added AutoControl III to Title. Deleted IIIB designation from Items c. (1) and (2).	<i>Ward Evans</i> Ward Evans Nov. 1, 1974 <i>Ward Evans</i> Ward Evans Nov. 27, 1975 <i>Ward Evans</i> Ward Evans April 19, 1976
4	3-22	Revised item c. (1).	<i>Ward Evans</i> Ward Evans Nov. 27, 1975
5	3-1	Revised item B. Fuel.	<i>Ward Evans</i> Ward Evans April 19, 1976

AIRPLANE FLIGHT MANUAL LOG OF REVISIONS (cont)

Revision	Revised Pages	Description and Revision	FAA Approved Date
6	Title	Added Applicable Serial Numbers. (NOTE: AIRCRAFT DELIVERED WITH MANUALS PRIOR TO THIS REVISION DO NOT REQUIRE THIS REVISION.)	<p><i>Ward Evans</i> Ward Evans Sept. 30, 1977</p>
7	3-1 3-22	Revised item B. Fuel. Added ending serial number effectivity.	<p><i>Ward Evans</i> Ward Evans July 13, 1984</p>

SECTION I
LIMITATIONS

The following limitations must be observed in the operation of this airplane:

A. ENGINE

Lycoming O-320-E2A or O-320-E3D

ENGINE LIMITS

For all operations 2700 RPM, 150 HP

B. FUEL

AVGAS ONLY

80/87 Octane Aviation Fuel Minimum Grade

C. PROPELLER

Sensenich M74DM or 74DM6, Maximum diameter 74 inches. minimum diameter 72-1/2 inches. Static RPM at maximum permissible throttle setting: Not under 2150, not over 2425 for max. allowable weight of 1950 lbs. Not under 2275, not over 2425 for max. allowable weight of 2150 lbs. No additional tolerance permitted.

D. POWER INSTRUMENTS

OIL TEMPERATURE

Green Arc (Normal Operating Range)	75°F to 245°F
Red Line (Maximum)	245° F

OIL PRESSURE

Green Arc (Normal Operating Range)	60 PSI to 90 PSI
Yellow Arc (Caution Range)	25 PSI to 60 PSI
Red Line (Minimum)	25 PSI
Red Line (Maximum)	90 PSI

FUEL PRESSURE

Green Arc (Normal Operating Range)	.5 PSI to 8 PSI
Red Line (Minimum)	.5 PSI
Red Line (Maximum)	8 PSI

TACHOMETER

Green Arc (Normal Operating Range)	500 to 2700 RPM
Red Line (Maximum Continuous Power)	2700 RPM

CHEROKEE CRUISER

E. AIRSPEED LIMITATIONS AND AIRSPEED INSTRUMENT MARKINGS (Calibrated Airspeed)

NEVER EXCEED	171 MPH
MAXIMUM STRUCTURAL CRUISE	140 MPH
MANEUVERING	129 MPH
FLAPS EXTENDED	115 MPH
MAXIMUM POSITIVE LOAD FACTOR	(Normal Category) 3.8
MAXIMUM POSITIVE LOAD FACTOR	(Utility Category) 4.4
MAXIMUM NEGATIVE LOAD FACTOR	No inverted maneuvers approved

AIRSPEED INSTRUMENT MARKINGS

Red Radial Line (Never Exceed)	171 MPH (148 KTS)
Yellow Arc (Caution Range) (Smooth Air Only)	140 MPH to 171 MPH (121 KTS to 148 KTS)
Green Arc (Normal Operating Range)	64 MPH to 140 MPH (56 KTS to 121 KTS)
White Arc (Flap Down Range)	55 MPH to 115 MPH (48 KTS to 100 KTS)

F. MAXIMUM WEIGHT

Utility Category	1950 LBS
Normal Category	2150 LBS

G. BAGGAGE CAPACITY

At Fuselage Station +117	200 LBS
At Fuselage Station +133 when modified in accordance with Piper drawing 66671	100 LBS

H. C. G. RANGE

The datum used is 78.4 inches ahead of wing leading edge at the intersection of the straight and tapered section.

1. Normal Category

<u>Weight</u> <u>(Pounds)</u>	<u>Forward Limit</u> <u>(In. Aft of Datum)</u>	<u>Rearward Limit</u> <u>(In. Aft of Datum)</u>
2150	88.4	95.9
1975	85.9	95.9
1650	84.0	95.9

2. Utility Category

<u>Weight</u> <u>(Pounds)</u>	<u>Forward Limit</u> <u>(In. Aft of Datum)</u>	<u>Rearward Limit</u> <u>(In. Aft of Datum)</u>
1950	85.8	86.5
1650	84.0	86.5

Straight Line variation between given points.

NOTE

It is the responsibility of the airplane owner and/or the pilot to insure that the airplane is properly loaded. See Weight and Balance Section for loading information.

I. MANEUVERS

1. Normal Category - All acrobatic maneuvers including spins prohibited.
2. Utility Category - Approved maneuvers for Utility Category only.

a.	Models Without Air Conditioning or Ventilation Blower	Entry Speed
	Spins (Flaps Up)	Stall
	Steep Turns	129 MPH
	Lazy Eights	129 MPH
	Chandelles	129 MPH
b.	Models With Air Conditioning or Ventilation Blower	Entry Speed
	Steep Turns	129 MPH
	Lazy Eights	129 MPH
	Chandelles	129 MPH

J. PLACARDS

In full view of the pilot:

1. Models Without Air Conditioning or Ventilation Blower
 "THIS AIRPLANE MUST BE OPERATED AS A NORMAL OR UTILITY CATEGORY AIRPLANE IN COMPLIANCE WITH THE OPERATING LIMITATIONS STATED IN THE FORM OF PLACARDS, MARKINGS AND MANUALS.

ALL MARKINGS AND PLACARDS ON THIS AIRPLANE APPLY TO ITS OPERATION AS UTILITY CATEGORY AIRPLANE. FOR NORMAL AND UTILITY CATEGORY OPERATIONS, REFER TO THE AIRPLANE FLIGHT MANUAL.

FOR SPIN RECOVERY, USE FULL RUDDER AGAINST SPIN, FOLLOWED IMMEDIATELY BY FORWARD WHEEL.

NO ACROBATIC MANEUVERS (INCLUDING SPINS) ARE APPROVED FOR NORMAL CATEGORY OPERATIONS."

CHEROKEE CRUISER

2. Models With Air Conditioning or Ventilation Blower

“THIS AIRPLANE MUST BE OPERATED AS A NORMAL OR UTILITY CATEGORY AIRPLANE IN COMPLIANCE WITH THE OPERATING LIMITATIONS STATED IN THE FORM OF PLACARDS, MARKINGS AND MANUALS.

ALL MARKINGS AND PLACARDS ON THIS AIRPLANE APPLY TO ITS OPERATION AS A UTILITY CATEGORY AIRPLANE. FOR NORMAL AND UTILITY CATEGORY OPERATIONS, REFER TO THE AIRPLANE FLIGHT MANUAL.

NO ACROBATIC MANEUVERS ARE APPROVED FOR NORMAL CATEGORY OPERATIONS. SPINS ARE PROHIBITED FOR BOTH NORMAL AND UTILITY CATEGORIES.”

In full view of the pilot, the following takeoff and landing check lists will be installed:

TAKEOFF CHECK LIST

Fuel on proper tank	Mixture set	Fasten belts/harness
Electric fuel pump on	Seat backs erect	Trim tab - set
Engine gauges checked		Controls - free
Flaps - set		Door - latched
Carb heat off		Air Conditioner - off

LANDING CHECK LIST

Fuel on proper tank		Flaps - set (115 mph)
Mixture rich	Seat backs erect	Fasten belts/harness
Electric fuel pump on		Air Conditioner - off

The “AIR COND OFF” item in the above takeoff and landing check lists is mandatory for air conditioned aircraft only.

In full view of the pilot, in the area of the air conditioner control panel when air conditioner is installed:

“WARNING - AIR CONDITIONER MUST BE OFF TO INSURE NORMAL TAKEOFF CLIMB PERFORMANCE.”

Adjacent to upper door latch:

“ENGAGE LATCH BEFORE FLIGHT.”

On aft side of baggage compartment:

“UTILITY CATEGORY OPERATION - NO BAGGAGE OR AFT PASSENGERS ALLOWED. NORMAL CATEGORY OPERATION - SEE AIRPLANE FLIGHT MANUAL WEIGHT AND BALANCE SECTION FOR BAGGAGE AND AFT PASSENGER LIMITATIONS.”

On the instrument panel in full view of the pilot when the oil cooler winterization kit is installed:

“OIL COOLER WINTERIZATION PLATE TO BE REMOVED WHEN AMBIENT TEMPERATURE EXCEEDS 50°F.”

On the instrument panel in full view of the pilot when the AutoFlite is installed:

“FOR HEADING CHANGES: PRESS DISENGAGE SWITCH ON CONTROL WHEEL. CHANGE HEADING. RELEASE DISENGAGE SWITCH.”

In full view of the pilot:

UTILITY CATEGORY ONLY

ACROBATIC MANEUVERS ARE LIMITED TO THE FOLLOWING:

1. Models Without Air Conditioning or Ventilation Blower

	Entry Speed
SPINS (FLAPS UP)	STALL
STEEP TURNS	129 MPH
LAZY EIGHTS	129 MPH
CHANDELLES	129 MPH

2. Models With Air Conditioning or Ventilation Blower

	Entry Speed
SPINS PROHIBITED	
STEEP TURNS	129 MPH
LAZY EIGHTS	129 MPH
CHANDELLES	129 MPH

CHEROKEE CRUISER

In full view of the pilot:

“ROUGH AIR OR MANEUVERING SPEED - 129 MPH.”

On the instrument panel in full view of the pilot when the AutoFlite II is installed:

“TURN AUTOFLITE ON. ADJUST TRIM KNOB FOR MINIMUM HEADING CHANGE. FOR HEADING CHANGE, PRESS DISENGAGE SWITCH ON CONTROL WHEEL, CHANGE HEADING, RELEASE SWITCH. ROTATE TURN KNOB FOR TURN COMMANDS. PUSH TURN KNOB IN TO ENGAGE TRACKER. PUSH TRIM KNOB IN FOR HI SENSITIVITY. LIMITATIONS AUTOFLITE OFF FOR TAKEOFF AND LANDING.”

On the instrument panel in full view of the pilot when the supplementary white strobe lights are installed:

“WARNING - TURN OFF STROBE LIGHTS WHEN TAXIING IN VICINITY OF OTHER AIRCRAFT, OR DURING FLIGHT THROUGH CLOUD, FOG OR HAZE.”

- K. AIR CONDITIONED AIRPLANES
Air Conditioner must be off for takeoff and landing.

SECTION II
PROCEDURES

1. The stall warning system is inoperative with the master switch off.
2. The electric fuel pump must be on for both takeoff and landing.
3. Except as noted above, all operating procedures for this airplane are normal.
4. Air Conditioned Models only: Warning - The air conditioner must be off to insure normal takeoff performance.

THIS PAGE INTENTIONALLY LEFT BLANK

SECTION III
PERFORMANCE

All performance is given for a weight of 2150 pounds.

Loss of altitude during stalls can be as great as 200 feet, depending on configuration and power.

Stalling speeds, in mph, power off, versus angle of bank (Calibrated Airspeed):

Angle of Bank	0°	20°	40°	50°	60°
Flaps Up	64	66	73	80	91
Flaps Down	55	-	-	-	-

Air Conditioner Models only:

When the full throttle position is not used or in the event of a malfunction which causes the compressor to operate and the condenser door to remain extended, a decrease in rate of climb of as much as 100 fpm can be expected at all altitudes.

THIS PAGE INTENTIONALLY LEFT BLANK

SECTION IV
SUPPLEMENTS

NOTE

A FLIGHT MANUAL SUPPLEMENT IS REQUIRED TO BE IN THE AIRPLANE FLIGHT MANUAL ONLY IF THE EQUIPMENT WHICH IS THE SUBJECT OF THE SUPPLEMENT IS INSTALLED.

- A. Electric Pitch Trim Installation
- B. AutoFlite II Installation
- C. Air Conditioner Installation
- D. Piper AutoControl III and/or AutoControl IIIB Installation

THIS PAGE INTENTIONALLY LEFT BLANK

A. ELECTRIC PITCH TRIM INSTALLATION

The following emergency information applies in case of electric pitch trim malfunction:

1. In case of malfunction, disengage electric pitch trim by pushing pitch trim switch on instrument panel to OFF position.
2. In an emergency, electric pitch trim may be overpowered using manual pitch trim.
3. In cruise configuration, malfunction results in 10° pitch change and 30 ft altitude variation.

CHEROKEE CRUISER

B. AUTOFLITE II INSTALLATION

1. LIMITATIONS

AutoFlite off for takeoff and landing.

2. PROCEDURES

a. Normal Operation

Refer to Manufacturer's Operation Manual.

b. Emergency Operation

- (1) In case of malfunction, PRESS disconnect switch on pilot's control wheel.
- (2) Rocker switch on instrument panel - OFF.
- (3) Unit may be overpowered manually.
- (4) In cruise configuration malfunction, 3 seconds delay results in 60° bank, and 100 ft altitude loss.
- (5) In approach configuration malfunction, 1 second delay results in 10° bank and 0 ft altitude loss.

THIS PAGE INTENTIONALLY LEFT BLANK

C. AIR CONDITIONER INSTALLATION

Prior to takeoff, the air conditioner should be checked for proper operation as follows:

1. Check aircraft master switch on.
2. Turn the air conditioner control switch to "ON" and the fan switch to one of the operating positions - the "AIR COND DOOR OPEN" warning light will turn on, thereby indicating proper air conditioner condenser door actuation.
3. Turn the air conditioner control switch to OFF - the "AIR COND DOOR OPEN" warning light will go out, thereby indicating the air conditioner condenser door is in the up position.
4. If the "AIR COND DOOR OPEN" light does not respond as specified above, an air conditioner system or indicator bulb malfunction is indicated and further investigation should be conducted prior to flight.

The above operational check may be performed during flight if an in flight failure is suspected.

WARNING

The air conditioner must be off to insure normal takeoff performance.

D. PIPER AUTOCONTROL III AND/OR AUTOCONTROL IIIB INSTALLATION

1. LIMITATIONS

- a. Autopilot OFF during takeoff and landing.
- b. Autopilot use prohibited above 140 MPH CAS.

2. PROCEDURES

a. PREFLIGHT

(1) Roll Section

- (a) Place Radio Coupler in "Heading" mode and place A/P ON/OFF switch in the "ON" position to engage roll section. Rotate roll command knob Left and Right and observe control wheel describes a corresponding Left and Right turn, then center knob.
- (b) Set proper D.G. Heading on D.G. and turn Heading Indice to aircraft heading. Engage "Heading" mode switch and rotate Heading Indice right and left. Aircraft control wheel should turn same direction as Indice. While D.G. indice is set for a left turn, grasp control wheel and override the servo to the right. Repeat in opposite direction for right turn.
- (c) If VOR signal available check Omni mode on Radio Coupler by swinging Omni needle left and right slowly. Observe that control wheel rotates in direction of needle movement.
- (d) Disengage by placing the A/P ON/OFF switch to the "OFF" position.

b. IN-FLIGHT

- (1) Trim airplane (ball centered).
- (2) Check air pressure or vacuum to ascertain that the Directional Gyro and Attitude Gyro are receiving sufficient air.
- (3) Roll Section
 - (a) To engage, center Roll Command Knob, place the A/P ON/OFF switch to the "ON" position. To turn rotate roll command knob in desired direction. (Maximum angle of bank should not exceed 30°.)
 - (b) For heading mode, set Directional Gyro with Magnetic Compass. Push directional gyro HDG knob in, rotate to aircraft heading. Place the console HDG ON/OFF switch to the "ON" position. To select a new aircraft heading, push D.G. heading knob IN and rotate, in desired direction of turn, to the desired heading

NOTE

In HDG mode the maximum bank angles are limited to approximately 20° and single command, heading changes should be limited to 150°. (HDG Indice not more than 150° from actual aircraft heading.)

(4) VOR

(a) To Intercept:

1. Using OMNI Bearing Selector, dial desired course, inbound or outbound.
2. Set identical heading on Course Selector D.G.
3. After aircraft has stabilized, position coupler mode selector knob to OMNI mode. As aircraft nears selected radial, interception and crosswind correction will be automatically accomplished without further switching.

NOTE

If aircraft position is less than 45° from selected radial, aircraft will intercept before station. If position is more than 45°, interception will occur after station passage. As the aircraft nears the OMNI station, (1/2 mile) the zone of confusion will direct an "S" turn in alternate directions as the OMNI indicator needle swings. This alternate banking limited to the standard D.G. bank angle, is an indication of station passage.

(b) To select new course:

1. To select a new course or radial, rotate the HDG indice to the desired HDG (match course).
2. Rotate OBS to the new course. Aircraft will automatically turn to the intercept heading for the new course.

(c) To change stations:

1. If same course is desired, merely tune receiver to new station frequency.
2. If different course is desired, position coupler mode selector to HDG mode. Dial course selector D.G. to new course. Dial OBS to new course and position coupler mode selector to OMNI mode.

(5) VOR Approach

Track inbound to station as described in VOR navigation section.

After station passage:

- (a) Dial outbound course on Course Selector D.G., then dial same course on OBS.
- (b) After established on outbound radial, position coupler mode selector to HDG mode and select outbound procedure turn heading. After 40 seconds to 1 minute select a turn in the desired direction with the Course Selector D.G. to the inbound procedure turn heading.
- (c) Set OBS to inbound course.
- (d) When aircraft heading is 45° to the inbound course, dial Course Selector D.G. to inbound course and position coupler mode selector to OMNI mode.

NOTE

For precise tracking over OMNI station, without "S" turn, position coupler mode selector to HDG mode just prior to station passage. If holding pattern is desired, position coupler mode selector to HDG mode at station passage inbound and select outbound heading in direction of turn. After elapsed time, dial inbound course on Course Selector D.G. When aircraft heading is 45° to radial, position coupler mode selector to OMNI mode.

(6) LOC Approach Only

- (a) To intercept dial ILS outbound course on Course Selector D.G. When stabilized, position coupler mode selector to LOC REV mode.
- (b) After interception and when beyond outer marker, position coupler mode selector to HDG mode and dial outbound procedure turn heading. After one minute, dial inbound procedure turn heading in direction of turn.
- (c) When aircraft heading is 45° to ILS inbound course dial inbound course on Course Selector D.G. and position coupler mode selector to LOC NORM mode.
- (d) At the missed approach point (M.A.P.), or when missed approach is elected, position coupler mode selector to HDG mode and execute missed approach procedure.

(7) LOC Approach - Back Course (Reverse)

- (a) To intercept dial ILS Back Course outbound heading on Course Selector D.G. When stabilized, position coupler mode selector to LOC NORM mode.
- (b) After interception and when beyond fix, position coupler mode selector to HDG and dial outbound procedure turn heading. After one minute, dial inbound procedure turn heading in direction of turn.
- (c) When heading 45° to inbound course, dial inbound course on Course Selector D.G. and position coupler mode selector to LOC REV mode.
- (d) Approximately 1/2 mile from runway, position coupler mode selector to HDG mode to prevent "S" turn over ILS station near runway threshold.
- (e) Missed approach - same as Front Course. (See (6) d)

c. EMERGENCY OPERATION

- (1) In an emergency the AutoControl can be disconnected by:
 - (a) Placing the A/P ON/OFF switch to the "OFF" position.
 - (b) Pulling the Autopilot circuit breaker (aircraft S/N 28-7625001 through 28-7625275).
- (2) The AutoControl can be overpowered at either control wheel.
- (3) An Autopilot runaway, with a 3 second delay in the initiation of recovery, while operating in a climb, cruise or descending flight could result in a 60° bank and 100 foot altitude loss.
- (4) An Autopilot runaway, with a 1 second delay in the initiation of recovery, during an approach operation, coupled or uncoupled, could result in a 10° bank and 10 foot altitude loss.

3. PERFORMANCE

No change.

EMERGENCY PROCEDURES

Introduction	4-1
Engine Power Loss During Takeoff	4-1
Engine Power Loss In Flight	4-2
Power Off Landing	4-2
Spins	4-3
Open Door	4-3
Fire	4-4
Loss of Oil Pressure	4-5
Loss of Fuel Pressure	4-5
High Oil Temperature	4-5
Alternator Failure	4-6
Engine Roughness	4-6

BLANK PAGE

EMERGENCY PROCEDURES

INTRODUCTION

This section contains procedures that are recommended if an emergency condition should occur during ground operation, takeoff, or in flight. These procedures are suggested as the best course of action for coping with the particular condition described, but are not a substitute for sound judgment and common sense. Since emergencies rarely happen in modern aircraft, their occurrence is usually unexpected, and the best corrective action may not always be obvious. Pilots should familiarize themselves with the procedures given in this section and be prepared to take appropriate action should an emergency arise.

Most basic emergency procedures, such as power off landings, are a normal part of pilot training. Although these emergencies are discussed here, this information is not intended to replace such training, but only to provide a source of reference and review, and to provide information on procedures which are not the same for all aircraft. It is suggested that the pilot review standard emergency procedures periodically to remain proficient in them.

ENGINE POWER LOSS DURING TAKEOFF

The proper action to be taken if loss of power occurs during takeoff will depend on circumstances.

1. If sufficient runway remains for a normal landing, land straight ahead.
2. If insufficient runway remains, maintain a safe airspeed and make only a shallow turn if necessary to avoid obstructions. Use of flaps depends on circumstances. Normally, flaps should be fully extended for touchdown.
3. If you have gained sufficient altitude to attempt a restart, proceed as follows:
 - a. MAINTAIN SAFE AIRSPEED
 - b. FUEL SELECTOR - SWITCH TO ANOTHER TANK CONTAINING FUEL
 - c. ELECTRIC FUEL PUMP - CHECK ON
 - d. MIXTURE - CHECK RICH
 - e. CARBURETOR HEAT - ON

NOTE

If engine failure was caused by fuel exhaustion, power will not be regained after tanks are switched until empty fuel lines are filled, which may require up to ten seconds.

If power is not regained, proceed with the POWER OFF LANDING procedure.

ENGINE POWER LOSS IN FLIGHT

Complete engine power loss is usually caused by fuel flow interruption, and power will be restored shortly after fuel flow is restored. If power loss occurs at low altitude, the first step is to prepare for an emergency landing (See POWER OFF LANDING). Maintain an airspeed of at least 80 MPH IAS, and if altitude permits, proceed as follows:

1. Fuel Selector - Switch to another tank containing fuel.
2. Electric Fuel Pump - On
3. Mixture - Rich
4. Carburetor Heat - On
5. Engine Gauges - Check for indication of the cause of power loss.
6. Primer - Check Locked
7. If no fuel pressure is indicated, check tank selector position to be sure it is on a tank containing fuel.

When power is restored:

8. Carburetor Heat - Off
9. Electric Fuel Pump - Off

If the above steps do not restore power, prepare for an emergency landing.

If time permits:

1. Ignition Switch - "L" then "R" then back to "BOTH."
2. Throttle and Mixture - Different settings. (This may restore power if the problem is too rich or too lean a mixture, or if there is partial fuel system restriction.)
3. Try other fuel tanks. (Water in the fuel could take some time to be used up, and allowing the engine to windmill may restore power. If power loss is due to water, fuel pressure indications will be normal.)

NOTE

If engine failure was caused by fuel exhaustion, power will not be restored after tanks are switched until empty fuel lines are filled, which may require up to ten seconds.

If power is not restored, proceed with POWER OFF LANDING procedure.

POWER OFF LANDING

If loss of power occurs at altitude, trim the aircraft for best gliding angle (80 MPH IAS - Air Cond. OFF) and look for a suitable field. If measures taken to restore power are not effective, and if time permits, check your charts for airports in the immediate vicinity; it may be possible to land at one if you have sufficient altitude. If possible, notify the FAA by radio of your difficulty and intentions. If another pilot or passenger is aboard, let them help.

When you have located a suitable field, establish a spiral pattern around this field. Try to be at 1000 feet above the field at the downwind position to make a normal approach. Excess altitude may be lost by widening your pattern, using flaps or slipping, or a combination of these.

Touchdowns should normally be made at the lowest possible airspeed, with full flaps.

When committed to landing:

1. Ignition - Off
2. Master Switch - Off
3. Fuel Selector - Off
4. Mixture - Idle Cut-Off
5. Seat Belt (and harness if available) - Tight

SPINS

Intentional spins are prohibited in the normal category airplane and the utility category airplane when air conditioning is installed. For approved maneuvers as a utility category airplane, refer to the Flight Manual. If a spin is inadvertently entered, immediately use the following recovery procedures:

1. THROTTLE - IDLE
2. RUDDER - FULL OPPOSITE TO DIRECTION OF ROTATION
3. CONTROL WHEEL - FULL FORWARD
4. RUDDER - NEUTRAL (WHEN ROTATION STOPS)
5. CONTROL WHEEL - AS REQUIRED TO SMOOTHLY REGAIN LEVEL FLIGHT ATTITUDE

OPEN DOOR

The cabin door on the Cherokee is double latched, so the chances of its springing open in flight at both the top and bottom are remote. However, should you forget the upper latch, or not fully engage the lower latch, the door may spring partially open. This will usually happen at takeoff or soon afterward. A partially open door will not affect normal flight characteristics, and a normal landing can be made with the door open.

If both upper and lower latches are open, the door will trail slightly open, and airspeed will be reduced slightly.

To close the door in flight, proceed as follows:

1. Slow aircraft to 100 MPH IAS.
2. Cabin Vents - Close
3. Storm Window - Open
4. If upper latch is open - latch. If lower latch is open - open top latch, push door further open, and then close rapidly. Latch top latch.

A slip in the direction of the open door will assist in latching procedure.

FIRE

The presence of fire is noted through smoke, smell, and heat in the cabin. It is essential that the source of the fire be promptly identified through instrument readings, character of the smoke, or other indications, since the action to be taken differs somewhat in each case.

SOURCE OF FIRE - CHECK

1. Electrical Fire (Smoke in Cabin):
 - a. Master Switch - Off
 - b. Vents - Open
 - c. Cabin Heat - Off
 - d. Land as soon as possible.

2. Engine Fire (In Flight):
 - a. Fuel Selector - Off
 - b. Throttle - Closed
 - c. Mixture - Idle Cut-Off
 - d. Heater - Off (In all cases of fire)
 - e. Defroster - Off (In all cases of fire)
 - f. If terrain permits, land immediately.

NOTE

The possibility of an engine fire in flight is extremely remote. The procedure given above is general and pilot judgment should be the deciding factor for action in such an emergency.

3. Engine Fire (During Start):

Engine fires during start are usually the result of overpriming. The following procedure is designed to draw the excess fuel back into the induction system.

 - a. If engine has not started:
 - (1) Mixture - Idle Cut-Off
 - (2) Throttle - Open
 - (3) Turn engine with starter (This is an attempt to pull the fire into the engine.)
 - b. If engine has already started and is running, continue operating to try pulling the fire into the engine.
 - c. In either case stated in (a) and (b), if the fire continues longer than a few seconds, the fire should be extinguished by the best available external means.
 - d. If external fire extinguishing is to be applied:
 - (1) Fuel Selector Valves - Off
 - (2) Mixture - Idle Cut-Off

LOSS OF OIL PRESSURE

Loss of oil pressure may be either partial or complete. A partial loss of oil pressure usually indicates a malfunction in the oil pressure regulating system, and a landing should be made as soon as possible to investigate the cause and prevent engine damage.

A complete loss of oil pressure indication may signify oil exhaustion or may be the result of a faulty gauge. In either case, proceed toward the nearest airport, and be prepared for a forced landing. If the problem is not a pressure gauge malfunction, the engine may stop suddenly. Maintain altitude until such time as a dead stick landing can be accomplished. Don't change power settings unnecessarily, as this may hasten complete power loss.

Depending on the circumstances, it may be advisable to make an off airport landing while power is still available, particularly if other indications of actual oil pressure loss, such as sudden increases in temperatures, or oil smoke, are apparent, and an airport is not close.

If engine stoppage occurs, proceed to POWER OFF LANDING.

LOSS OF FUEL PRESSURE

1. Electric Boost Pump - On
2. Fuel Selector - Check on full tank

If problem is not an empty fuel tank, land as soon as practical and have engine-driven fuel pump checked.

HIGH OIL TEMPERATURE

An abnormally high oil temperature indication may be caused by a low oil level, an obstruction in the oil cooler, damaged or improper baffle seals, a defective gauge, or other causes. Land as soon as practical at an appropriate airport and have the cause investigated.

A steady, rapid rise in oil temperature is a sign of trouble. Land at the nearest airport and let a mechanic investigate the problem. Watch the oil pressure gauge for an accompanying loss of pressure.

ALTERNATOR FAILURE

Loss of alternator output is detected through a zero reading on the ammeter. Before executing the following procedure, insure that the reading is zero and not merely low by actuating an electrically powered device, such as the landing light. If no increase in the ammeter reading is noted, alternator failure can be assumed.

1. Reduce Electrical Load.
2. Alternator Circuit Breakers - Check
3. "Alt" Switch - Off (for 1 second), then On

If the ammeter continues to indicate no output, or alternator will not stay reset, turn off "Alt" switch, maintain minimum electrical load and land as soon as practical. All electrical load is being supplied by the battery.

ENGINE ROUGHNESS

Engine roughness is usually due to carburetor icing which is indicated by a drop in RPM, and may be accompanied by a slight loss of airspeed or altitude. If too much ice is allowed to accumulate, restoration of full power may not be possible; therefore, prompt action is required.

Turn carburetor heat on (See Note). RPM will decrease slightly and roughness will increase. Wait for a decrease in engine roughness or an increase in RPM, indicating ice removal. If no change in approximately one minute, return the carburetor heat to COLD. If the engine is still rough, try steps below:

1. Mixture - Adjust for maximum smoothness. Engine will run rough if too rich or too lean.
2. Electric Fuel Pump - On
3. Fuel Selector - Change tanks to see if fuel contamination is the problem.
4. Engine Gauges - Check for abnormal readings. If any gauge readings are abnormal, proceed accordingly.
5. Magneto Switch - "L" then "R", then back to "BOTH." If operation is satisfactory on either magneto, proceed on that magneto at reduced power, with mixture full rich, to a landing at the first available airport.

If roughness persists, prepare for a precautionary landing at pilot's discretion.

NOTE



Partial carburetor heat may be worse than no heat at all, since it may partially melt ice, which will refreeze in the intake system. When using carburetor heat, therefore, always use full heat, and when ice is removed return the control to the full cold position.

INDEX - WEIGHT AND BALANCE

Log of Revisions	5-iii
Weight and Balance	5-1
Weight and Balance Data - Weighing Procedure	5-3
Weight and Balance	5-7
C. G. Range and Weight Instructions	5-8
Sample Loading Problem	5-9
Maximum Allowable Baggage	5-11
Equipment List	5-15
A. Propeller and Propeller Accessories	5-15
B. Engine and Engine Accessories	5-16
C. Landing Gear and Brakes	5-17
D. Electrical Equipment	5-18
E. Instruments	5-19
F. Miscellaneous	5-20
G. Engine and Engine Accessories (Optional Equipment)	5-21
H. Electrical Equipment (Optional Equipment)	5-22
I. Instruments (Optional Equipment)	5-24
J. Autopilots (Optional Equipment)	5-25
K. Radio Equipment (Optional Equipment)	5-26
L. Miscellaneous (Optional Equipment)	5-29

THIS PAGE INTENTIONALLY LEFT BLANK

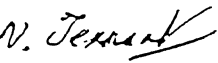
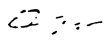
WEIGHT AND BALANCE LOG OF REVISIONS

Revision	Revised Pages	Description and Revision	Approved Date
1	5-16 5-18 5-20 5-22 5-27 5-28 5-29 5-30	Revised Oil Cooler Weight and Moment. Revised Voltage Regulator Weight and Moment; Revised Battery Weight and Moment. Revised Baggage Tie Down Straps Weight and Moment; Revised Toe Brakes Weight and Moment and added dwg. no. Revised Battery Weight and Moment. Revised Narco Audio Panel Weight, Arm and Moment; Revised MBT-12-R Marker Beacon Weight, Arm and Moment. Revised -10, -12 Microphone Weights, Arms and Moments. Revised Nose Wheel Fairing and Main Wheel Fairing Weights, Arms and Moments; Changed Jump Seat to -4 Install.; Revised Ash Trays Weight and Moment. Removed Baggage Tie Down Straps; Revised Right and Left Vert, Adj. Front Seat Weights, Arms and Moments; Revised Ground Vent. Blower; Added Corrosive Resistant Kit	October 22, 1973 
2	Title	Added PAC Approval Form. (NOTE: AIRCRAFT DELIVERED WITH MANUALS PRIOR TO THIS REVISION DO NOT REQUIRE THIS REVISION.)	May 29, 1974 
3	5-16 5-18 5-20 5-21 5-23 5-24 5-25	Added Oil Filters and footnote. Added Annunciator Lights and footnote. Revised Inertia Safety Belts weights, moment and part no. Added Airborne Vacuum Pump (PAC 79399-0); added Low Vacuum Annunciator Light; added Airborne Vacuum Regulator (*2H3-19); added footnotes. Added Overhead Red Panel Lights and Instrument Panel Lights. Added Encoding Altimeter and footnote. Added Autocontrol IIIB and footnotes; revised nomenclature (Console #1C338).	June 13, 1974 

WEIGHT AND BALANCE LOG OF REVISIONS (cont)

Revision	Revised Pages	Description and Revision	Approved Date
3 (cont)	5-26 5-27 5-28 5-28a, 5-28b, 5-28c, 5-28d 5-29	Revised nomenclature (King KX175); added footnote. Added footnote. Revised nomenclature (King KMA-20 Audio Panel). Added pages (info for ser. nos. 7525001 and up). Revised Inertia Safety Belts part no.; revised Assist Strap and Coat Hook dwg. no., added Assist Strap.	
4	5-14 5-21 5-28a	Revised Utility Category Aft C.G. Limit. Revised Airborne Vacuum Pump Moment. Revised King Dual KNI-520 Weight.	Nov. 1, 1974 <i>CRinkh.</i>
5	5-5 5-30	Revised equations. Added two Overhead Vent Systems.	Jan. 21, 1975 <i>CRinkh.</i>
6	5-14 5-16 5-22 5-24 5-30 5-31	Revised C.G. Range and Weight graph. Deleted Chrysler Alternator. Revised Dwg. No. (Piper Pitch Trim) to -2; added -3; added footnote. Added Engine Hour Meter and footnote. Added 79590-0 left Front Seat; added 79590-1 right Front Seat; added 79337-18 Headrest. Added Stainless Steel Control Cables.	May 16, 1975 <i>CRinkh.</i>
7	5-22	Revised Rotating Beacon desc.	July 18, 1975 <i>CRinkh.</i>
8	5-24 5-28 5-28a	Revised Clock. Revised Automatic Locator Transmitter. Added KN61 and KN65A DME's.	Nov. 27, 1975 <i>CRinkh.</i>
9	5-28	Added Automatic Locator Transmitter.	July 19, 1976 <i>CRinkh.</i>

WEIGHT AND BALANCE LOG OF REVISIONS (cont)

Revision	Revised Pages	Description and Revision	Approved Date
10	Title	Added Applicable Serial Numbers. (NOTE: AIRCRAFT DELIVERED WITH MANUALS PRIOR TO THIS REVISION DO NOT REQUIRE THIS REVISION.)	Sept. 30, 1977 <i>C.F. Ruhl</i>
11	5-1 5-3 5-4	Revised Weight and Balance info. Added Caution; relocated para. 2.b. to pg. 5-4 Added para. 2.b. from pg. 5-3.	April 16, 1979 <i>Hal Fletcher</i>
12	5-1	Revised Weight and Balance info.	May 22, 1980 <i>Hal Fletcher</i>
13	5-1 5-3, 5-7 5-15 5-16 5-18, 5-21, 5-22 5-24 5-25 5-26 5-28a, 5-28b 5-28c	Revised Weight and Balance info. Revised Weight and Balance Data info. Revised Equipment List. Added Niagara N.D.M 20002A to existing oil cooler description: added ending serial effectivity. Added ending serial number effectivity. Revised Encoding Altimeter Moment: added ending serial number effectivity. Added ending serial number effectivity. Revised King KI 214 () VOR/LOC/GS Ind. Moment. Added ending serial number effectivity. Revised Sense Antenna and Cable #1 Moment; added ending serial number effectivity.	July 13, 1984 <i>Ward Evans</i>

THIS PAGE INTENTIONALLY LEFT BLANK

WEIGHT AND BALANCE

In order to achieve the performance and flying characteristics which are designed into the airplane, it must be flown with the weight and center of gravity (C.G.) position within the approved operating range (envelope). Although the airplane offers flexibility of loading, it cannot be flown with the maximum number of adult passengers, full fuel tanks and maximum baggage. With the flexibility comes responsibility. The pilot must ensure that the airplane is loaded within the loading envelope before he makes a takeoff.

Misloading carries consequences for any aircraft. An overloaded airplane will not take off, climb or cruise as well as a properly loaded one. The heavier the airplane is loaded, the less climb performance it will have.

Center of gravity is a determining factor in flight characteristics. If the C.G. is too far forward in any airplane, it may be difficult to rotate for takeoff or landing. If the C.G. is too far aft the airplane may rotate prematurely on takeoff or tend to pitch up during climb. Longitudinal stability will be reduced. This can lead to inadvertent stalls and even spins, and spin recovery becomes more difficult as the center of gravity moves aft of the approved limit.

A properly loaded airplane, however, will perform as intended. Before the airplane is licensed, it is weighed, and a licensed empty weight and C.G. location is computed (licensed empty weight consists of the standard empty weight of the airplane plus the optional equipment). Using the licensed empty weight and C.G. location the pilot can determine the weight and C.G. position for the loaded airplane by computing the total weight and moment and then determining whether they are within the approved envelope.

The licensed empty weight and C.G. location are recorded in the Weight and Balance Data Form (Page 5-7). The current values should always be used. Whenever new equipment is added or any modification work is done, the mechanic responsible for the work is required to compute a new licensed empty weight and C.G. position and to write these in the Aircraft Log Book and the Weight and Balance Data Form. The owner should make sure that it is done.

A weight and balance calculation is necessary in determining how much fuel or baggage can be boarded so as to keep within allowable limits. Check calculations prior to adding fuel to insure against improper loading.

The following pages are forms used in weighing an airplane in production and in computing licensed empty weight, C.G. position, and useful load. Note that the useful load includes usable fuel, baggage, cargo and passengers. Following this is the method for computing takeoff weight and C.G.

THIS PAGE INTENTIONALLY LEFT BLANK

WEIGHT AND BALANCE DATA

WEIGHING PROCEDURE

At the time of licensing Piper Aircraft Corporation provides each airplane with the licensed empty weight and center of gravity location. This data is on Page 5-7.

The removal or addition of equipment or airplane modifications can affect the licensed empty weight and empty weight center of gravity. The following is a weighing procedure to determine licensed empty weight and center of gravity location:

1. PREPARATION

- a. Be certain that all items checked in the airplane equipment list are installed in the proper location in the airplane.
- b. Remove excessive dirt grease moisture foreign items such as rags and tools from the airplane before weighing.
- c. Defuel airplane. Then open all fuel drains until all remaining fuel is drained. Operate engine on each tank until all undrainable fuel is used and engine stops.

CAUTION

Whenever the fuel system is completely drained and fuel is replenished it will be necessary to run the engine for a minimum of 3 minutes at 1000 RPM on each tank to insure no air exists in the fuel supply lines.

- d. Drain all oil from the engine by means of the oil drain, with the airplane in ground attitude. This will leave the undrainable oil still in the system. Engine oil temperature should be in the normal operating range before draining.
- e. Place pilot and copilot seats in fourth (4th) notch, aft of forward position. Put flaps in the fully retracted position and all control surfaces in the neutral position. Tow bar should be in the proper location and all entrance and baggage doors closed.
- f. Weigh the airplane inside a closed building to prevent errors in scale readings due to wind.

2. LEVELING

- a. With airplane on scales, block main gear oleo pistons in the fully extended position.

CHEROKEE CRUISER

- b. Level airplane (see diagram) by deflating nose wheel tire, to center bubble on level.

3. WEIGHING - AIRPLANE EMPTY WEIGHT

- a. With the airplane level and brakes released, record the weight shown on each scale. Deduct the tare, if any, from each reading

Scale Position and Symbol	Scale Reading	Tare	Net Weight
Nose Wheel (N)			
Right Main Wheel (R)			
Left Main Wheel (L)			
Airplane Empty Weight, as Weighed (T)			

4. EMPTY WEIGHT CENTER OF GRAVITY

- a. The following geometry applies to the PA-28-140 airplane when airplane is level (See Item 2).

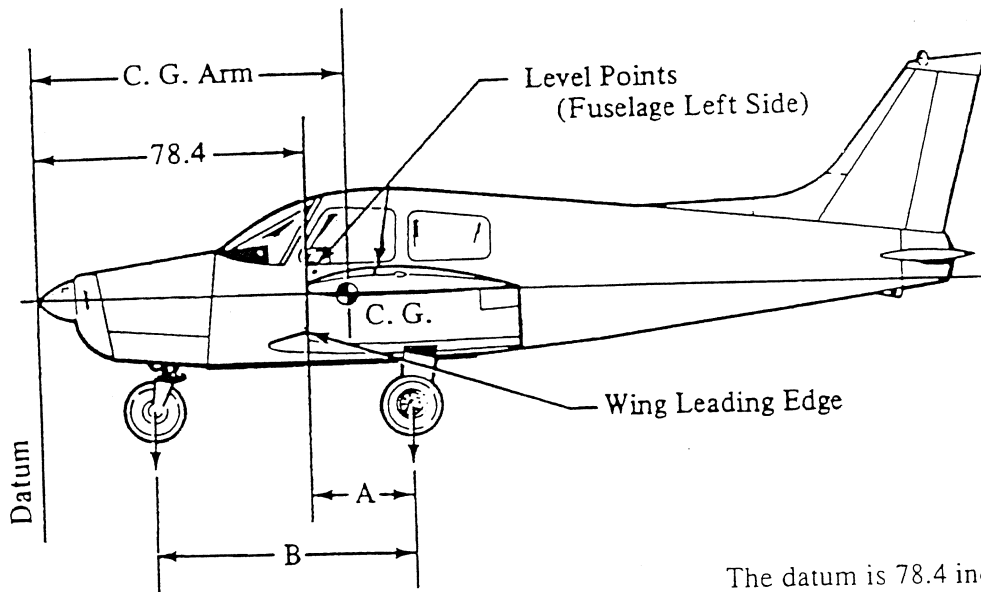

The datum is 78.4 inches ahead of the wing leading edge at the intersection of the straight and tapered section.

A =

B =

- b. Obtain measurement "A" by measuring from a plumb bob dropped from the wing leading edge, at the intersection of the straight and tapered section, horizontally and parallel to the airplane centerline, to the main wheel centerline.
- c. Obtain measurement "B" by measuring the distance from the main wheel centerline, horizontally and parallel to the airplane centerline, to each side of the nose wheel axle. Then average the measurements.
- d. The empty weight center of gravity (as weighed including optional equipment and undrainable oil) can be determined by the following formula:

$$\text{C.G. Arm} = 78.4 + A - \frac{B(N)}{T}$$

$$\text{C. G. Arm} = 78.4 + (\quad) - \frac{(\quad)(\quad)}{(\quad)} = \quad \text{inches}$$

5. LICENSED EMPTY WEIGHT AND EMPTY WEIGHT CENTER OF GRAVITY

	Weight	Arm	Moment
Empty Weight (as weighed)			
Unusable Fuel (3 pints)	+ 2.2	103.0	+ 227
Licensed Empty Weight			

THIS PAGE INTENTIONALLY LEFT BLANK

WEIGHT AND BALANCE DATA

MODEL PA-28-140 CHEROKEE

Airplane Serial Number 28 - 7425363

Registration Number C-GODP

Date 5-9-74

THE WEIGHT AND BALANCE DATA SHOWN IN THIS REPORT ARE COMPUTED ON THE BASIS OF FEDERAL AVIATION ADMINISTRATION APPROVED PROCEDURES FOR ESTABLISHING FLEET WEIGHT AVERAGES.

AIRPLANE EMPTY WEIGHT

Item	Weight (Lbs)	×	C. G. Arm (Inches Aft of Datum)	= Moment (In-Lbs)
*Empty Weight XXXXX Computed	1273.0		85.2	108417
Unusable Fuel (3 pints)	2.2		103.0	227
Standard Empty Weight	1275.2		85.2	108644
Optional Equipment	90.5		86.4	7820
Licensed Empty Weight	1365.7		85.1	116237

*Empty weight is defined as dry empty weight (including paint and hydraulic fluid) plus 1.8 lbs undrainable engine oil.

SUPERSEDED

AIRPLANE USEFUL LOAD

(Gross Weight) - (Licensed Empty Weight) = Useful Load

Normal Category: (2150 lbs) - (1365.7 lbs) = 784.3 lbs

Utility Category: (1950 lbs) - (1365.7 lbs) = 584.3 lbs

THIS LICENSED EMPTY WEIGHT, C. G. AND USEFUL LOAD ARE FOR THE AIRPLANE AS DELIVERED FROM THE FACTORY. REFER TO APPROPRIATE AIRCRAFT RECORD WHEN ALTERATIONS HAVE BEEN MADE.

WEIGHT AND BALANCE DATA

MODEL PA-28-140 CHEROKEE

Airplane Serial Number 28 -

Registration Number

Date

AIRPLANE EMPTY WEIGHT

Item		Weight (Lbs)	X	C. G. Arm (Inches Aft of Datum)	=	Moment (In-Lbs)
*Empty Weight	Actual Computed					
Unusable Fuel (3 pints)		2.2		103.0		227
Standard Empty Weight						
Optional Equipment						
Licensed Empty Weight						

*Empty weight is defined as dry empty weight (including paint and hydraulic fluid) plus 1.8 lbs undrainable engine oil.

AIRPLANE USEFUL LOAD

(Gross Weight) - (Licensed Empty Weight) = Useful Load

Normal Category: (2150 lbs) - (lbs) = lbs

Utility Category: (1950 lbs) - (lbs) = lbs

THIS LICENSED EMPTY WEIGHT, C.G. AND USEFUL LOAD ARE FOR THE AIRPLANE AS LICENSED AT THE FACTORY. REFER TO APPROPRIATE AIRCRAFT RECORD WHEN ALTERATIONS HAVE BEEN MADE.

C. G. RANGE AND WEIGHT INSTRUCTIONS

1. Add the weight of all items to be loaded to the licensed empty weight.
2. Use the loading graph to determine the moment of all items to be carried in the airplane.
3. Add the moment of all items to be loaded to the licensed empty weight moment.
4. Divide the total moment by the total weight to determine the C.G. location.
5. By using the figures of Item 1 and Item 4, locate a point on the C.G. range and weight graph. If the point falls within the C.G. envelope, the loading meets the weight and balance requirements.

NOTE

With optional jump seats installed, aft passenger weight is restricted only by airplane weight and balance limitations (See Page 5-14). For baggage allowance, see Page 5-11.

SAMPLE LOADING PROBLEM (Normal Category)

	Weight (Lbs)	Arm Aft Datum (Inches)	Moment (In-Lbs)
Licensed Empty Weight			
Oil (8 quarts)	15	32.5	488
Pilot and Front Passenger	340	85.5	29070
Passengers, Aft *		117.0	
Fuel (50 Gal. Maximum)		95.0	
Baggage * Area 1		117.0	
Baggage * Area 2		133.3	
Total Loaded Airplane			

The center of gravity (C.G.) of this sample loading problem is at _____ inches aft of the datum line. Locate this point (_____) on the C.G. range and weight graph. Since this point falls within the weight - C.G. envelope, this loading meets the weight and balance requirements.

IT IS THE RESPONSIBILITY OF THE PILOT AND AIRCRAFT OWNER TO INSURE THAT THE AIRPLANE IS LOADED PROPERLY.

- *Utility Category Operation - No baggage or aft passengers allowed.
- Normal Category Operation - See Page 5-11.

THIS PAGE INTENTIONALLY LEFT BLANK

MAXIMUM ALLOWABLE BAGGAGE

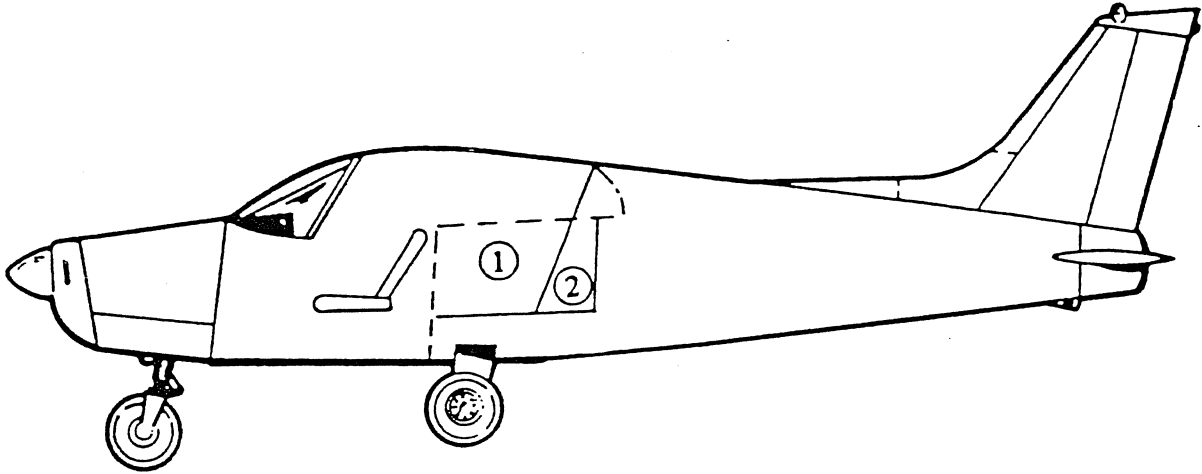

- A. Maximum Allowable Baggage Capacity Area ① = 200 lbs.
- B. Maximum Allowable Baggage Capacity Area ② = 100 lbs.

Aircraft are eligible for 100-lb maximum baggage in this area when modified in accordance with Piper drawing 66671.

THIS PAGE INTENTIONALLY LEFT BLANK

LOADING GRAPH

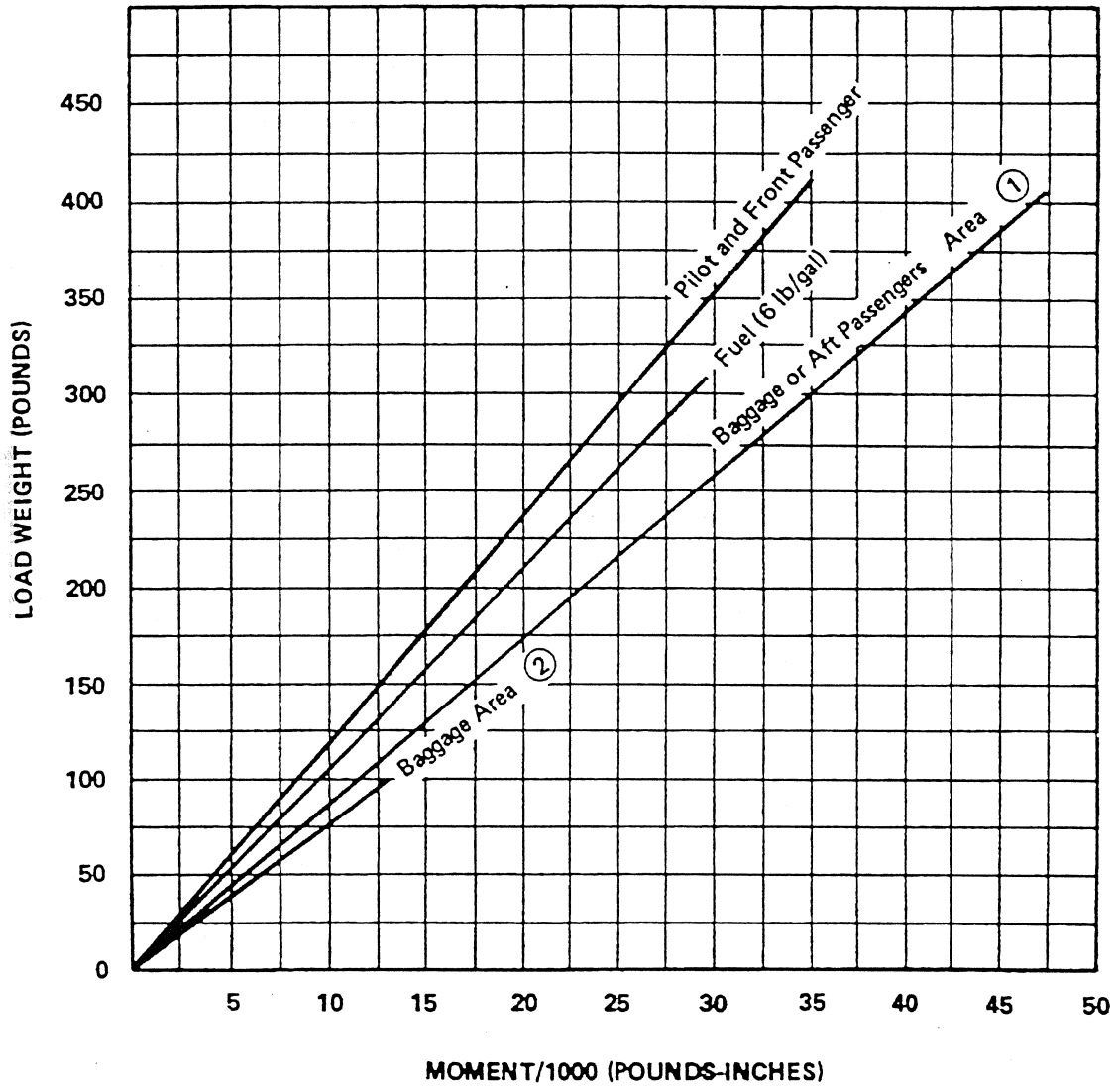

C. G. RANGE AND WEIGHTS

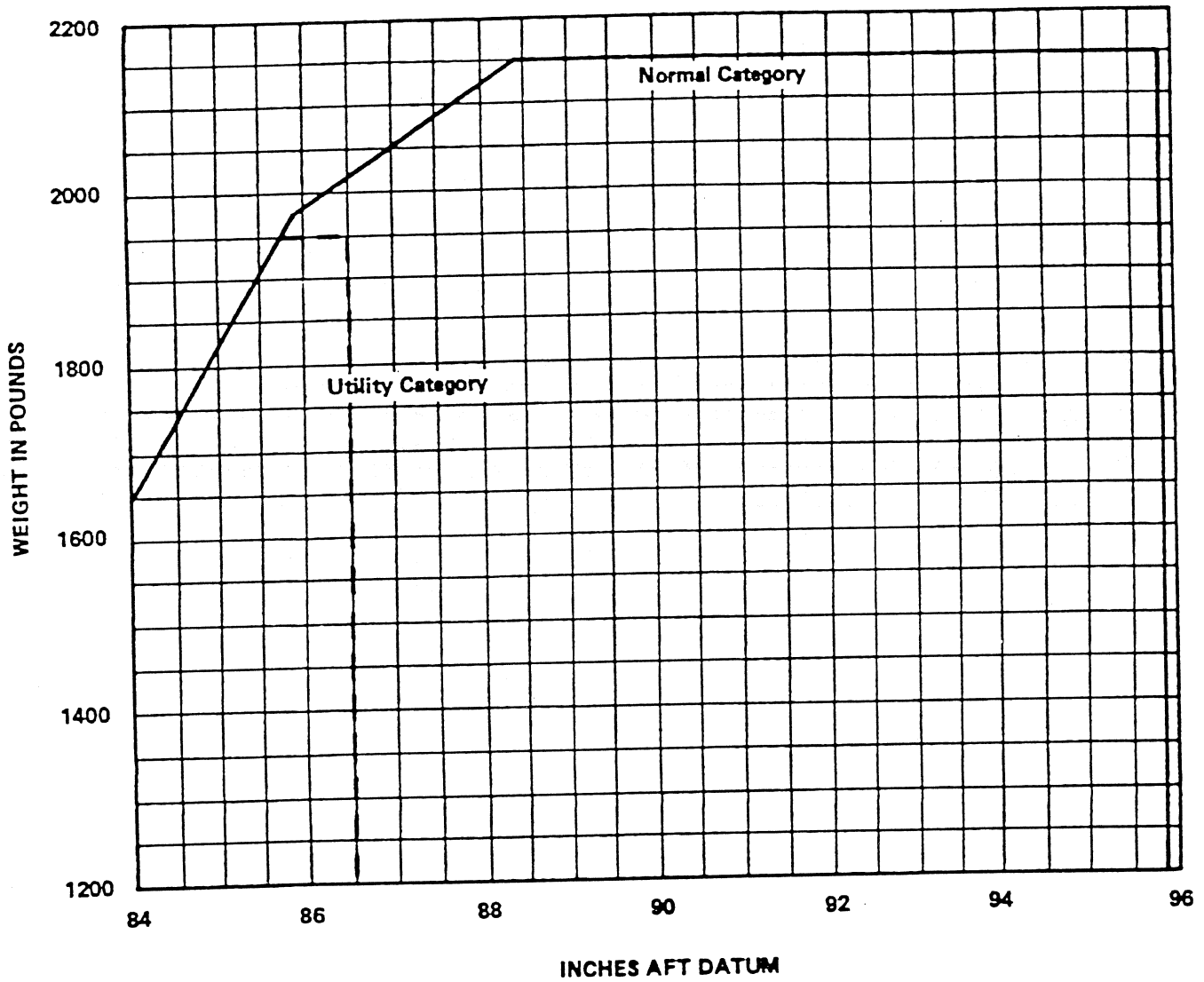

OPERATING INSTRUCTIONS

Preflight	7-1
Starting Engine	7-2
Starting Engine When Cold	7-2
Starting Engine When Hot	7-2
Starting Engine When Flooded	7-2
Starting Engine With External Power Source	7-3
Warm-Up	7-3
Ground Check	7-3
Takeoff	7-4
Climb	7-5
Stalls	7-5
Cruising	7-5
Turbulent Air Operation	7-6
Maneuvers	7-6
Approach and Landing	7-6
Stopping Engine	7-7
Airspeed Data	7-7
Mooring	7-8
Weight and Balance	7-8
Air Conditioning	7-8
Air Conditioner Operational Check Procedure	7-8
Air Conditioner Effects on Airplane Performance	7-9
Emergency Locator Transmitter	7-10

OPERATING INSTRUCTIONS

PREFLIGHT

The airplane should be given a thorough visual inspection prior to each flight. Particular attention should be given to the following items:

1.
 - a. Release seat belt securing control wheel.
 - b. Master switch ON.
 - c. Check fuel quantity indicators (two tanks).
 - d. Master switch and ignition OFF.
2.
 - a. Check for external damage, operation interference of control surfaces or hinges.
 - b. Insure that wings and control surfaces are free of snow, ice or frost.
3.
 - a. Visually check fuel supply, secure caps.
 - b. Drain all fuel system sumps and lines and check for water, sediment and proper fuel. (See Fuel System Section for procedure.)
 - c. Check that fuel system vents are open.
4.
 - a. Check landing gear shock struts for proper inflation (approximately 4-1, 2 inches).
 - b. Check tires for cuts, wear and proper inflation.
 - c. Check brake blocks and discs for wear and damage.

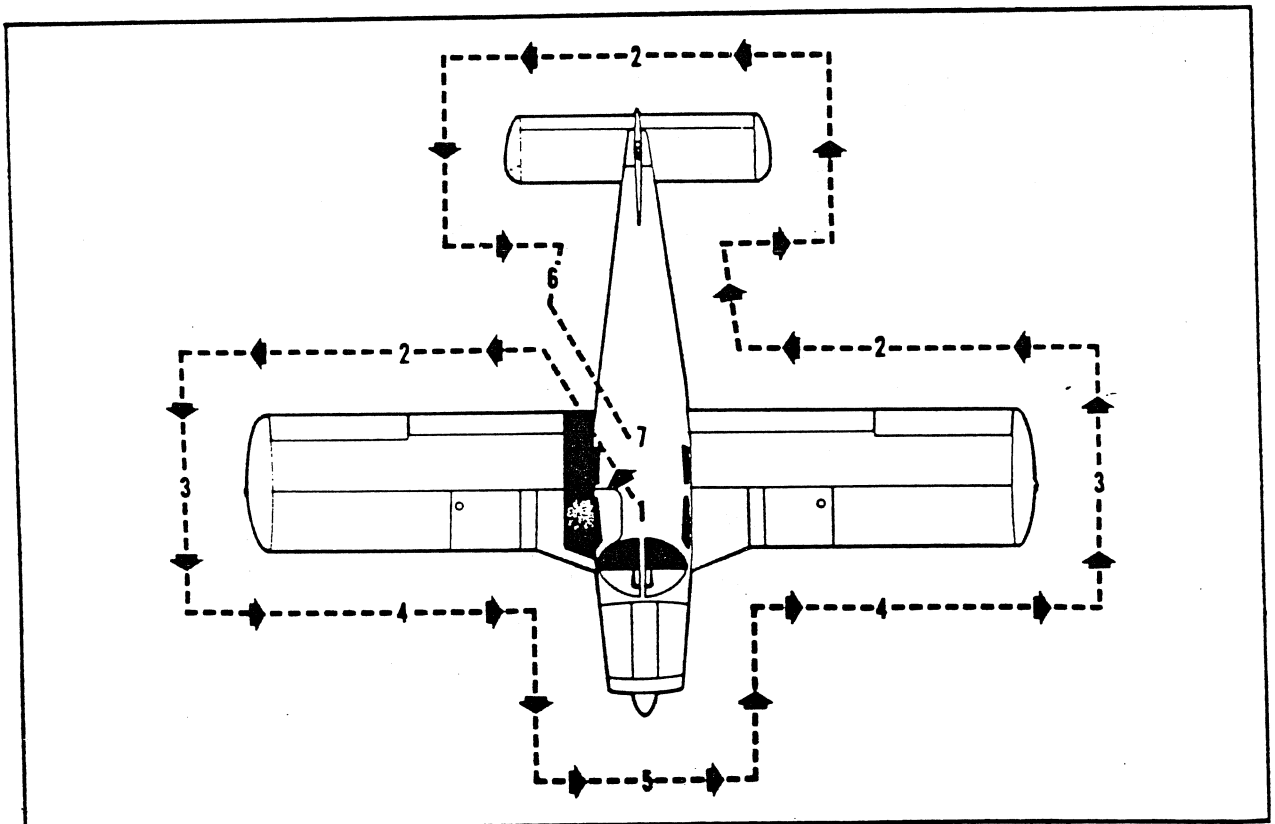

CHEROKEE CRUISER

5.
 - a. Inspect windshield for cleanliness.
 - b. Check the propeller and spinner for defects or nicks.
 - c. Check for obvious fuel or oil leaks.
 - d. Check oil level, 8 quarts maximum (Insure dipstick is properly seated.)
 - e. Inspect cowling and inspection covers for security.
 - f. Check nose wheel tire for inflation, wear.
 - g. Check nose wheel shock strut for proper inflation (approximately 3-1/4 inches).
 - h. Check for foreign matter in air inlets.
 - i. Check alternator belt tension.
6.
 - a. Stow tow bar and control locks, if used.
 - b. Check baggage for proper storage and security.
7.
 - a. Upon entering aircraft ascertain that all primary flight controls operate properly.
 - b. Close and secure the cabin door.
 - c. Check that required papers are in order and in the aircraft.
 - d. Fasten seat belts and shoulder harness. Check function of inertia reel.

STARTING ENGINE

1. Set parking brake ON.
2. Set the carburetor heat control in the full COLD (OFF) position.
3. Select the desired tank with fuel selector valve.

STARTING ENGINE WHEN COLD

1. Open throttle approximately 1/4 inch.
2. Turn the master switch ON.
3. Turn the electric fuel pump ON.
4. Move the mixture control to FULL RICH.
5. Engage the starter by rotating magneto switch clockwise and pressing in.
6. When the engine fires, advance throttle to desired setting. If the engine does not fire within five to ten seconds, disengage starter and prime with one to three strokes of the priming pump. Repeat starting procedure.

STARTING ENGINE WHEN HOT

1. Open the throttle approximately 1/2 inch.
2. Turn the master switch ON.
3. Turn the electric fuel pump ON.
4. Put mixture control in full RICH.
5. Engage the starter by rotating magneto switch clockwise and pressing in. When the engine fires move the throttle to desired setting.

STARTING ENGINE WHEN FLOODED

1. Open the throttle full.
2. Turn the master switch ON.
3. Turn the electric fuel pump OFF.

4. Put mixture control in IDLE CUT-OFF.
5. Engage the starter by rotating magneto switch clockwise and pressing in. When the engine fires, advance the mixture control and retard the throttle.

When the engine is firing evenly, advance the throttle to 800 RPM. If oil pressure is not indicated within thirty seconds, stop the engine and determine the trouble. In cold weather it will take a few seconds longer to get an oil pressure indication. If the engine has failed to start, refer to the "Lycoming Operating Handbook, Engine Troubles and Their Remedies."

Starter manufacturers recommend that cranking periods be limited to thirty seconds with a two minute rest between cranking periods. Longer cranking periods will shorten the life of the starter.

STARTING ENGINE WITH EXTERNAL POWER SOURCE*

An optional feature known as Piper External Power (PEP) allows the operator to use an external battery to crank the engine without having to gain access to the aircraft battery.

The procedure is as follows:

1. Turn aircraft MASTER SWITCH to OFF.
2. Connect RED lead of PEP kit jumper cable to POSITIVE (+) terminal of external 12-volt battery and BLACK lead to NEGATIVE (-) terminal.
3. Insert plug of jumper cable into socket located on aircraft fuselage.
4. Turn aircraft MASTER SWITCH to ON and proceed with NORMAL engine starting technique.
5. After engine has been started, turn MASTER SWITCH to OFF and remove jumper cable plug from aircraft.
6. Turn aircraft MASTER SWITCH to ON and check alternator ammeter for indication of output. DO NOT ATTEMPT FLIGHT IF THERE IS NO INDICATION OF ALTERNATOR OUTPUT.

WARM-UP

As soon as the engine starts, the oil pressure should be checked. If no pressure is indicated within thirty seconds, stop the engine and determine the trouble. In cold weather it will take a few seconds longer to get an oil pressure indication. Warm-up the engine at 800 to 1200 RPM.

Takeoff may be made as soon as the ground check is completed, providing that the throttle may be opened fully without backfiring, or skipping, and without a reduction in engine oil pressure.

GROUND CHECK

Check the magnetos at 2000 RPM by switching from Both to Right then back to Both before switching to Left. Differential drop should not exceed 50 RPM while the total drop on either magneto should not exceed 175 RPM.

Check vacuum gauge; indicator should read $5'' \pm .1''$ Hg at 2000 RPM.

* Optional equipment

CHEROKEE CRUISER

Check both the oil temperature and pressure. The temperature may be low for some time if the engine is being run for the first time of the day, but as long as the pressure is within limits, the engine is ready for takeoff.

Check the annunciator panel lights with the press-to-test button*.

Carburetor heat should also be checked prior to takeoff to be sure that the control is operating properly and to clear any ice which may have formed during taxiing. Avoid prolonged ground operation with carburetor heat ON as the air is unfiltered.

Operation of the engine driven fuel pump should be checked while taxiing or during preflight engine run up by switching off the electric fuel pump and observing fuel pressure. The electric fuel pump should be on during takeoff to prevent loss of power should the engine driven pump fail. The engine is warm enough for takeoff when the throttle can be opened without the engine faltering. For air conditioner ground check refer to page 7-8.

TAKEOFF

Just before takeoff the following items should be checked:

1. Fuel on proper tank
2. Electric fuel pump - on
3. Engine gauges - checked
4. Flaps - set
5. Carburetor heat - off
6. Mixture - set
7. Seat backs - erect
8. Safety Belts/harness - fastened
9. Empty seats- seat belts snugly fastened
10. Trim tab - set
11. Controls - free
12. Door - latched
13. Air conditioner - off

NOTE

Mixture full rich except a minimum amount of leaning is permitted for smooth engine operation when taking off at high elevation.

In the conventional takeoff procedure set the trim control slightly aft of neutral. Allow the airplane to accelerate to 50 to 60 miles per hour, then ease back on the wheel enough to let the airplane fly itself from the ground. Premature or excessive raising of the nose will result in a delayed takeoff. After takeoff let the aircraft accelerate to the desired climb speed by lowering the nose slightly.

Short Field, Obstacle Clearance:

Lower the flaps to 25° (second notch), accelerate to 55-60 miles per hour and ease back on the control wheel to rotate. After breaking ground, accelerate to the best angle of climb speed, 78 miles per hour. Slowly retract the flaps when the obstacle has been cleared, and continue climb at 89 miles per hour.

Short Field, No Obstacles:

Lower the flaps to 25° (second notch), accelerate to 55-60 miles per hour. Ease back on the control wheel to rotate and accelerate to best rate of climb speed, 89 miles per hour. Slowly retract the flaps while climbing out.

*Serial nos. 28-7525001 through 28-7625275

Soft Field, No Obstacle:

Lower the flaps to 25° (second notch), accelerate aircraft and pull nose gear from the ground as soon as possible, lift off at lowest possible airspeed. Accelerate just above the ground to best rate of climb speed, 89 miles per hour. Climb out while slowly retracting the flaps.

Soft Field, Obstacle Clearance:

Lower flaps to 25° (second notch), accelerate aircraft, pull nose gear off as soon as possible and lift off at lowest possible airspeed. Accelerate just above the ground to best angle of climb speed, 78 miles per hour to climb past obstacle clearance height; continue climb while accelerating to best rate of climb speed, 89 miles per hour, and slowly retract the flaps.

CLIMB

The best rate of climb airspeed at gross weight is 89 miles per hour. The best angle of climb airspeed is 78 miles per hour. At lighter than gross weight these speeds are reduced. The recommended en route climbing speed of 100 miles per hour provides increased visibility over the nose. Shallow turns of a few degrees will also aid forward visibility during climb out. The air conditioner may be turned on after all obstacles have been cleared.

STALLS

Stall characteristics of the Cherokee are conventional. Visual stall warning is provided by a red light located on the left side of the instrument panel which illuminates automatically between 5 and 10 miles per hour above stall speed. Gross weight stalling speed with power off and full flaps is 55 miles per hour at 2150 pounds. With flaps up this speed is increased 9 miles per hour. Loss of altitude during stalls can be as great as 200 feet, depending on configuration and power. Intentional spins are prohibited in the normal category airplane and when air conditioning or ventilation blower is installed.

CRUISING

The cruising speed is determined by many factors, including power setting, altitude, temperature, loading and equipment installed on the airplane.

The normal cruising power is 75% of the rated horsepower of the engine. True airspeeds, which may be obtained at various altitudes and power settings, can be determined from the charts in Performance Charts Section.

Use of the mixture control in cruising flight reduces fuel consumption significantly, especially at higher altitudes, and reduces lead deposits when the alternate fuels are used. The mixture should be leaned when 75% power or less is being used. If any doubt exists as to the amount of power being used, the mixture should be in the FULL RICH position for all operations. Always enrich the mixture before increasing power settings.

To lean the mixture, pull the mixture control until the engine becomes rough, indicating that the lean mixture limit has been reached in the leaner cylinders. Then enrich the mixture by pushing the control towards the instrument panel until engine operation becomes smooth.

CHEROKEE CRUISER

The continuous use of carburetor heat during cruising flight decreases engine efficiency. Unless icing conditions in the carburetor are severe, do not cruise with the heat on. Apply full carburetor heat slowly and only for a few seconds at intervals determined by icing severity.

In order to keep the airplane in best lateral trim during cruising flight, the fuel should be used alternately from each main tank. It is recommended that one main tank be used for one hour after takeoff, the other main tank used until nearly exhausted, then return to the first main tank.

TURBULENT AIR OPERATION

In keeping with good operating practice used in all aircraft, it is recommended that when turbulent air is encountered or expected the airspeed be reduced to maneuvering speed to reduce the structural loads caused by gusts and to allow for inadvertent speed build-ups which may occur as a result of the turbulence or distractions caused by the conditions.

MANEUVERS

The airplane is approved for certain aerobatic maneuvers, provided it is loaded within the approved weight and center of gravity limits. (See Airplane Flight Manual.) The maneuvers are spins, steep turns, lazy eights and chandelles. Spins are prohibited when air conditioning is installed.

Intentional spins are prohibited in the normal category airplane. Lazy eights and chandelles may be performed in the normal category provided a 60° angle of bank and/or a 30° angle of pitch is not exceeded. For approved maneuvers and entry speed refer to the Airplane Flight Manual.

APPROACH AND LANDING

Landing check list:

1. Fuel on proper tank
2. Mixture - full rich
3. Electric fuel pump on
4. Seat backs - erect
5. Flaps - set (115 MPH)
6. Safety Belts/harness - fastened
7. Air conditioner - off

The airplane should be trimmed to an approach speed of about 85 miles per hour with flaps up. The flaps can be lowered at speeds up to 115 miles per hour, approach speed is reduced 3 miles per hour for each notch of flaps used. Carburetor heat should not be applied unless there is an indication of carburetor icing, since the use of carburetor heat causes a reduction in power which may be critical in case of a go-around. Full throttle operation with carburetor heat on is likely to cause detonation.

The amount of flap used during landings and the speed of the aircraft at contact with the runway should be varied according to the landing surface and existing conditions, both windwise and loadwise. It is generally good practice to contact the ground at the minimum possible safe speed consistent with existing conditions.

Normally, the best technique for short and slow landings is to use full flaps and enough power to maintain the desired airspeed and approach flight path. Mixture should be full rich, fuel on the fullest tank, carburetor heat off, and electric fuel pump on. Reduce the speed during the flareout and contact the ground close to the stalling speed (55 to 65 MPH). After ground contact hold the nose wheel off as long as possible. As the airplane slows down, drop the nose and apply the brakes. There will be less chance of skidding the tires if the flaps are retracted before applying the brakes. Braking is most effective when back pressure is applied to the control wheel, putting most of the aircraft weight on the main wheels. In high wind conditions, particularly in strong crosswinds, it may be desirable to approach the ground at higher than normal speeds with partial or no flaps.

STOPPING ENGINE

At the pilot's discretion, the flaps should be raised and the electric fuel pump turned off. After parking, the air conditioner and radios should be turned off and the engine stopped by pulling the mixture control to idle cut-off. The throttle should be left full aft to avoid engine vibration while stopping. Then the magneto and master switches should be turned off and the parking brake set.

AIRSPEED DATA

All airspeeds quoted in this manual are calibrated unless otherwise noted. Calibrated airspeed is indicated airspeed corrected for instrument and position errors. The following table gives the correlation between indicated airspeed and calibrated airspeed if zero instrument error is assumed. This calibration is valid only when flown at maximum gross weight in level flight.

AIRSPEED CORRECTION TABLE

Flaps 0°										
IAS-MPH	60	70	80	90	100	110	120	130	140	150
CAS - MPH	66	75	83	92	101	110	119	128	137	146
Flaps 40°										
IAS - MPH	60	70	80	90	100	110	120			
CAS-MPH	64	72	81	90	99	108	117			

CHEROKEE CRUISER

MOORING

The Cherokee should be moved on the ground with the aid of the nose wheel tow bar provided with each plane and secured in the baggage compartment. Tie downs may be secured to rings provided under each wing, and to the tail skid. The aileron and stabilator controls should be secured by looping the seat belt through the control wheel and pulling it snug. The rudder is held in position by its connections to the nose wheel steering, and normally does not have to be secured. The flaps are locked when in the full up position, and should be left retracted.

WEIGHT AND BALANCE

It is the responsibility of the owner and pilot to determine that the airplane remains within the allowable weight vs. center of gravity envelope while in flight. For weight and balance data see the Airplane Flight Manual and Weight and Balance form supplied with each airplane.

AIR CONDITIONING*

To operate the air conditioning system either on the ground or in flight:

1. Start the engine (ground operation).
2. Turn the air conditioning Master Switch to "ON."
3. Turn "TEMP" control to desired temperature. Clockwise rotation increases cooling.
4. Select desired "FAN" position, "LOW," "MED" or "HIGH."

AIR CONDITIONER OPERATIONAL CHECK PROCEDURE

Prior to takeoff the air conditioner should be checked for proper operation as follows:

1. Check aircraft Master Switch ON.
2. Select desired "FAN" position, "LOW," "MED" or "HIGH."
3. Turn the air conditioner control switch to "ON" - the "Air Cond. Door Open" warning light will turn on, thereby indicating proper air conditioner condenser door actuation.
4. Turn the air conditioner control switch to "OFF" - the "Air Cond. Door Open" warning light will go out, thereby indicating the air conditioner condenser door is in the up position.
5. If the "Air Cond. Door Open" light does not respond as specified above, an air conditioner system or indicator bulb malfunction is indicated, and further investigation should be conducted prior to flight.

The above operational check may be performed during flight if an inflight failure is suspected.

* Optional equipment

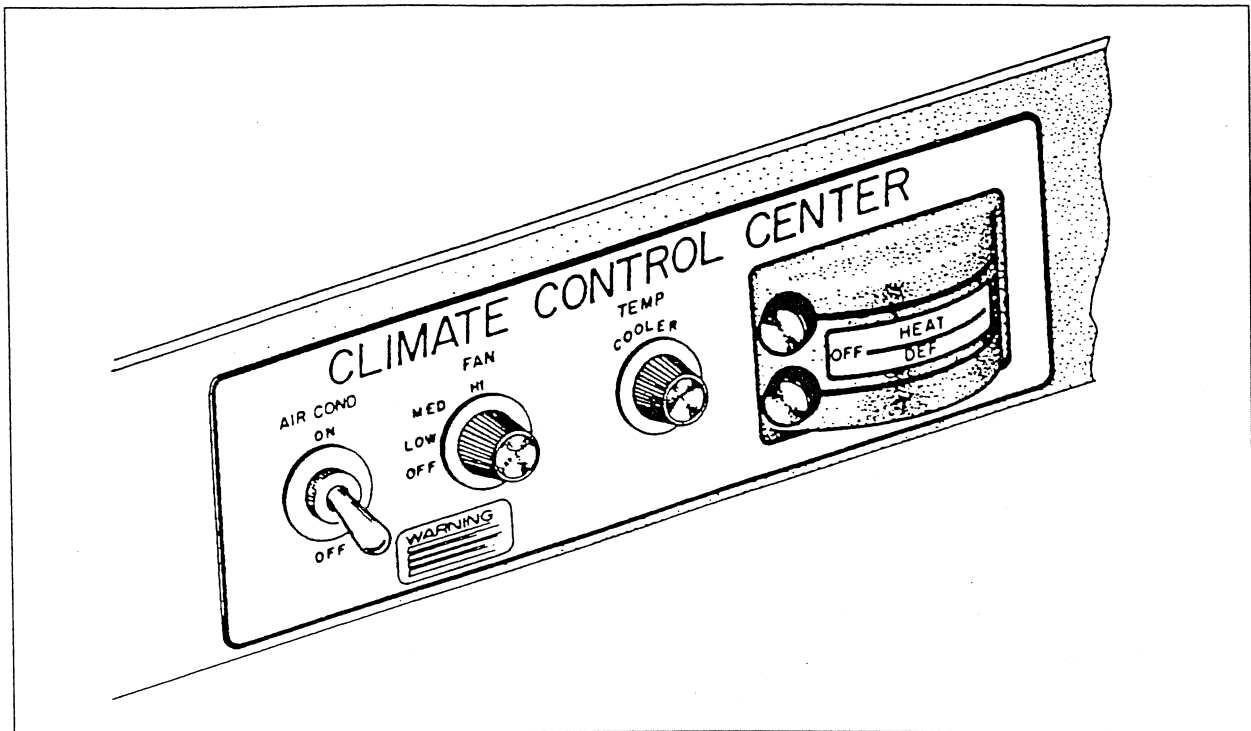

Air Conditioner Controls

AIR CONDITIONER EFFECTS ON AIRPLANE PERFORMANCE

Operation of the air conditioner will cause slight decreases in the cruise speed and range of the Cherokee 140. Power from the engine is required to run the compressor, and the condenser door, when extended, causes a slight increase in drag. When the air conditioner is turned off there is normally no measurable difference in climb, cruise or range performance of the airplane.

NOTE

To insure maximum climb performance the air conditioner must be turned off manually before takeoff to disengage the compressor and retract the condenser door. Also the air conditioner must be turned off manually before the landing approach in preparation for a possible go-around.

Although the cruise speed and range are only slightly affected by the air conditioner operation, these changes should be considered in preflight planning. To be conservative, the following figures assume that the compressor is operating continuously while the airplane is airborne. This will be the case only in extremely hot weather.

1. The decrease in true airspeed is approximately 5 mph at 75% power and 4 mph at 50% power.
2. The decrease in range may be as much as 28 statute miles for the 36 gal. (standard) capacity and as much as 39 statute miles for the 50 gal. (reserve) capacity.

NOTE

To read power from the Power vs. Density Altitude Chart in this manual, add 50 rpm to the value observed on the tachometer when the air conditioner is operating.

The climb performance of Cherokee 140 is not compromised measurably with the air conditioner operating since the compressor is declutched and the condenser door is retracted, both automatically, when a full throttle position is selected. When the full throttle position is not used or in the event of a malfunction which would cause the compressor to operate and the condenser door to be extended, a decrease in rate of climb of as much as 100 fpm can be expected. Should a malfunction occur which prevents condenser door retraction when the compressor is turned off, a decrease in rate of climb of as much as 50 fpm can be expected.

EMERGENCY LOCATOR TRANSMITTER*

The Emergency Locator Transmitter (ELT) when installed, is located in the aft portion of the fuselage just below the stabilator leading edge and is accessible through a plate on the right side of the fuselage. (On aircraft manufactured prior to mid-1975, this plate is retained by three steel Phillips head screws. On aircraft manufactured from mid-1975 and on, this plate is attached with three slotted-head nylon screws for ease of removal; these screws may be readily removed with a variety of common items such as a dime, a key, a knife blade, etc. If there are no tools available in an emergency the screw heads may be broken off by any means.) The ELT is an emergency locator transmitter which meets the requirements of FAR 91.52. The unit operates on a self-contained battery.

A battery replacement date is marked on the transmitter label. To comply with FAA regulations, the battery must be replaced on or before this date. The battery must also be replaced if the transmitter has been used in an emergency situation or if the accumulated test time exceeds one hour, or if the unit has been inadvertently activated for an undetermined time period.

On the unit itself is a three position selector switch labeled "OFF," "ARM" and "ON." The "ARM" position is provided to set the unit to the automatic position so that it will transmit only after impact and will continue to transmit until the battery is drained to depletion or until the switch is manually moved to the "OFF" position. The "ARM" position is selected when the transmitter is installed at the factory and the switch should remain in that position whenever the unit is installed in the airplane. The "ON" position is provided so the unit can be used as a portable transmitter or in the event the automatic feature was not triggered by impact or to periodically test the function of the transmitter.

Select the "OFF" position when changing the battery, when rearming the unit if it has been activated for any reason, or to discontinue transmission.

* Optional equipment

NOTE

If the switch has been placed in the "ON" position for any reason, the "OFF" position has to be selected before selecting "ARM." If "ARM" is selected directly from the "ON" position, the unit will continue to transmit in the "ARM" position.

A pilot's remote switch, located on the left side panel, is provided to allow the transmitter to be controlled from inside the cabin.

1. On some models the pilot's remote switch has three positions and is placarded "ON," "AUTO/ARM," and "OFF/RESET." The switch is normally left in the "AUTO/ARM" position. To turn the transmitter off, move the switch momentarily to the "OFF/RESET" position. The aircraft master switch must be "ON" to turn the transmitter "OFF." To activate the transmitter for tests or other reasons, move the switch upward to the "ON" position and leave it in that position as long as transmission is desired.
2. On other models the pilot's remote switch has two positions and is placarded "ON/RESET" and "ARM (NORMAL POSITION)." The switch is normally left in the down or "ARM" position. To turn the transmitter off, move the switch to the "ON/RESET" position for one second then return it to the "ARM" position. To activate the transmitter for tests or other reasons, move the switch upward to the "ON/RESET" position and leave it in that position as long as transmission is desired.

The locator should be checked during the ground check to make certain the unit has not been accidentally activated. Check by tuning a radio receiver to 121.5 MHz. If there is an oscillating sound, the locator may have been activated and should be turned off immediately. Reset to the "ARM" position and check again to insure against outside interference.

NOTE

If for any reason a test transmission is necessary, the test transmission should be conducted only in the first five minutes of any hour and limited to three audio sweeps. If tests must be made at any other time, the tests should be coordinated with the nearest FAA tower or flight service station.

BLANK PAGE

OPERATING TIPS

The following Operating Tips are of particular value in the operation of the Cherokee 140.

1. Learn to trim for takeoff so that only a very light back pressure on the wheel is required to lift the airplane off the ground.
2. The best speed for takeoff is about 60 MPH under normal conditions. Trying to pull the airplane off the ground at too low an airspeed decreases the controllability of the airplane in event of engine failure.
3. Flaps may be lowered at airspeeds up to 115 MPH. To reduce flap operating loads, it is desirable to have the airplane at a slower speed before extending the flaps.
4. Before attempting to reset any circuit breaker, allow a two to five minute cooling off period.
5. Before starting the engine, check that all radio switches, light switches and the pitot heat switch are in the off position so as not to create an overloaded condition when the starter is engaged.
6. The overvoltage relay is provided to protect the electronics equipment from a momentary overvoltage condition (approximately 16.5 volts and up), or a catastrophic regulator failure. In the event of a momentary condition, the relay will open and the ammeter will indicate "0" output from the alternator. The relay may be reset by switching the ALT switch to OFF for approximately 1 second and then returning the ALT switch to ON. If after recycling the ALT switch the condition persists, the flight should be terminated as soon as practical; reduce the battery load to a minimum. The ALT light on the annunciator panel* will illuminate if the alternator fails. Recycle the ALT switch and check the ALT FIELD circuit breaker. If the failure persists after this action, reduce electrical loads and land as soon as practical,
7. The vacuum gauge is provided to monitor the pressure available to assure the correct operating speed of the vacuum driven gyroscopic flight instruments. It also monitors the condition of the common air filter by measuring the flow of air through the filter.

If the vacuum gauge does not register $5" \pm .10"$ Hg at 2000 RPM, the following items should be checked before flight:

- a. Common air filter could be dirty or restricted.
- b. Vacuum lines could be collapsed or broken.
- c. Vacuum pump worn.
- d. Vacuum regulator, not adjusted correctly. The pressure, even though set correctly, can read lower under two conditions: (1) Very high altitude, above 12,000 feet, (2) Low engine RPM, usually on approach or during training maneuvers. This is normal and should not be considered a malfunction.

* Serial nos. 28-7525001 through 28-7625275

8. The shape of the wing fuel tanks is such that in certain maneuvers the fuel may move away from the tank outlet. If the outlet is uncovered, the fuel flow will be interrupted and a temporary loss of power may result. Pilots can prevent inadvertent uncovering of the outlet by avoiding maneuvers which could result in uncovering the outlet.

Extreme running turning takeoffs should be avoided as fuel flow interruption may occur.

Prolonged slips or skids which result in excess of 2000 feet of altitude loss, or other radical or extreme maneuvers which could cause uncovering of the fuel outlet must be avoided as fuel flow interruption may occur when tank being used is not full.

9. Anti-collision lights should not be operating when flying through overcast and clouds, since reflected light can produce spacial disorientation. Do not operate strobe lights when taxiing in the vicinity of other aircraft.
10. The rudder pedals are suspended from a torque tube which extends across the fuselage. The pilot should become familiar with the proper positioning of his feet on the rudder pedals so as to avoid interference with the torque tube when moving the rudder pedals or operating the toe brakes.
11. In an effort to avoid accidents, pilots should obtain and study the safety related information made available in FAA publications such as regulations, advisory circulars, Aviation News, AIM and safety aids.
12. During letdown and low power flight operations, it may be necessary to lean because of excessively rich mixture. Always go to full rich prior to landing sequence.
13. When leaning, careful observation of the temperature instruments should be practiced.
14. When alternate fuels are used, the engine should be run up to 1200 RPM for one minute prior to shutdown to clean out any unburned fuel.

PERFORMANCE CHARTS

Altitude Conversion Chart.....	9-1
Takeoff Performance	9-2
Climb Performance.....	9-3
Engine Performance	9-4
Cruise Performance - True Airspeed	9-5
Cruise Performance - Range (Standard Fuel Capacity).....	9-6
Cruise Performance - Range (Maximum Fuel Capacity)	9-7
Glide Performance	9-8
Stall Speed vs Aircraft Gross Weight	9-9
Stall Speed vs Angle of Bank	9-10
Landing Performance	9-11

WARNING

PERFORMANCE INFORMATION DERIVED BY EXTRAPO-
LATION BEYOND THE LIMITS SHOWN ON THE CHARTS
SHOULD NOT BE USED FOR FLIGHT PLANNING PURPOSES.

BLANK PAGE

PA-28-140 CHEROKEE

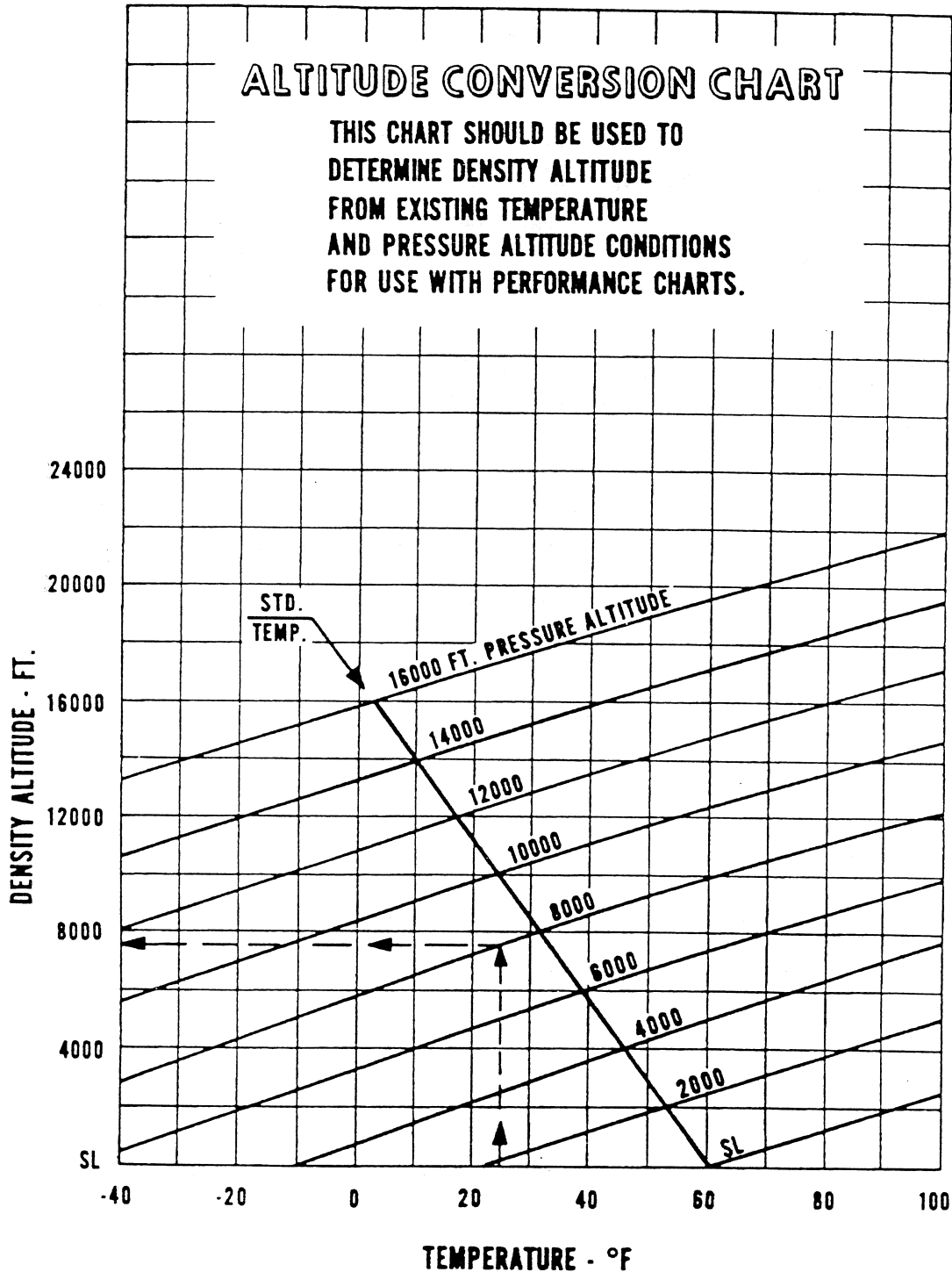

PA-28-140 CHEROKEE

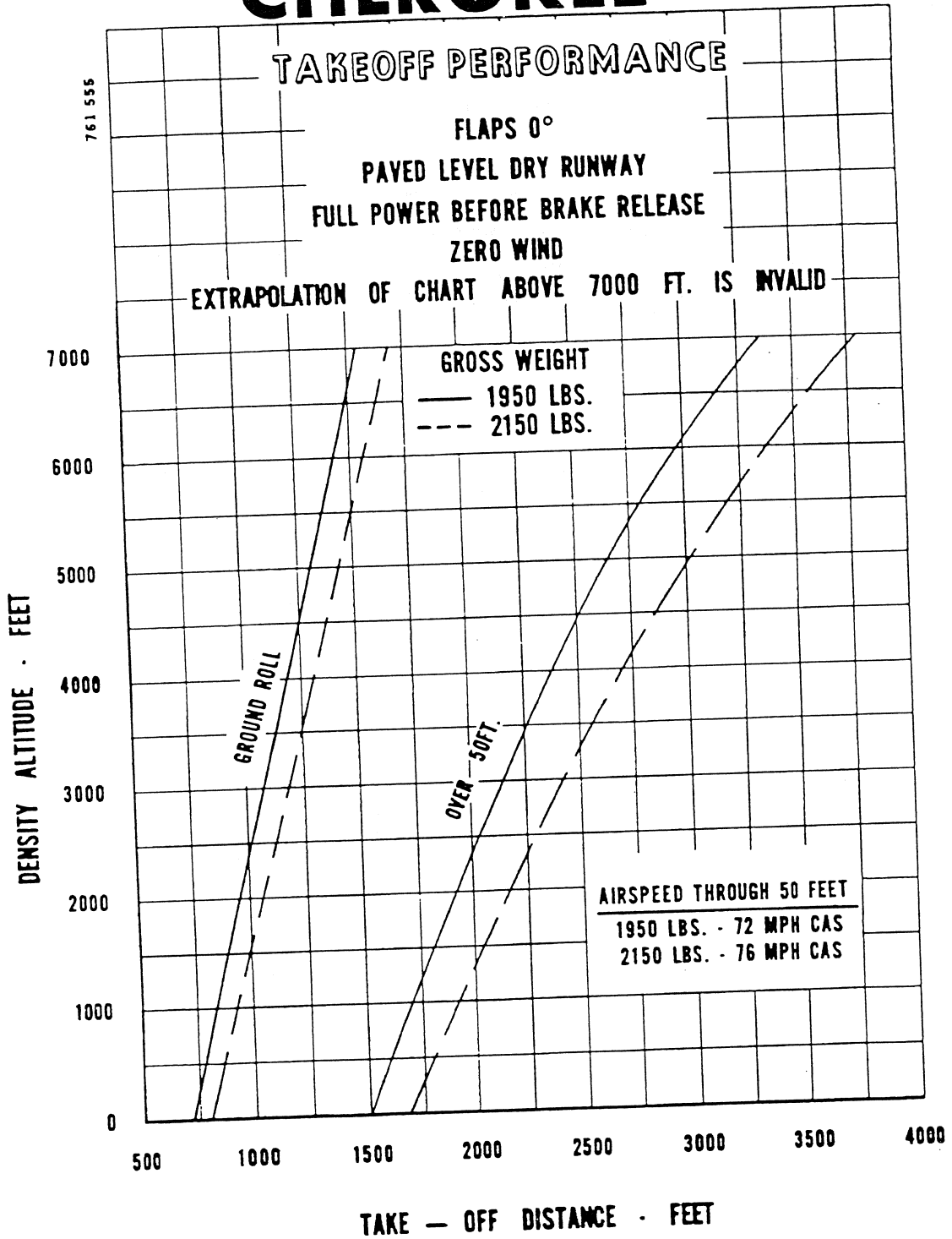

NOTE: SEE SECTION 7 FOR EFFECTS OF AIR CONDITIONING
INSTALLATION ON PERFORMANCE.

PERFORMANCE CHART
REVISED: JUNE 13, 1974

PA-28-140 CHEROKEE

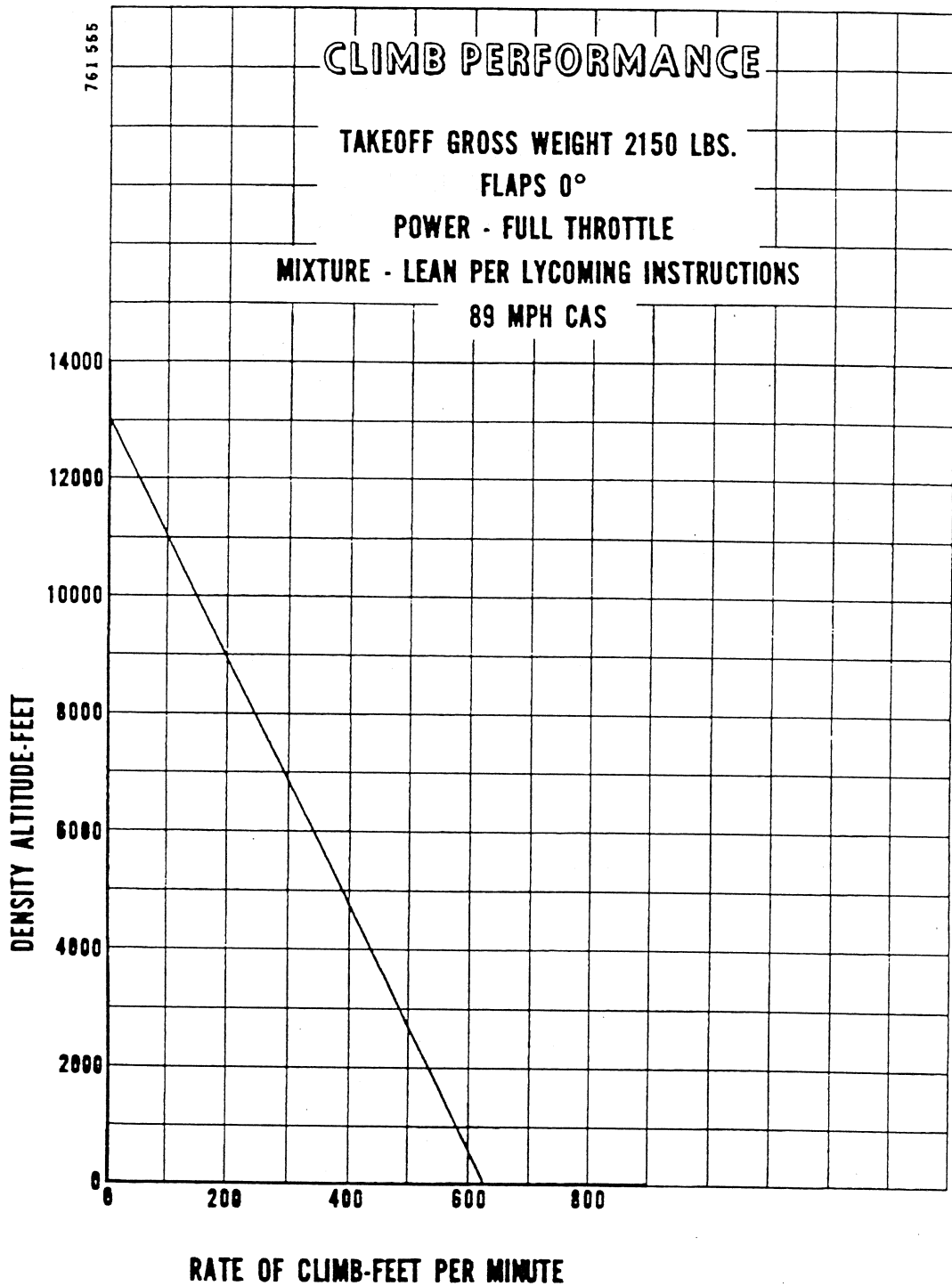

NOTE: SEE SECTION 7 FOR EFFECTS OF AIR CONDITIONING
INSTALLATION ON PERFORMANCE.

PA-28-140 CHEROKEE

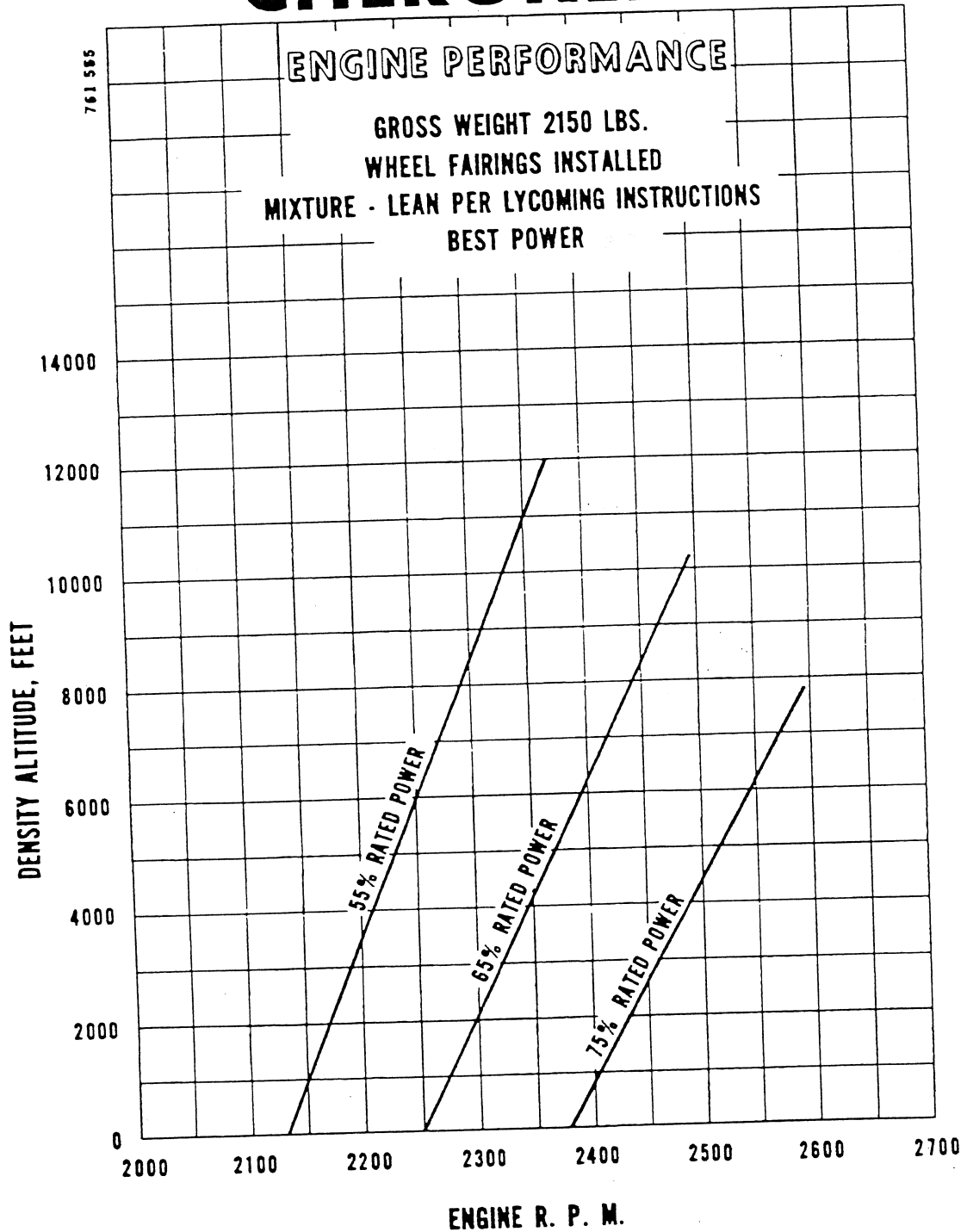

NOTE: SEE SECTION 7 FOR EFFECTS OF AIR CONDITIONING
INSTALLATION ON PERFORMANCE.

PA-28-140 CHEROKEE

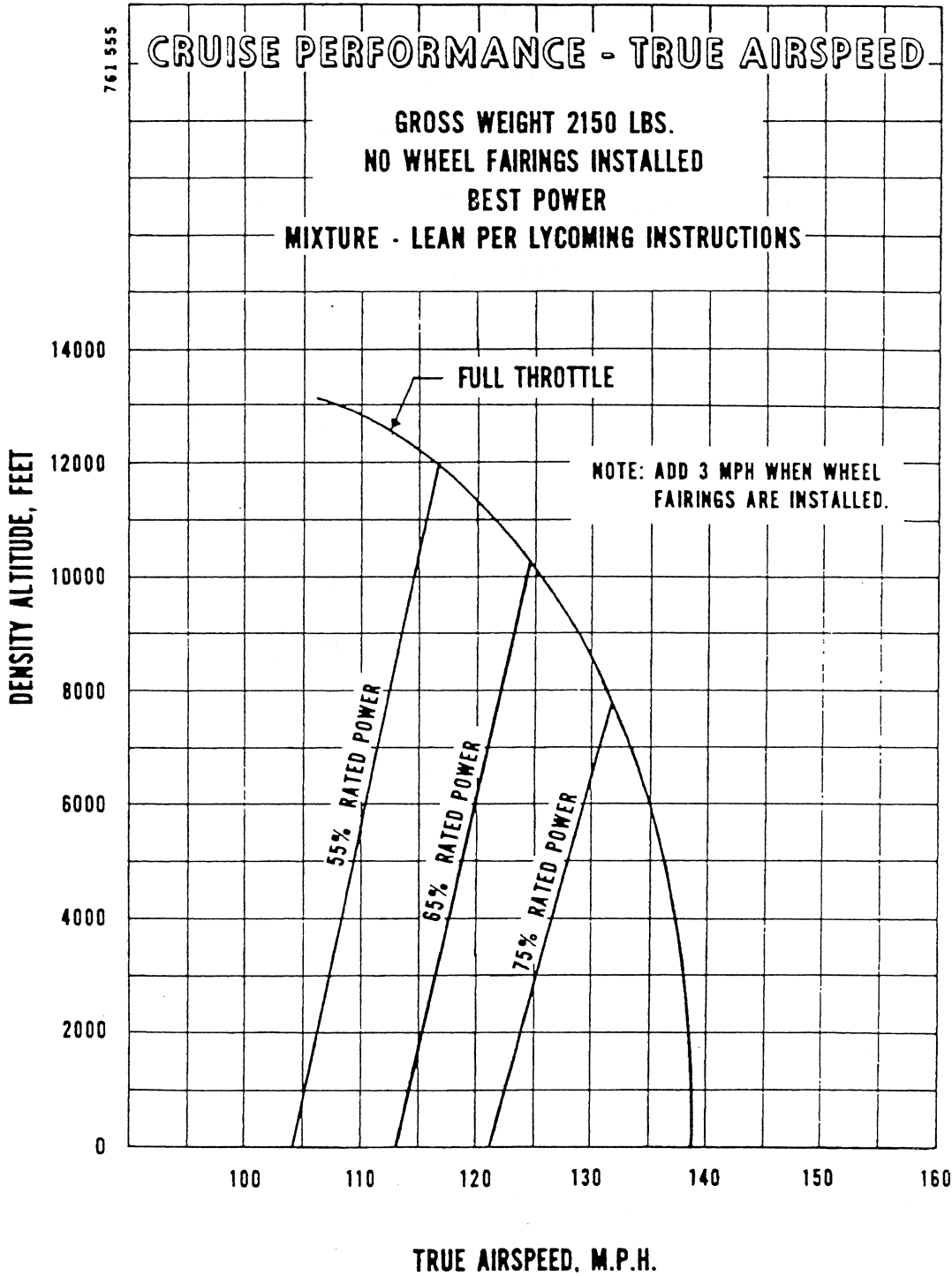

NOTE: SEE SECTION 7 FOR EFFECTS OF AIR CONDITIONING INSTALLATION ON PERFORMANCE.

PA-28-140 CHEROKEE

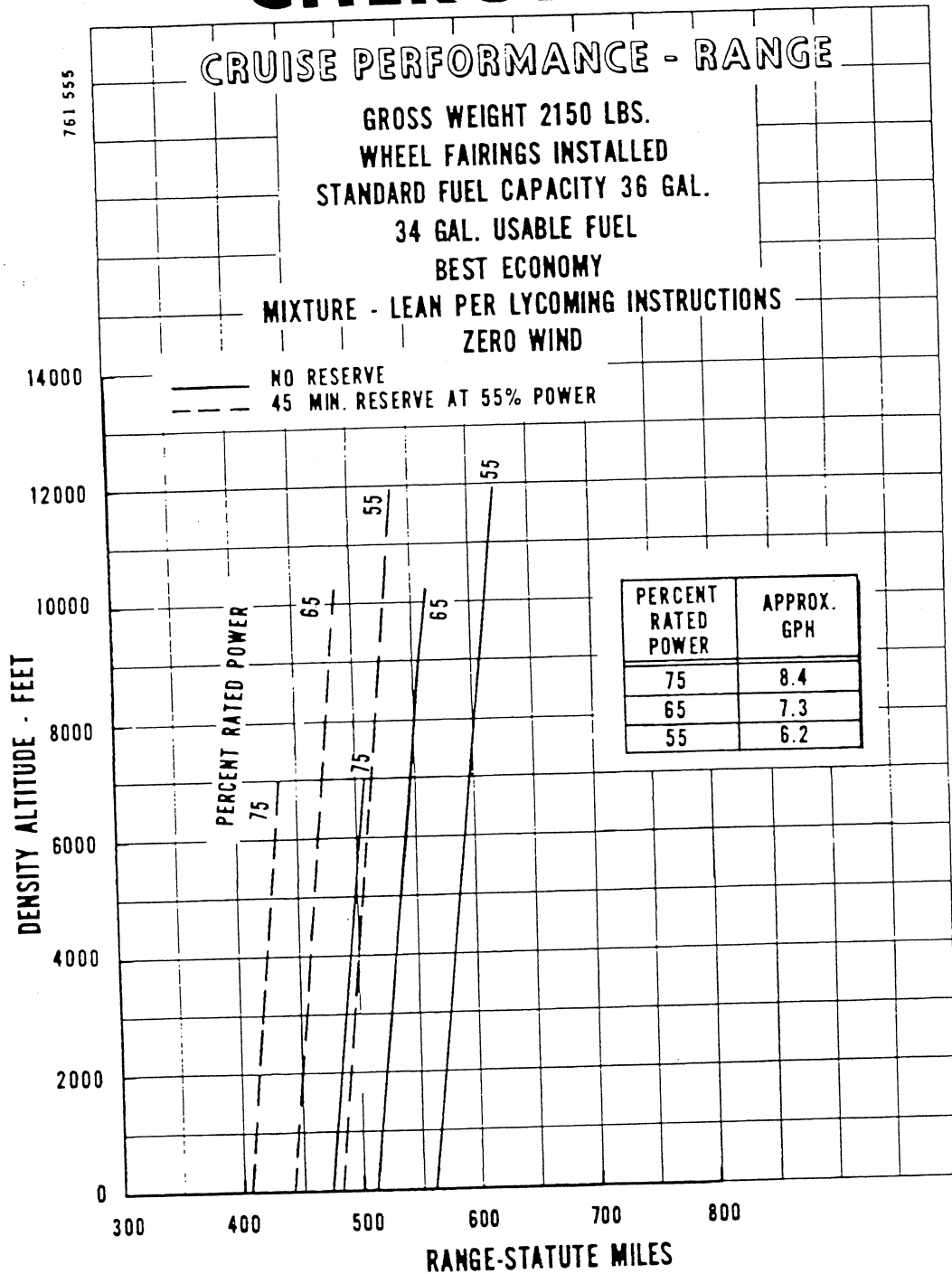

NOTE: SEE SECTION 7 FOR EFFECTS OF AIR CONDITIONING
INSTALLATION ON PERFORMANCE.

PERFORMANCE CHARTS
REVISED: JUNE 13, 1974

PA-28-140 CHEROKEE

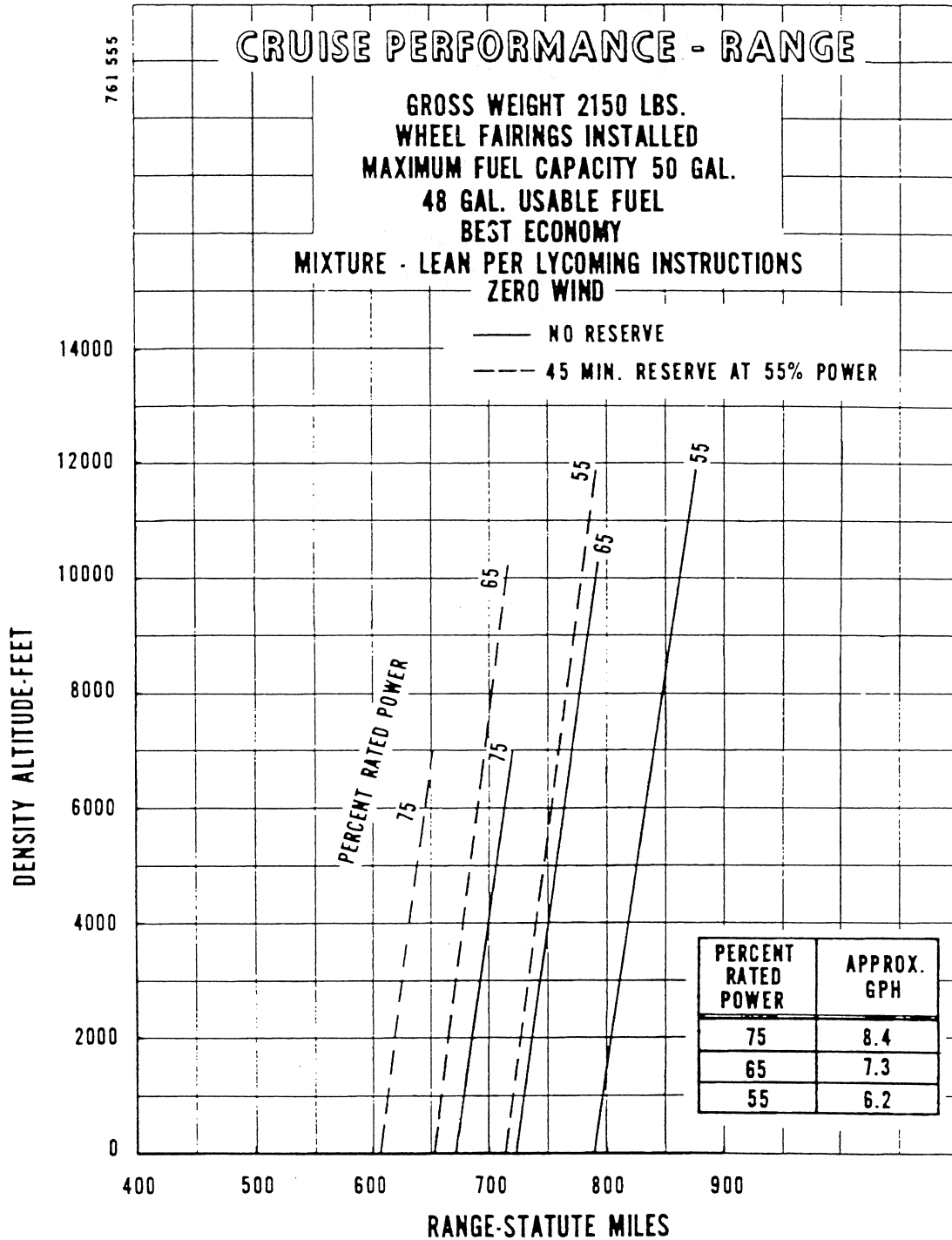

NOTE: SEE SECTION 7 FOR EFFECTS OF AIR CONDITIONING INSTALLATION ON PERFORMANCE.

PA-28-140 CHEROKEE

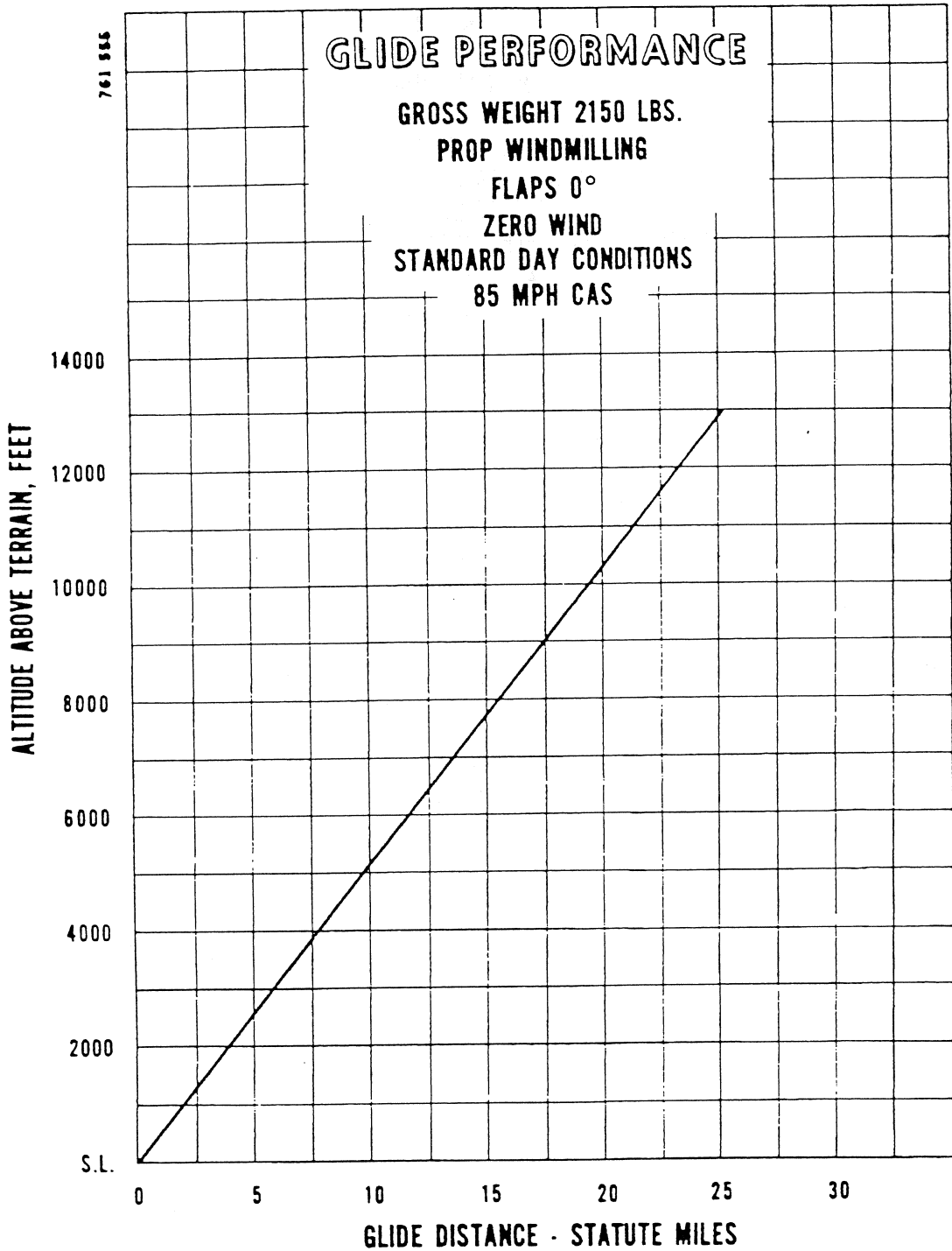

NOTE: SEE SECTION 7 FOR EFFECTS OF AIR CONDITIONING
INSTALLATION ON PERFORMANCE.

PA-28-140 CHEROKEE

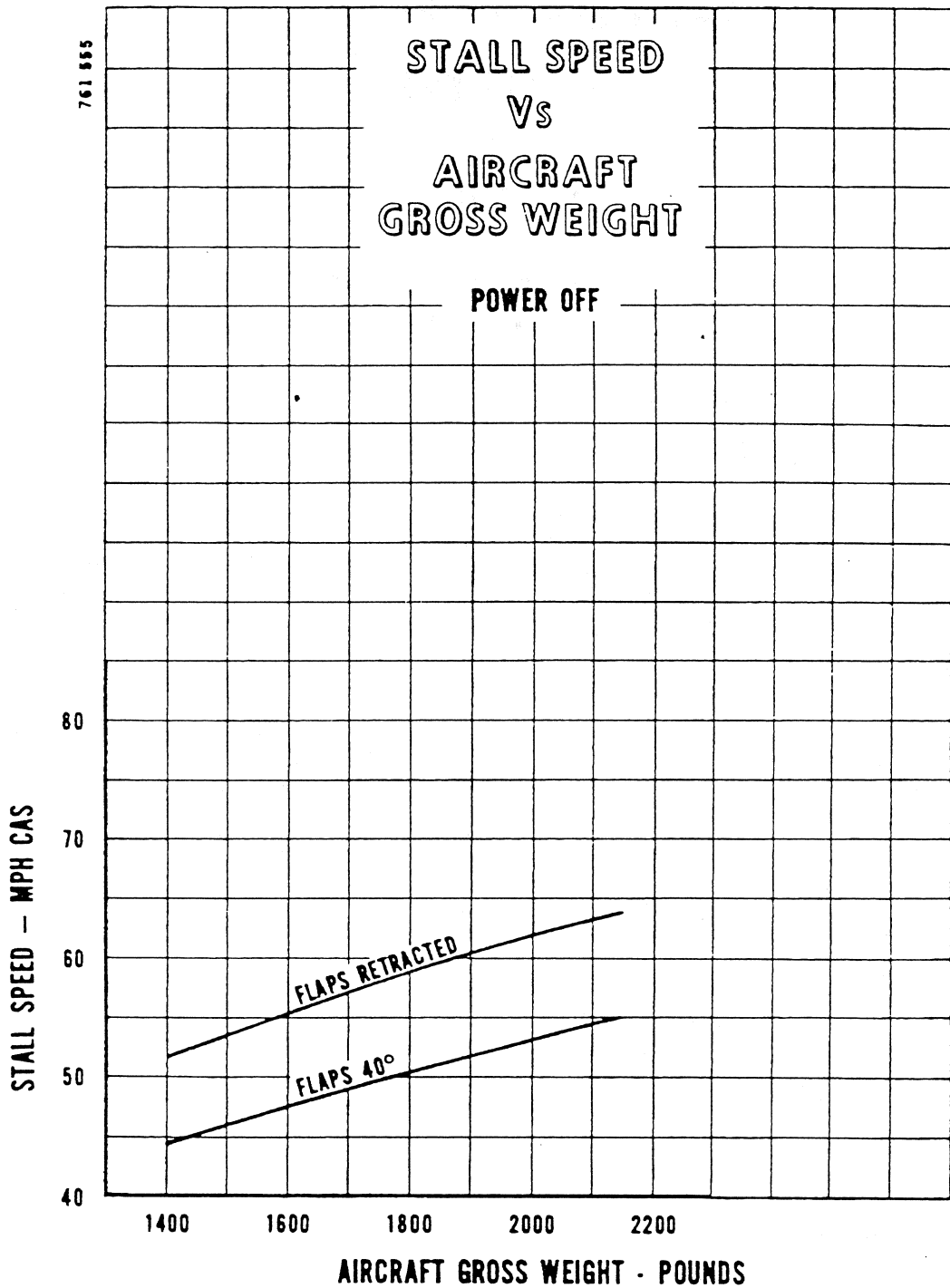

NOTE: SEE SECTION 7 FOR EFFECTS OF AIR CONDITIONING
INSTALLATION ON PERFORMANCE.

PA-28-140 CHEROKEE

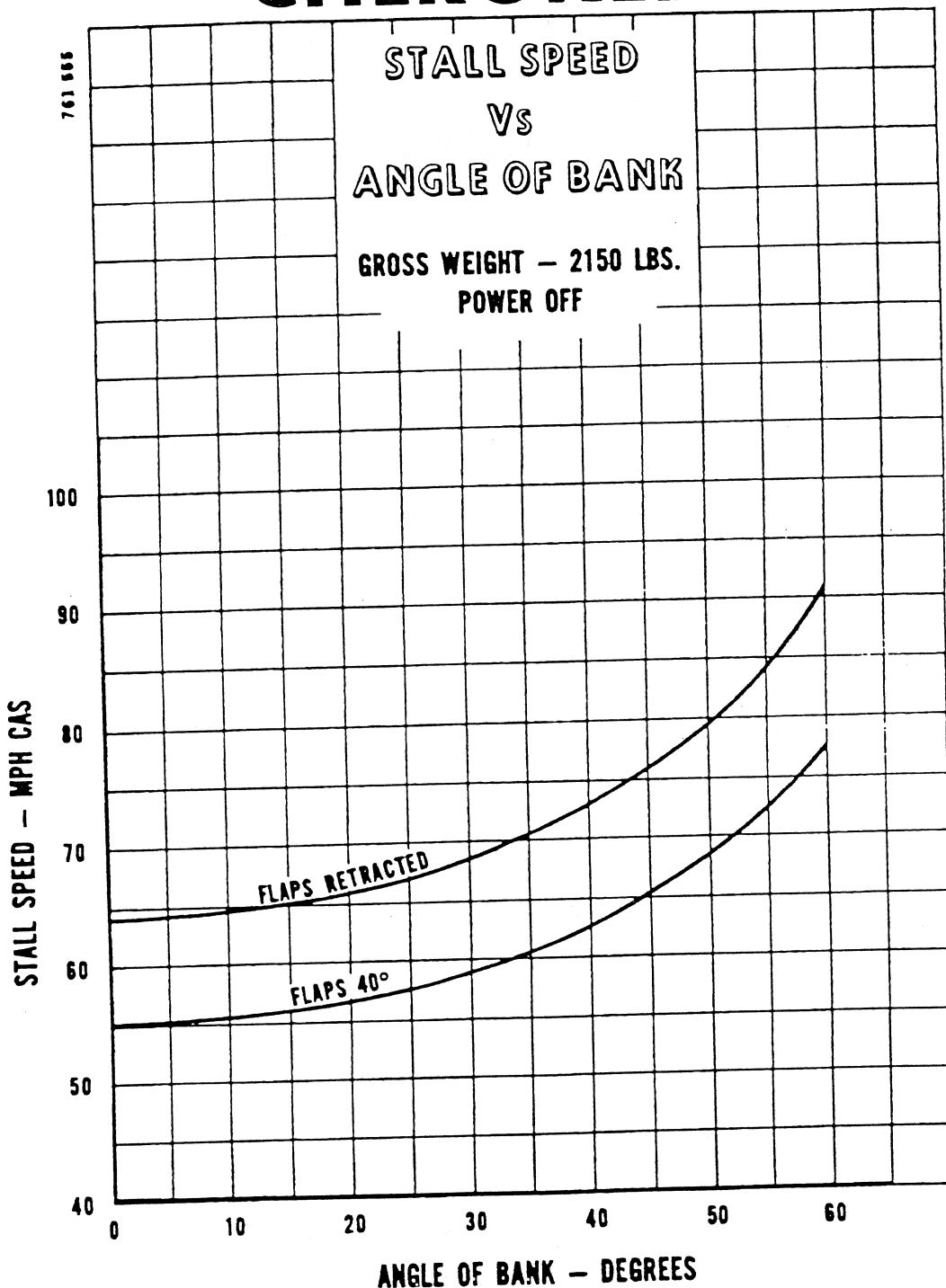

NOTE: SEE SECTION 7 FOR EFFECTS OF AIR CONDITIONING
INSTALLATION ON PERFORMANCE.

PERFORMANCE CHARTS
REVISED: JUNE 13, 1974

PA-28-140 CHEROKEE

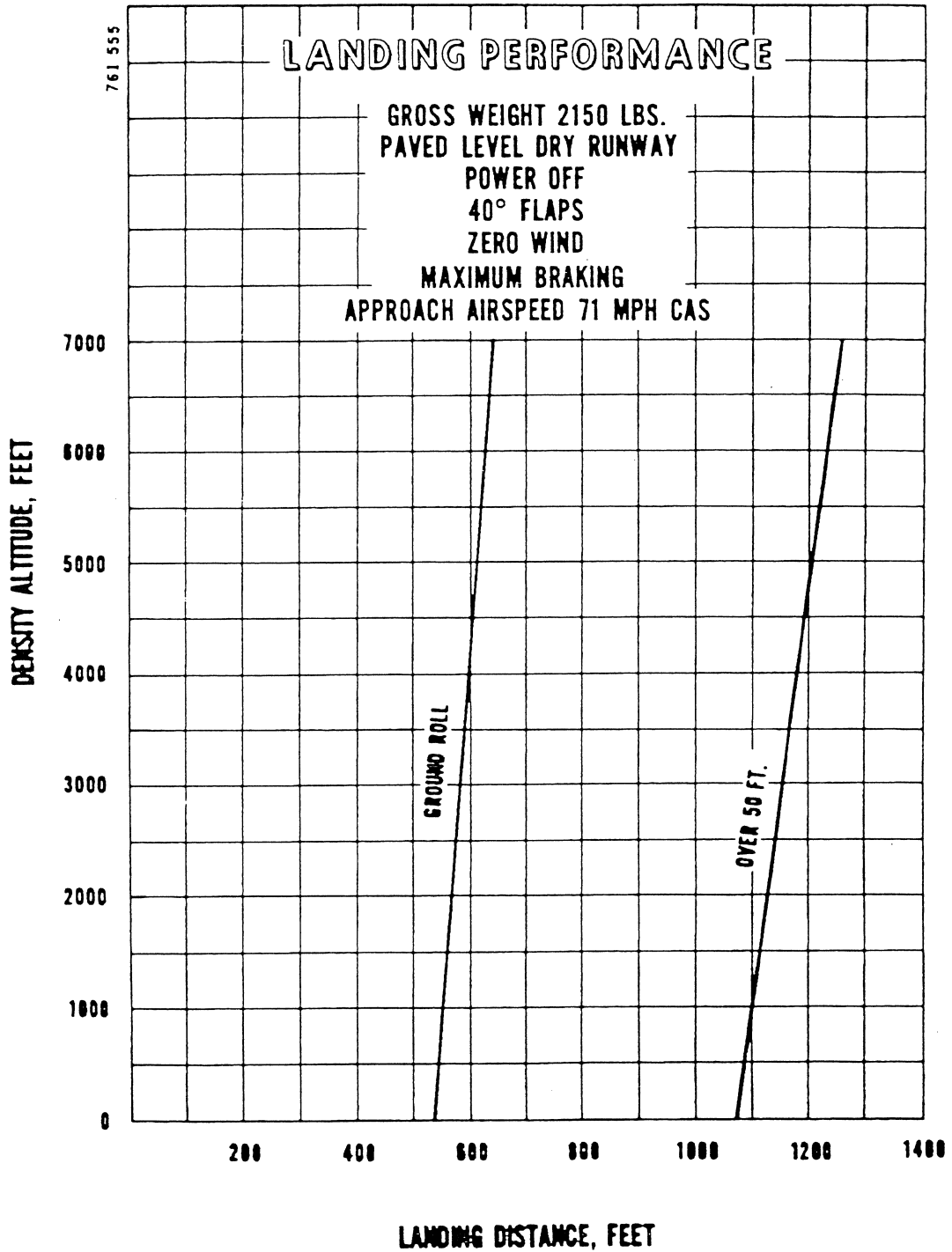

NOTE: SEE SECTION 7 FOR EFFECTS OF AIR CONDITIONING
INSTALLATION ON PERFORMANCE.

HANDLING AND SERVICING

Ground Handling	10-1
Towing	10-1
Taxiing	10-1
Parking	10-2
Mooring	10-2
Cleaning	10-3
Cleaning Engine Compartment	10-3
Cleaning Landing Gear	10-3
Cleaning Exterior Surfaces.....	10-4
Cleaning Windshield and Windows	10-4
Cleaning Headliner, Side Panels and Seats	10-5
Cleaning Carpets	10-5
Power Plant Induction Air Filter	10-5
Removal of Induction Air Filter.....	10-5
Cleaning Induction Air Filter	10-5
Installation of Induction Air Filter	10-5
Brake Service	10-7
Landing Gear Service	10-7
Propeller Service.....	10-8
Oil Requirements	10-8
Fuel System	10-8
Fuel Requirements.....	10-8
Filling Fuel Tanks.....	10-9
Draining Fuel Valves and Lines	10-10
Draining Fuel System.....	10-10
Tire Inflation	10-10
Battery Service	10-10
Facts You Should Know	10-11
Preventive Maintenance	10-12
Required Service and Inspection Periods	10-13

BLANK PAGE

HANDLING AND SERVICING

This section contains information on preventive maintenance. Refer to the Cherokee 140 Service Manual for further maintenance procedures. Any complex repair or modification should be accomplished by a Piper Certified Service Center.

GROUND HANDLING

TOWING

The airplane may be moved by using the nose wheel steering bar provided, or power equipment that will not damage or cause excess strain to the nose gear assembly. The steering bar is stowed in the baggage compartment.

CAUTION

When towing with power equipment, do not turn nose gear more than 30 degrees in either direction, as this will result in damage to the nose gear and steering mechanism.

TAXIING

Before attempting to taxi the airplane, ground personnel should be instructed and approved by a qualified person authorized by the owner. Engine starting and shut-down procedures as well as taxi techniques should be covered. When it is ascertained that the propeller back blast and taxi areas are clear, power should be applied to start the taxi roll, and the following checks should be performed.

- a. Taxi forward a few feet and apply brakes to determine their effectiveness.
- b. While taxiing, make slight turns to ascertain the effectiveness of the steering.
- c. Observe wing clearances when taxiing near buildings or other stationary objects. If possible, station a guide outside the airplane to observe.
- d. When taxiing on uneven ground, look for holes and ruts.
- e. Do not operate the engine at high RPM when running up or taxiing over ground containing loose stones, gravel or any loose material that may cause damage to the propeller blades.

PARKING

When parking the airplane, insure that it is sufficiently protected against adverse weather conditions and presents no danger to other aircraft. When parking the airplane for any length of time or overnight, it is recommended that it be moored securely.

- a. To park the airplane, head it into the wind, if possible.
- b. Set the parking brake. (Use wheel chocks if available.)

NOTE

Care should be taken when setting brakes that are overheated or during cold weather when accumulated moisture may freeze a brake.

MOORING

The airplane should be moored to insure its immovability, protection and security under varying weather conditions. The following procedure should be used for proper mooring of the airplane.

- a. Head the airplane into the wind, if possible.
- b. Lock the aileron and stabilator controls by looping the seat belt through the control wheel and pulling it snug.
- c. Block the wheels.
- d. Secure tie down ropes to the wing tie down rings and tail skid at approximately 45-degree angles to the ground. When using rope of non-synthetic material, leave sufficient slack to avoid damage to the airplane should the ropes contract.

CAUTION

Use bowline knots or locked slip knots. Do not use a plain slip knot.

NOTE

Additional preparations for high winds include using tie-down ropes from the landing gear forks, and securing the rudder.

- e. Install a pitot head cover, if available.

CLEANING

CLEANING ENGINE COMPARTMENT

Before cleaning the engine compartment, place a strip of tape on the magneto vents to prevent solvent from entering these units.

- a. Place a large pan under the engine to catch waste.
- b. With the engine cowling removed, spray or brush the engine with solvent or a mixture of solvent and degreaser, as desired. Where heavy grease and dirt deposits have collected, it may be necessary to brush areas that were sprayed in order to clean them.

CAUTION

Do not spray solvent into the alternator, vacuum pump, starter or air intakes.

- c. Allow the solvent to remain on the engine from five to ten minutes. Then rinse the engine clean with additional solvent and allow to dry.

CAUTION

Do not operate the engine until excess solvent has evaporated or otherwise been removed.

- d. Remove the protective covers from the magnetos.
- e. Lubricate controls, bearing surfaces, etc., in accordance with the Lubrication Chart.

CLEANING LANDING GEAR

Before cleaning the landing gear, place a plastic cover or similar material over the wheel and brake assembly.

- a. Place a pan under the gear to catch waste.
- b. Spray or brush the gear area with solvent or a mixture of solvent and degreaser, as desired. Where heavy grease and dirt deposits have collected, it may be necessary to brush areas that were sprayed in order to clean them.
- c. Allow the solvent to remain on the gear from five to ten minutes. Then rinse the gear with additional solvent and allow to dry.
- d. Remove the cover from the wheel and remove the catch pan.
- e. Lubricate the gear in accordance with the Lubrication Chart.

CLEANING EXTERIOR SURFACES

The airplane should be washed with a mild soap and water. Harsh abrasive or alkaline soaps or detergents used on painted or plastic surfaces could make scratches or cause corrosion of metal surfaces. Cover areas where cleaning solution could cause damage. To wash the airplane, the following procedure may be used:

- a. Flush away loose dirt with water.
- b. Apply cleaning solution with a rag, sponge or soft bristle brush.
- c. To remove stubborn oil and grease, use a cloth dampened with naphtha.
- d. Where exhaust stains exist, allow solution to remain on the surface longer.
- e. Any good automotive wax may be used to preserve the painted surfaces. Soft cleaning cloths or a chamois should be used to prevent scratches when cleaning or polishing. A heavier coating of wax on the leading surfaces will reduce the abrasion problems in these areas.

CLEANING WINDSHIELD AND WINDOWS

A certain amount of care is needed to keep the plexiglas windows clean and unmarred. The following procedure is recommended:

- a. Remove dirt, mud, and other marks from exterior surface with clean water.
- b. Wash with mild soap and warm water or an aircraft plastic cleaner. Use a soft cloth or sponge using a straight rubbing motion. Do not rub surface harshly.
- c. Remove oil and grease with a cloth moistened with kerosene.

NOTE

Do not use gasoline, alcohol, benzene, carbon tetrachloride, thinner, acetone, or window cleaning sprays.

- d. After cleaning plastic surfaces, apply a thin coat of hard polishing wax. Rub lightly with a soft cloth. Do not use a circular motion.
- e. A severe scratch or mar in plastic can be removed by using jeweler's rouge to rub out the scratch. Smooth both sides and apply wax.

CLEANING HEADLINER, SIDE PANELS AND SEATS

- a. Clean headliner, side panels and seats with a stiff bristle brush, and vacuum where necessary.
- b. Soiled upholstery, except leather, may be cleaned by using an approved foam upholstery cleaner. Carefully follow the manufacturer's instructions. Avoid soaking or harsh rubbing.

CAUTION

Solvent cleaners require adequate ventilation.

CLEANING CARPETS

Use a small whisk broom or vacuum cleaner to remove dirt. For soiled spots, use a nonflammable dry cleaning fluid.

POWER PLANT INDUCTION AIR FILTER

The induction air filter must be cleaned at least once every fifty hours. Under extremely adverse conditions of operation it may be necessary to clean the filter daily. Extra filters are inexpensive and a spare should be kept on hand and used as a rapid replacement.

REMOVAL OF INDUCTION AIR FILTER

The air filter is located below the spinner assembly. If a landing light is installed, it will be within the center of the filter assembly. To remove the filter:

- a. Open the cowl.
- b. Remove the thumb screw on the back of the filter assembly.
- c. Remove the retainer assembly. If a landing light is installed, disconnect the wires.
- d. Remove the filter.

CLEANING INDUCTION AIR FILTER

- a. Tap filter gently to remove dirt particles. Do not use compressed air or cleaning solvents.
- b. Inspect filter. If paper element is torn or ruptured or gasket is damaged, the filter should be replaced. The usable life of the filter should be restricted to one year or 500 hours, whichever comes first.

INSTALLATION OF INDUCTION AIR FILTER

After cleaning or replacing the filter, install it in the reverse order of removal.

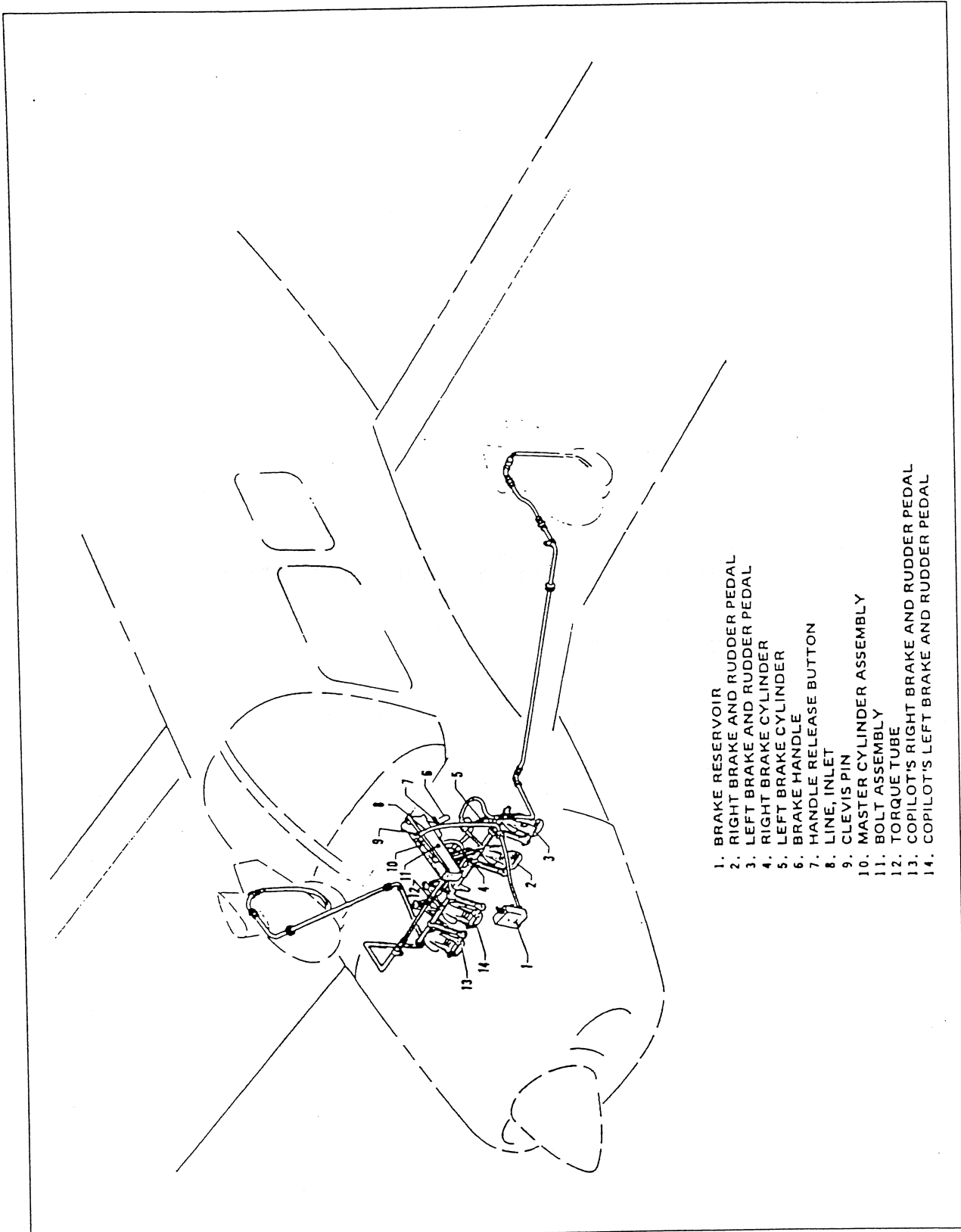

- 1. BRAKE RESERVOIR
- 2. RIGHT BRAKE AND RUDDER PEDAL
- 3. LEFT BRAKE AND RUDDER PEDAL
- 4. RIGHT BRAKE CYLINDER
- 5. LEFT BRAKE CYLINDER
- 6. BRAKE HANDLE
- 7. HANDLE RELEASE BUTTON
- 8. LINE, INLET
- 9. CLEVIS PIN
- 10. MASTER CYLINDER ASSEMBLY
- 11. BOLT ASSEMBLY
- 12. TORQUE TUBE
- 13. COPILOT'S RIGHT BRAKE AND RUDDER PEDAL
- 14. COPILOT'S LEFT BRAKE AND RUDDER PEDAL

Brake System

BRAKE SERVICE

The brake system is filled with MIL-H-5606 (petroleum base) hydraulic brake fluid. This should be checked at every 50 hour inspection and replenished when necessary by filling the brake reservoir on the fire wall to the indicated level. If the entire system has to be refilled, it should be done by filling from the brake end of the system with fluid under pressure. This will eliminate air from the system.

No adjustment of brake clearances is necessary on the Cherokee. If after extended service the brake blocks become worn excessively, they are easily replaced with new segments.

LANDING GEAR SERVICE

Main wheels are removed by taking off the wheel fairings, hub cap, axle nut, retainer pin, and the two bolts holding the brake segment in place. The wheel will slip easily from the axle.

Tires are removed from the wheels by first deflating the tire, then removing the through bolts, and separating the wheel halves.

Landing gear oleo struts should be checked for proper strut exposures and fluid leads. The required extensions for the strut when under normal static load (basic empty weight of airplane plus full fuel and oil) are 3-1/4 inches for the nose gear and 4-1/2 inches for the main gear. Should the strut exposure be below that required, it should be determined whether air or oil is required by first raising the airplane on jacks. Depress the valve core to allow air to escape from the strut housing chamber. Remove the filler plug and slowly raise the strut to full compression. If the strut has sufficient fluid, it will be visible up to the bottom of the filler plug hole and will then require only proper inflation.

Should fluid be below the bottom of the filler plug hole, oil should be added. Replace the plug with valve core removed: attach a clear plastic hose to the valve stem of the filler plug and submerge the other end in a container of hydraulic fluid (MIL-H-5606). Fully compress and extend the strut several times, thus drawing fluid from the container and expelling air from the strut chamber. To allow fluid to enter the bottom chamber of the main gear strut housing, the torque link assembly must be disconnected to let the strut be extended a minimum of 10 inches (the nose gear torque links need not be disconnected). Do not allow the strut to extend more than 12 inches. When air bubbles cease to flow through the hose, compress the strut fully and again check fluid level. Reinstall the valve core and filler plug, and the main gear torque links, if disconnected.

With fluid in the strut housing at the correct level, attach a strut pump to the air valve and with the airplane on the ground, inflate the oleo strut to the correct height.

In jacking the Cherokee for landing gear service, a jack kit (available through the Piper Dealers and Distributors) should be used. This kit consists of two hydraulic jacks and a tail stand. At least 350 pounds of ballast should be placed on the tail stand before jacking the aircraft. The jacks should be placed under the jack points on the wing and the airplane jacked up until the tail skid is at the right height to attach the tail stand. After attaching the tail stand and adding ballast, jacking may be continued until the aircraft is at the height desired.

PROPELLER SERVICE

The spinner and backing plate should be cleaned and inspected frequently for cracks. The propeller should be inspected before each flight for nicks, scratches, and corrosion. If found, they should be taken care of as soon as possible by a rated mechanic, because nicks and scratches cause areas of increased stress which can cause serious damage or loss of a propeller tip. The back face of the blades should be painted when necessary with flat black paint to retard glare to the pilot's eyes. To prevent corrosion the surface should be cleaned and waxed periodically.

OIL REQUIREMENTS

The oil capacity of the Lycoming O-320 series engines is 8 quarts, and the minimum safe quantity is 2 quarts. It is recommended that engine oil be drained and renewed every 50 hours. The oil filter element should be changed every 50 hours of-operation. The interval between oil and oil filter changes should not exceed a total of four (4) months. Under unfavorable dusty conditions, the oil and oil filter should be changed more frequently. Should fuel other than the specified octane rating for the power plant be used, refer to the latest issue of Lycoming Service Letter No. L185 for additional information and recommended service procedures.

The following seasonal aviation oil grades and seasonal ambient temperature ranges are recommended.

Average Ambient Temperature	MIL-L-6082B Mineral SAE Grade	MIL-L-22851 Ashless Dispersant SAE Grades
All Temperatures	—	15W-50 or 20W-50
Above 80°F	60	60
Above 60°F	50	40 or 50
30°F to 90°F	40	40
0°F to 70°F	30	30, 40 or 20W40
0°F to 90°F	20W-50	20W-50 or 15W-50
Below 10°F	20	30 or 20W-30

When operating temperatures overlap indicated gauges, use the lighter grade oil.

NOTE

Refer to the latest issue of Textron Lycoming-Service Instruction 1014 (Lubricating Oil Recommendations) for further information.

FUEL SYSTEM

FUEL REQUIREMENTS (AVGAS ONLY)

The minimum aviation grade fuel for the PA-28-140 is 80/87. Since the use of lower grades can cause serious engine damage in a short period of time, the engine warranty is invalidated by the use of lower octanes.

Whenever 80/87 is not available, the lowest lead 100 grade should be used. (See Fuel Grade Comparison Chart, Page 10-9.) Refer to the latest issue of Lycoming Service Instruction No. 1070 for additional information.

The continuous use, more than 25% of the operating time, of the higher leaded fuels can result in increased engine deposits, both in the combustion chamber and in the engine oil. It may require increased spark plug maintenance and more frequent oil changes. The frequency of spark plug maintenance and oil drain periods will be governed by the amount of lead per gallon and the type of operation. Operation at full rich mixture requires more frequent maintenance periods; therefore it is important to use proper approved mixture leaning procedures.

Reference the latest issue of Lycoming Service Letter No. L185 for care, operation and maintenance of the airplane when using the higher leaded fuel.

THIS PAGE INTENTIONALLY LEFT BLANK

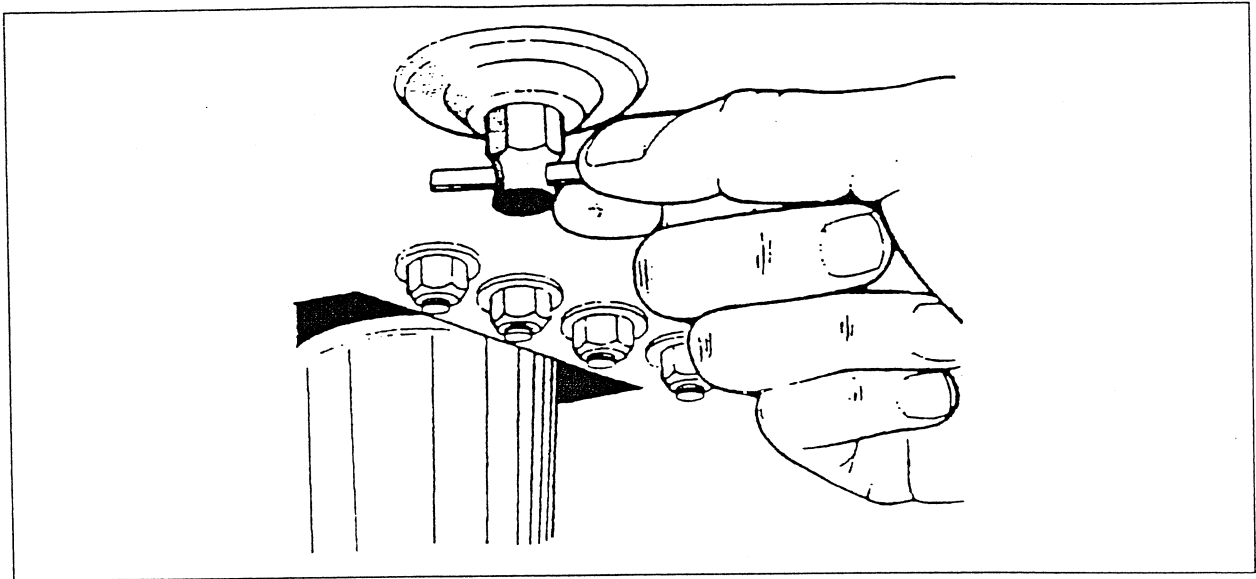

Fuel Drain

A summary of the current grades as well as the previous fuel designations is shown in the following chart:

FUEL GRADE COMPARISON CHART

Previous Commercial Fuel Grades (ASTM-D910)			Current Commercial Fuel Grades (ASTM-D910-75)			Current Military Fuel Grades (MIL-G-5572F)		
Grade	Color	Max. TEL ml/U.S. gal.	Grade	Color	Max. TEL ml/U.S. gal.	Grade	Color	Max. TEL ml/U.S. gal.
80/87	red	0.5	80	red	0.5	80/87	red	0.5
91/96	blue	2.0	*100LL	blue	2.0	none	none	none
100/130	green	3.0	100	green	**3.0	100/130	blue	2.0
115/145	purple	4.6	none	none	none	115/145	purple	4.6

* -Grade 100LL fuel in some over seas countries is colored green and designated as "100L."

** -Commercial fuel grade 100 and grade 100/130 having TEL content of up to 4 ml/U.S. gallons are approved for use in all engines certificated for use with grade 100/130 fuel.

FILLING FUEL TANKS

Observe all required precautions for handling gasoline. Each fuel tank holds a maximum of 25 U.S. gallons. To obtain the standard fuel quantity of 36 U.S. gallons total or 18 gallons per tank, fill the tanks to the bottom of the filler neck tube or visual indicator. To obtain the standard plus reserve quantity, fill the tanks to the top of the filler neck.

DRAINING FUEL VALVES AND LINES

The fuel system should be drained daily prior to first flight and after refueling to avoid the accumulation of water or sediment. Each fuel tank is equipped with an individual quick drain located at the lower inboard rear corner of the tank. The fuel strainer and a quick drain valve are located on the lower left corner of the fire wall. It is important that the fuel system be drained in the following manner:

- a. Open the quick drain valve for a few seconds with the fuel selector valve on one tank. Then change the fuel selector valve to the opposite tank and repeat the procedure. Allow enough fuel to flow out to clear the fuel line as well as the fuel strainer.
- b. Collect the fuel in the container provided for that purpose, and examine the contents for water and sediment. Dispose of contents.
- c. When fuel is flowing clearly, close drain securely, making sure that there is no leakage.

CAUTION

When draining any amount of fuel, care should be taken to ensure that no fire hazard exists before starting engine

DRAINING FUEL SYSTEM

The bulk of the fuel may be drained from the system by opening valve at the inboard end of each fuel tank. Push up on the arms of the drain valve and turn counterclockwise to hold the drain open. The remaining fuel in the system may be drained through the filter bowl. Any individual tank may be drained by closing the selector valve and then draining the desired tank.

CAUTION

Whenever the fuel system is completely drained and fuel is replenished it will be necessary to run the engine for a minimum of 3 minutes at 1000 RPM on each tank to insure no air exists in the fuel supply lines.

TIRE INFLATION

For maximum service from the Cherokee tires, inflate all three to the proper pressure of 24 pounds. If necessary, interchange the tires on the main wheels to produce even wear. All wheels and tires are balanced before original installation, and the relationship of tire, tube and wheel should be maintained if possible. Out of balance wheels can cause extreme vibration on takeoff. In the installation of new components, it may be necessary to rebalance the wheels with the tire mounted.

BATTERY SERVICE

The 12-volt battery is located under the baggage compartment floor. The battery box has a plastic drain tube which should be opened occasionally to drain off any accumulation of liquid. Check the battery for proper fluid level. (Do not fill above the baffle plates.) Use only water - no acid. A hydrometer check should be performed to determine the percent of charge in the battery.

If the battery is not up to charge, charge it before takeoff, as three volts is needed to excite the alternator. Recharge starting at a 4 amp rate and finishing with a 2 amp rate. Quick charges are not recommended.

FACTS YOU SHOULD KNOW

The Federal Aviation Administration (FAA) occasionally publishes Airworthiness Directives (ADs) that apply to specific groups of aircraft. They are mandatory changes and are to be complied with within a time limit set by the FAA. When an AD is issued, it is sent by the FAA to the latest registered owner of the affected aircraft and also to subscribers of their service. Owners should periodically check with their Piper Service Center or Piper's Customer Services Department to see whether they have the latest AD against their airplane. The owner is solely responsible for keeping up with ADs.

Piper Aircraft Corporation takes a continuing interest in having owners get the most efficient use from their airplane and keeping it in the best mechanical condition. Consequently, Piper Aircraft, from time to time, issues service releases including Service Bulletins, Service Letters, Service Spares Letters, and others relating to the airplane.

Piper Service Bulletins are of special importance and Piper considers compliance mandatory. These are sent directly to the latest FAA-registered owners in the United States (U.S.) and Piper Service Centers worldwide. Depending on the nature of the release, material and labor allowances may apply. This information is provided to all authorized Piper Service Centers.

Service Letters deal with product improvements and servicing techniques pertaining to the airplane. They are sent to Piper Service Centers and, if necessary, to the latest FAA-registered owners in the U.S. Owners should give careful attention to Service Letter information.

Service Spares Letters offer improved parts, kits, and optional equipment which were not available originally, and which may be of interest to the owner.

Piper Aircraft Corporation offers a **subscription service** for Service Bulletins, Service Letters, and Service Spares Letters. This service is available to interested persons such as owners, pilots, and mechanics at a nominal fee, and may be obtained through an authorized Piper Service Center or Piper's Customer Services Department.

Service manuals, parts catalogs, and revisions to both, are available from Piper Service Centers or Piper's Customer Services Department. Any correspondence regarding the airplane should include the airplane model and serial number to ensure proper response.

Pilot's Operating Manual supplements are distributed by the manufacturer as necessary. These revisions and additions should be studied and put into the operating manual to keep it up to date. This manual contains important information about the operation of the aircraft and should be kept with the aircraft at all times, even after resale. Every owner, to avail themselves of the latest information concerning their airplane, should stay in close contact with an authorized Piper Service Center or Piper's Customer Services Department.

If the owner desires to have his aircraft modified, he must obtain FAA approval for the alteration. **Major alterations** accomplished in accordance with Advisory Circular 43.13-2, when performed by an A & P mechanic, may be approved by the local FAA office. Major alterations to the basic airframe or systems not covered by AC43.13-2 require a Supplemental Type Certificate.

CHEROKEE CRUISER

The owner or pilot is required to ascertain that the following Aircraft Papers are in order and in the aircraft.

- a. To be displayed in the aircraft at all times:
 1. Aircraft Airworthiness Certificate Form FAA-1362B.
 2. Aircraft Registration Certificate Form FAA-500A.
 3. Aircraft Radio Station License FCC-404A, if transmitters are installed.
- b. To be carried on the aircraft at all times:
 - (1) Aircraft Flight Manual.
 - (2) Weight and Balance Data plus a copy of the latest Repair and Alteration Form FAA-337, if applicable.
 - (3) Aircraft equipment list.

Although the aircraft and engine logbooks are not required to be in the aircraft, they should be made available upon request. Logbooks should be complete and up to date. Good records will reduce maintenance cost by giving the mechanic information about what has or has not been accomplished.

PREVENTIVE MAINTENANCE

The holder of a Pilot Certificate issued under FAR Part 61 may perform certain preventive maintenance described in FAR Part 43. This maintenance may be performed only on an aircraft which the pilot owns or operates and which is not used to carry persons or property for hire, except as provided in applicable FAR's. Although such maintenance is allowed by law, each individual should make a self-analysis as to whether he has the ability to perform the work.

All other maintenance required on the airplane should be accomplished by appropriately licensed personnel.

If maintenance is accomplished, an entry must be made in the appropriate logbook. The entry should contain:

- (a) The date the work was accomplished.
- (b) Description of the work.
- (c) Number of hours on the aircraft.
- (d) The certificate number of pilot performing the work.
- (e) Signature of the individual doing the work.

REQUIRED SERVICE AND INSPECTION PERIODS

The Owner Service Agreement which the owner receives upon delivery of the aircraft should be kept in the aircraft at all times. This identifies him to authorized Piper dealers and entitles the owner to receive service in accordance with the regular service agreement terms. This agreement also entitles the transient owner full warranty by any Piper dealer in the world.

Piper Aircraft Corporation has developed inspection items and required inspection intervals for the PA-28 (see PA-28 Service and Inspection Manuals). The PA-28 Inspection Manual contains appropriate forms, and all inspection procedures should be complied with by a properly trained, knowledgeable, and qualified mechanic at a Piper Authorized Service Center or a reputable repair shop. Piper Aircraft Corporation cannot accept responsibility for the continued airworthiness of any aircraft not maintained to these standards, and/or not brought into compliance with applicable Service Bulletins issued by Piper Aircraft Corporation, instructions issued by the engine, propeller, or accessory manufacturers, or Airworthiness Directives issued by the FAA.

A Programmed Inspection, approved by the Federal Aviation Administration (FAA), is also available to the owner. This involves routine and detailed inspections to allow maximum utilization of the airplane. Maintenance inspection costs are reduced, and the maximum standard of continued airworthiness is maintained. Complete details are available from Piper Aircraft Corporation.

In addition, but in conjunction with the above, the FAA requires periodic inspections on all aircraft to keep the Airworthiness Certificate in effect. The owner is responsible for assuring compliance with these inspection requirements and for maintaining proper documentation in logbooks and/or maintenance records.

A spectrographic analysis of the engine oil is available from several sources. This inspection, if performed properly, provides a good check of the internal condition of the engine. To be accurate, induction air filters must be cleaned or changed regularly, and oil samples must be taken and sent in at regular intervals.

SPECIAL INSTRUCTIONS (cont)

- 8. OVERHEAD TRIM PULLEYS. LUBRICATION MAY BE EXTENDED TO 250 HOURS WHEN DUSTY CONDITIONS ARE AT A MINIMUM.
- 9. AILERON HINGES WITH TEFLON SLEEVES SHOULD NOT BE LUBRICATED. AILERON HINGES WITHOUT TEFLON SLEEVES SHOULD FIRST BE CLEANED WITH A DRY TYPE SOLVENT THEN LUBRICATED WITH MIL-L-7870 LUBRICATING OIL.
- 10. THIS TRANSMISSION TO BE 1/2 FULL OF GREASE. APPLY GREASE DURING ASSEMBLY AND LUBRICATE TRANSMISSION BALL NUT AND SCREW WITH MIL G 23827 GREASE.

NOTES

- 1. PILOT AND PASSENGER SEATS - LUBRICATE TRACK ROLLERS AND STOP PINS AS REQUIRED. (TYPE OF LUBRICANT: A)
- 2. WHEEL BEARINGS REQUIRE CLEANING AND REPACKING AFTER EXPOSURE TO AN ABNORMAL QUANTITY OF WATER.
- 3. FUEL SELECTOR VALVE - LUBRICATE SELECTOR VALVE AS REQUIRED, REFER TO PIPER SERVICE LETTER NO. 351
- 4. SEE LYCOMING SERVICE INSTRUCTIONS NO. 1014 FOR USE OF DETERGENT OIL.

CAUTIONS

- 1. DO NOT USE HYDRAULIC FLUID WITH A CASTOR OIL OR ESTER BASE.
- 2. NO NOT OVER-LUBRICATE COCKPIT CONTROLS.
- 3. DO NOT APPLY LUBRICANT TO RUBBER PARTS.

EXAMPLE

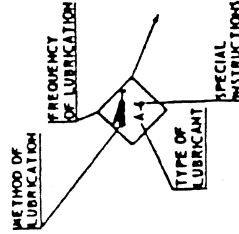

TYPE OF LUBRICANT

PREFERRED PRODUCT AND VENDOR

IDENTIFICATION LETTER	LUBRICANT	SPECIFICATION	PREFERRED PRODUCT AND VENDOR
A	LUBRICATING OIL, GENERAL PURPOSE, LOW TEMP	MIL-L-7870	
B	LUBRICATING OIL, AIRCRAFT RECIPROCATING ENGINE (PISTON) GRADE AS SPECIFIED SAE 50 ABOVE 60°F AIR TEMP. SAE 40 30°F TO 60°F AIR TEMP. SAE 30 01 TO 70°F AIR TEMP. SAE 20 BELOW 10°F AIR TEMP.	MIL-L-6082	
C	HYDRAULIC FLUID	MIL-H-5606	
D	PETROLEUM BASE GREASE, AIRCRAFT AND INSTRUMENT, GEAR AND ACTUATOR SCREW	MIL-G-23827	TEXACO MARFAK ALL PURPOSE GREASE, MOBIL GREASE 77 (OR MOBILUX EP2), SHELL ALVANIA EP GREASE 2
E	GREASE, AIRCRAFT, HIGH TEMP.		
F	PARKER O RING LUBRICANT		FISKE BROS. REFINING CO.
G	AERO LUBRIPLATE		
H	FLUOROCARBON RELEASE AGENT DRY LUBRICANT	*MS-122	
I	GREASE - LUBRICANT GEN PURPOSE AIRCRAFT	MIL-G-7711	

SPECIAL INSTRUCTIONS

- 1. AIR FILTER - TO CLEAN FILTER, TAP GENTLY TO REMOVE DIRT PARTICLES. DO NOT BLOW OUT WITH COMPRESSED AIR OR USE OIL. REPLACE FILTER IF PUNCTURED OR DAMAGED.
- 2. BEARINGS AND BUSHINGS - CLEAN EXTERIOR WITH A DRY TYPE SOLVENT BEFORE LUBRICATING.
- 3. WHEEL BEARINGS - DISASSEMBLE AND CLEAN WITH A DRY TYPE SOLVENT. ASCERTAIN THAT GREASE IS PACKED BETWEEN THE BEARING ROLLER AND CONE. DO NOT PACK GREASE IN WHEEL HOUSING.
- 4. OLEO STRUTS AND BRAKE RESERVOIR - FILL PER INSTRUCTIONS ON UNIT OR CONTAINER, OR REFER TO SERVICE MANUAL, SECTION II
- 5. O RING, CONTROL SHAFT BUSHING (WITH 1.125 INCH SHAFT ONLY), DISASSEMBLE O RING RETAINER PLATES FROM INSTRUMENT PANEL, LUBRICATE O RING AND REASSEMBLE.
- 6. LUBRICATION POINTS - WIPE ALL LUBRICATION POINTS CLEAN OF OLD GREASE, OIL, DIRT, ETC. BEFORE LUBRICATING.
- 7. INTERVALS BETWEEN OIL CHANGES CAN BE INCREASED AS MUCH AS 100% ON ENGINES EQUIPPED WITH FULL FLOW (CARTRIDGE TYPE) OIL FILTERS, PROVIDED THE ELEMENT IS REPLACED EACH 60 HOURS OF OPERATION AND THE SPECIFIED OCTANE FUEL IS USED. SHOULD FUEL OTHER THAN THE SPECIFIED OCTANE RATING FOR THE POWER PLANT BE USED, REFER TO LYCOMING SERVICE LETTER NO. L185A FOR ADDITIONAL INFORMATION AND RECOMMENDED SERVICE PROCEDURES.

Lubrication Nomenclature

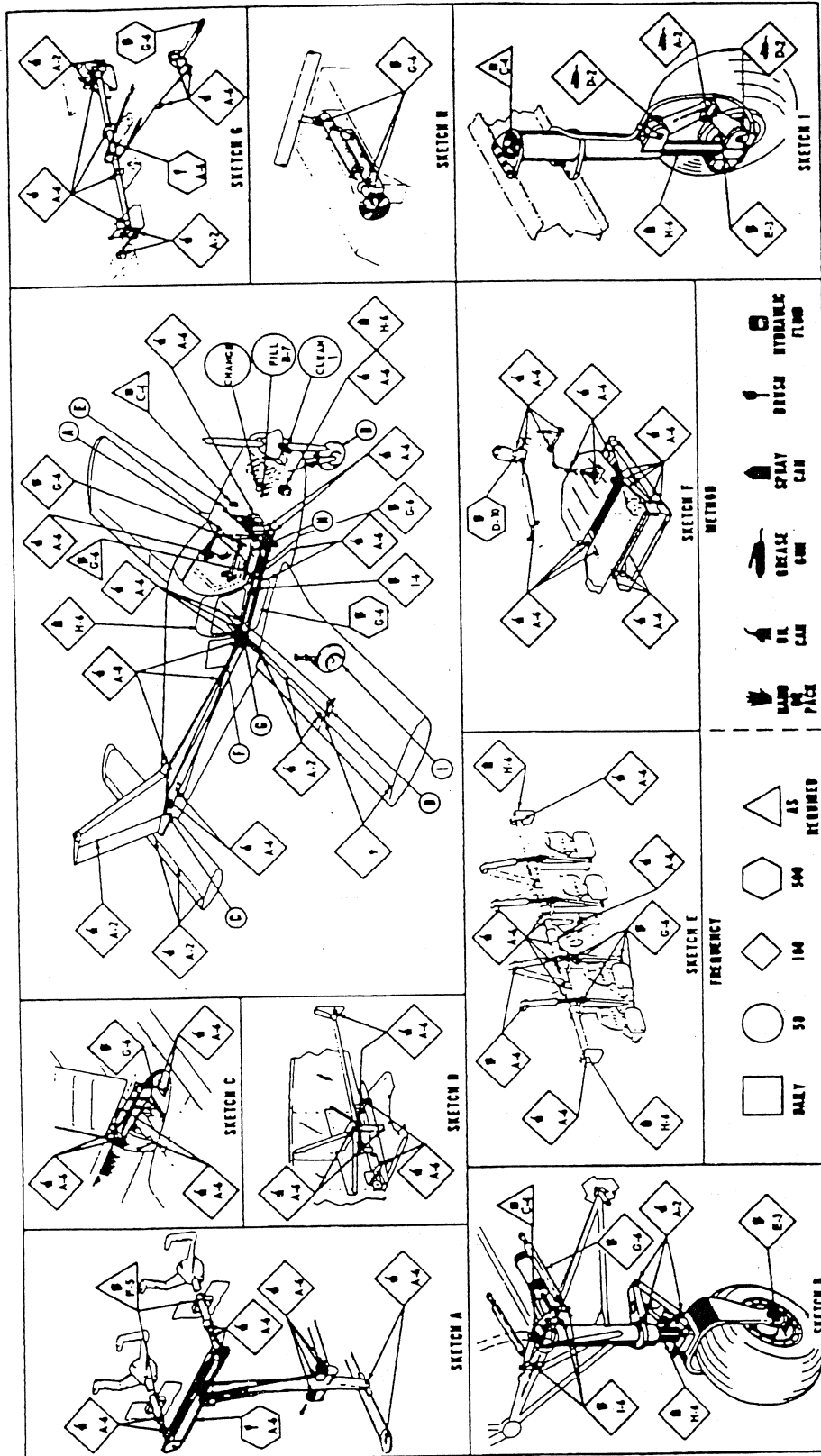

Lubrication Chart

