

PILOT'S OPERATING HANDBOOK

DUPLICATE

PIPER CHEROKEE WARRIOR II



FAA APPROVED IN NORMAL AND UTILITY CATEGORIES BASED ON CAR 3 AND FAR PART 21, SUBPART J. THIS HANDBOOK INCLUDES THE MATERIAL REQUIRED TO BE FURNISHED TO THE PILOT BY CAR 3 AND FAR PART 21, SUBPART J AND CONSTITUTES THE APPROVED AIRPLANE FLIGHT MANUAL AND MUST BE CARRIED IN THE AIRPLANE AT ALL TIMES.

AIRPLANE SERIAL NO. 28-7816422

AIRPLANE REGISTRATION NO. VH-DDK

PA-28-161
REPORT: VB-880

FAA APPROVED BY: Ward Evans
WARD EVANS
D.O.A. NO. SO-1
PIPER AIRCRAFT CORPORATION
VERO BEACH, FLORIDA

DATE OF APPROVAL: DECEMBER 16, 1976



WARNING

EXTREME CARE MUST BE EXERCISED TO LIMIT THE USE OF THIS HANDBOOK TO APPLICABLE AIRCRAFT. THIS HANDBOOK IS VALID FOR USE WITH THE AIRPLANE IDENTIFIED ON THE FACE OF THE TITLE PAGE. SUBSEQUENT REVISIONS SUPPLIED BY PIPER AIRCRAFT CORPORATION MUST BE PROPERLY INSERTED.

Published by
PUBLICATIONS DEPARTMENT
Piper Aircraft Corporation
Issued: December 16, 1976

APPLICABILITY

Application of this handbook is limited to the specific Piper PA-28-161 model airplane designated by serial number and registration number on the face of the title page of this handbook.

This handbook cannot be used for operational purposes unless kept in a current status.

REVISIONS

The information compiled in the Pilot's Operating Handbook will be kept current by revisions distributed to the airplane owners.

Revision material will consist of information necessary to update the text of the present handbook and/or to add information to cover added airplane equipment.

I. Revisions

Revisions will be distributed whenever necessary as complete page replacements or additions and shall be inserted into the handbook in accordance with the instructions given below:

1. Revision pages will replace only pages with the same page number.
2. Insert all additional pages in proper numerical order within each section.
3. Page numbers followed by a small letter shall be inserted in direct sequence with the same common numbered page.

II. Identification of Revised Material

Revised text and illustrations shall be indicated by a black vertical line along the outside margin of the page, opposite revised, added or deleted material. A line along the outside margin of the page opposite the page number will indicate that an entire page was added.

Black lines will indicate only current revisions with changes and additions to or deletions of existing text and illustrations. Changes in capitalization, spelling, punctuation or the physical location of material on a page will not be identified by symbols.



ORIGINAL PAGES ISSUED

The original pages issued for this handbook prior to revision are given below:

Title, ii through v, 1-1 through 1-14, 2-1 through 2-8, 3-1 through 3-12, 4-1 through 4-16, 5-1 through 5-26, 6-1 through 6-56, 7-1 through 7-24, 8-1 through 8-16, 9-1 through 9-10, 10-1 through 10-2.

PILOT'S OPERATING HANDBOOK LOG OF REVISIONS

Current Revisions to the PA-28-161 Cherokee Warrior II Pilot's Operating Handbook, REPORT:-VB-880 issued December 16, 1976.

Revision Number and Code	Revised Pages	Description of Revision	FAA Approval Signature and Date
Rev. 1 - 761 649 (PR770224)	1-6	Corrected to "Meteorological."	 Ward Evans Feb. 24, 1977
	2-5	Revised 2.23.	
	3-11	Revised NOTE.	
	4-4	Revised Starting Engine When Hot procedure.	
	4-9	Revised 4.13 (b).	
	6-4	Revised Leveling Diagram illustration.	
	6-53	Revised Dwg. Nos. of Items 277 and 279.	
	7-24	Added ELT test info.	
Rev. 2 - 761 649 (PR770711)	1-11, 1-12, 1-13, 1-14	Revised para. 1.21, Conversion Factors.	 Ward Evans Feb. 24, 1977
	2-7	In 2.25, revised Takeoff and Landing Checklists to include air cond. info.; added air conditioning warning placard:	
	4-4	Added air cond. check to Ground Check.	
	4-5	Added air cond. directions to Before Takeoff and to Approach and Landing.	
	4-6	Added air cond. directions to Stopping Engine.	
	4-11	Added air cond. check to 4.19, Ground Check.	
	4-12	Added air cond. directions to 4.21, Before Takeoff.	
	4-14	Added air cond. directions to 4.29, Approach and Landing, and 4.31, Stopping Engine.	
	5-3	Revised Fig. nos. in item (b).	
	5-4	Revised Fig. nos. in footnote	
	5-5	Revised Fig. nos. in item (e).	
	5-9	Revised Fig. Nos.; revised Page Nos.; revised titles; added pages; added figures.	
	5-13	Relocated Normal Short Field Takeoff Dist. to 5-14; added new chart.	
	5-14	Relocated Obs. Clearance Short Field Takeoff Dist. to 5-16; added revised chart relocated from 5-13.	
	5-15	Relocated Eng. Perf. to 5-17; added new chart.	
5-16	Relocated Climb Perf. to 5-19; added revised chart relocated from 5-14.		
5-17	Relocated Fuel, Time and Dist. to Climb to 5-20; added chart relocated from 5-15; added ser. nos.		
5-18	Relocated Best Power Cruise Perf. to 5-21; added new chart.		

PILOT'S OPERATING HANDBOOK LOG OF REVISIONS (cont)

Revision Number and Code	Revised Pages	Description of Revision	FAA Approval Signature and Date
Rev. 2 - 761 649 (PR770711) (cont)	5-19	Relocated Best Econ. Cruise Perf. to 5-23; added chart relocated from 5-16.	
	5-20	Relocated Best Power Mix. Range to 5-25; added chart relocated from 5-17.	
	5-21	Relocated Best Econ. Mix. Range to 5-27; added chart relocated from 5-18; added ser. nos.	
	5-22	Relocated Endurance to 5-29; added new chart.	
	5-23	Relocated Fuel, Time and Dist. to Descend to 5-30; added chart relocated from 5-19; added ser. nos.	
	5-24	Relocated Glide Perf. to 5-31; added new chart.	
	5-25	Relocated Landing Perf. to 5-32; added chart relocated from 5-20; added ser. nos.	
	5-26	Added new chart.	
	5-27	Added page; added chart relocated from 5-21; added ser. nos.	
	5-28	Added page (new chart).	
	5-29	Added page (chart relocated from 5-22).	
	5-30	Added page (chart relocated from 5-23).	
	5-31	Added page (chart relocated from 5-24).	
	5-32	Added page (chart relocated from 5-25).	
	6-33	Added items 67 and 69.	
	6-45	Revised item nos.; added item 213.	
	6-46	Revised item nos.; added items 229 through 235; relocated items to following page; added footnote.	
	6-47	Revised item nos.; added items 237 and 253; added relocated items; relocated items to following page; removed footnote.	
	6-48	Added items 259 and 263; added relocated items; added footnote.	
	6-49	Revised item nos.; revised items 273 and 275; added item 281; deleted footnote.	
	6-53	Revised item nos.; added item 325; revised item 329.	
	6-54	Revised item nos.	
	7-i	Added 7.37 to contents.	
7-17	Added climate control panel to Fig. 7-15.		
7-21	Revised air blower info. in 7.23.		
7-24	Added 7.37, Air Conditioning; added footnote.		
7-25, 7-26	Added pages.		
9-i	Added Supplement 4 to contents.		

PILOT'S OPERATING HANDBOOK LOG OF REVISIONS (cont)

Revision Number and Code	Revised Pages	Description of Revision	FAA Approval Signature and Date
Rev. 2 - 761 649 (PR770711) (cont)	9-3	Added STC No. to Section 1 - General; in Section 2 revised (a); in Section 3 revised (a), deleted (c) and renumbered accordingly, revised (c) and (d); added Preflight to Section 4 and relocated material.	<p align="center"><i>Ward Evans</i></p> <p align="center">Ward Evans July 11, 1977</p>
	9-4	Added relocated material; added Inflight heading; revised (a) through (d) and added (e).	
	9-5	Added STC No. to Section 1 - General; in Section 2 revised (a); in Section 3 revised (c) and (d); added (e) and NSD 360 procedures; relocated Section 4.	
	9-6	Added NSD 360 and NSD 360 A procedures; added relocated material; in Section 4 revised (a) (1), added (b) Radio Coupling heading and renumbered (3) and (4) to (b) (1) and (2); relocated material.	
	9-7	Added relocated material; completely revised sections (d) and (e).	
	9-8	Removed item (g).	
	9-11, 9-12, 9 13, 9-14	Added pages (Supplement 4 - Air Conditioning Installation).	
	Rev. 3 - 761 649 (PR780630)	1-4	
2-7		Added new takeoff checklist; revised lead sentence.	
3-3, 3-7		Added info. to Engine Power Loss During Takeoff.	
4-5		Added info. to Before Takeoff	
4-9		Revised items 4.13 (a), (b) and (c).	
4-12		Added info. to Before Takeoff.	
4-13.		Corrected info. under 4.23, Takeoff.	
5-5		Revised item 5.5 (e).	
5-19		Added Note to Figure 5-11.	
5-25		Added Note to Figure-5-19.	
5-26		Added Note to Figure 5-20.	
5-27		Added Note to Figure 5-21.	
5-28		Added Note to Figure 5-22.	
6-1		Revised info. under item 6.1.	
6-9, 6-10	Revised Figure No.		
6-35	Revised item 93; added item 94.		
6-41	Revised items 161 and 163.		
6-43	Revised and added info. to items 179 and 181; relocated info. to pg. 6-44.		
6-44	Added info. from pg. 6-43; added new items 184 and 185; existing item 185 changed to 186; re-located info. to pg. 6-45.		

PILOT'S OPERATING HANDBOOK LOG OF REVISIONS (cont)

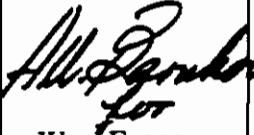
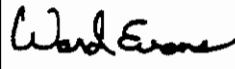
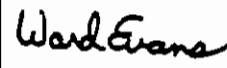
Revision Number and Code	Revised Pages	Description of Revision	FAA Approval Signature and Date
Rev. 3-761649 (PR780630) (cont.)	6-45	Added info. from pg. 6-44; revised item 201; re-located info. to pg. 6-46.	 Ward Evans June 30, 1978
	6-46	Added info. from pg. 6-45; relocated info. to pg. 6-47.	
	6-47	Added info. from pg. 6-46; revised item 235; re-located info. to pg. 6-48.	
	6-48	Added info. from pg. 6-47; revised footnotes.	
	6-49	Revised items 273 and 275.	
	6-54	Revised item 351.	
	7-13	Revised Para. 7.15 info.	
	7-18	Revised Para. 7.21 info.	
	7-21	Added Caution to para. 7.23.	
	7-23	Revised para. 7.35.	
	8-12	Changed 8.21 (d) to (c).	
	8-13	Changed 8.21 (e) to (d).	
	8-i	Revised 8.29.	
	8-16	Revised para. 8.29.	
Rev. 4 - 761 649 (PR790226)	1-6	Revised para. 1.19.	 Ward Evans Feb. 26, 1979
	1-12	Revised para. 1.21.	
	1-13	Revised para. 1.21.	
	6-1	Revised para. 6.1.	
	6-19	Revised item 9.	
	6-33	Added items 71 and 73.	
	6-37	Revised item 113.	
	6-41	Added item 170.	
	7-12	Added Warning to para. 7.15.	
	7-13	Revised para. 7.15.	
7-23	Revised para. 7.35.		
Rev. 5 - 761 649 (PR790413)	6-49	Revised item 277; added item 278.	 Ward Evans April 13, 1979
	7-23	Revised para. 7.35.	
	7-24	Revised para. 7.35; relocated para. 7.37 to pg. 7-25.	
	7-25	Added info. from pg. 7-24.	
Rev. 6 - 761 649 (PR790703)	1-3	Added new engine designation.	
	1-7	Revised item 1.19 (e).	
	2-2	Added new engine designation.	
	2-3	Revised para. 2.11.	
	2-4	Revised para. 2.13.	
	2-7, 2-8	Revised para. 2.25 (revised existing placards, added new placards).	
	3-i	Added para 3.28, Carb. Icing.	
	3-4	Added Carb. Icing.	
	3-11	Added para. 3.28, Carb. Icing.	
	4-1	Added para. 4.28, Descent; revised pg. no.	
4-3	Revised para. 4.5, Preflight Check.		

PILOT'S OPERATING HANDBOOK LOG OF REVISIONS (cont)

Revision Number and Code	Revised Pages	Description of Revision	FAA Approval Signature and Date
Rev. 6 - 761 649 (PR790703) (cont.)	4-4	Revised Before Starting Engine.	
	4-5	Added Descent; relocated Approach and Landing to pg. 4-6.	
	4-6	Added Approach and Landing from pg. 4-5.	
	4-7	Revised para. 4.9.	
	4-8	Revised para. 4.11.	
	4-14	Added para. 4.28, Descent; relocated para. 4.31 to pg. 4-15.	
	4-15	Added para. 4.31 from pg. 4-14.	
	5-3	Revised item 5.5 (a).	
	5-4	Revised item 5.5 (b) and (c).	
	5-5	Revised items 5.5 (d) and (e).	
	5-6	Revised items 5.5 (f) and (g).	
	5-20	Revised Figure 5-13.	
	5-25	Revised Figure 5-19.	
	5-26	Revised Figure 5-20.	
	5-27	Revised Figure 5-21.	
	5-28	Revised Figure 5-22.	
	5-29	Revised Figure 5-23.	
	5-30	Revised Figure 5-25.	
	5-31	Revised Figure 5-27.	
	6-1	Revised para. 6.1.	
	6-3	Added Caution to item 6.3 (a)(3).	
	6-11	Revised Figure 6-9.	
	6-12	Revised Figure 6-11.	
	6-14	Revised Figure 6-15.	
	6-17	Revised para. 6.9; added item 3; revised item 1.	
	6-19	Revised items 5, 7 and 9; added new items.	
	6-21	Revised item nos.; added new items.	
	6-23	Added new items.	
	6-25	Revised item nos.; added new items.	
	6-27	Revised items; added new items.	
	6-29, 6-33,	Revised items.	
	6-35, 6-36		
	6-37	Revised items; added new items.	
	6-38, 6-39	Revised items.	
	6-41, 6-42	Revised items; added item.	
6-43, 6-44,	Revised items; added items.		
6-45, 6-46,			
6-47, 6-48,			
6-49, 6-53,			
6-54			
7-3	Revised para. 7.5.		
7-12	Revised para. 7.15 (added Warning).		
7-16	Revised para. 7.19.		
7-17	Revised Figure 7-15.		
7-20	Revised Figure 7-19.		
8-11	Revised para. 8.19.		
10-1	Revised para. 10.3.		

Ward Evans
Ward Evans
July 3, 1979

PILOT'S OPERATING HANDBOOK LOG OF REVISIONS (cont)

Revision Number and Code	Revised Pages	Description of Revision	FAA Approval Signature and Date
Rev. 7 - 761 649 (PR800530)	1-3	Revised para 1.7.	
	1-4	Revised para. 1.11.	
	2-2	Revised para. 2.7	
	2-4	Revised para. 2.13.	
	2-9	Added page; added to para. 2.25.	
	4-3	Revised para. 4.5.	
	5-5	Revised para. 5.5(d).	
	5-26	Revised fig. 5.20.	
	6-7	Revised fig. 6-5.	
	6-14	Revised fig. 6- 15.	
	6-15	Added para. 6.8.	
	6-16	Added sample problem.	
	6-16a	Added page; cont. sample problem.	
	6-16b	Added page.	
	6-17	Corrected title.	
	6-27	Added to item 39.	
	6-29	Added item 47.	
	6-33	Revised item 67.	
	6-35	Added items 89 thru 91; renumbered items;	
		moved items 94 thru 99 to pg. 6-36.	
	6-36	Relocated items 94 thru 99 from pg. 6-35.	
	6-39	Added item 145, renumbered items.	
	6-40	Added items 151 thru 159.	
	6-42	Added item 176; relocated item 177 from	
		pg. 6-43.	
	6-43	Added item 178; moved item 177 to pg. 6-42.	
	6-44	Added items 196 and 198; renumbered items.	
	6-45	Added item 199; new item 201; renumbered	
		items; moved item 213 to pg. 6-46.	
	6-46	Relocated item 213 from pg. 6-45.	
6-53	Added item 342.		
6-54	Added new items 344 and 345; renumbered items.		
7-i	Added para. 7.39.		
7-21	Revised para. 7.25.		
7-26	Added para. 7.39.		
8-i	Changed page no.		
8-12, 8-13	Revised para. 8.21; moved para. 8.23 to pg. 8-14.		
8-14	Relocated para. 8.23 from pg. 8-13; relocated		
	info. to pg. 8-15.		
8-15, 8-16	Relocated para. 8.27.		
10-2	Added para. (j) to para. 10.3.		

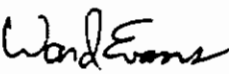
 Ward Evans
 May 30, 1980

PILOT'S OPERATING HANDBOOK LOG OF REVISIONS (cont)

Revision Number and Code	Revised Pages	Description of Revision	FAA Approval Signature and Date
Rev. 8 - 761 649 (PR800814)	9-i 9-15 thru 9-18	Added Supplement 5 and pages. Added Century 21 Autopilot Supplement	<i>Ward Evans</i> Ward Evans August 14, 1980
Rev. 9 - 761 649 (PR801218)	2-2 2-3 3-i 3-4 3-5 3-10 3-11 3-12 6-17 6-23 6-25 6-35 6-38 6-42 6-43 6-49 6-50 7-10 7-12, 7-13 7-14 7-21 9-i 9-15 thru 9-18 9-19 thru 9-20	Revised 2.7 (e). Revised 2.9 (c). Added para. 3.24; change para. title and pg. no. Changed para. title, added info; moved info. to pg. 3-5. Relocated info. from pg. 3-4. Changed para. 3.23, title and contents with info. added; moved para. 3.25 to pg. 3-11. Continued para. 3.23 addition; relocated para. 3.25 from pg. 3-10, moved para. 3.27, 3.28 and 3.29 to pg. 3-12. Relocated para. 3.27, 3.28 and 3.29 from pg. 3-11. Added item 4. Added item 25. Renumbered items. Revised items 90, 91 and 93. Added item 132. Relocated revised item 178 from pg. 6-43. Moved item 178 to pg. 6-42; renumbered item; added new item 181; revised item 182. Added item 276; moved items 281, 283 and 285 to pg. 6-50. Relocated items 281, 283 and 285 from pg. 6-49. Revised para. 7.13. Revised para. 7.15. Revised fig. 7-11. Revised para. 7.25. Added supplement 6 and pages. Retyped supplement 5 Century 21 auto pilot; changed pg. nos. Added supplement 6 Piper Control Wheel Clock Installation.	<i>Ward Evans</i> Ward Evans Dec. 18, 1980

PILOT'S OPERATING HANDBOOK LOG OF REVISIONS (cont)

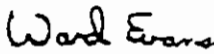
Revision Number and Code	Revised Pages	Description of Revision	FAA Approval Signature and Date
Rev. 10 - 761 649 (PR810629)	ii 1-4 5-1 6-7 6-19 6-27 6-35 6-38 6-41 6-42 6-43 6-45 6-53 6-54 6-55 7-8 7-12	Revised Warning. Revised para. 1.13. Added warning. Revised Figure 6-5. Revised item 11 . Revised items 33, 35 and 39. Revised item 81. Revised item 132. Renumbered items. Renumbered items; added new items 175 and 176. Renumbered items; added new item 183. Revised item 199. Revised item 342. Revised items 343, 344 and 345. Added item 361; removed info. Revised para 7.11 Revised para. 7.15	 Ward Evans June 29, 1981
Rev. 11 - 761 649 (PR8 11120)	2-1 3-1 4-i 4-1 4-3, 4-5, 4-6 4-8 4-12 4-13 4-14 4-15 4-16 6-17 6-19 6-40 6-44 6-45 6-46	Revised para. 2.1. Revised para 3.1 . Amended pg. number. Revised para 4.1 and 4.3. Revised para. 4.5. Added Note to para. 4.9. Added Note to para. 4.21; moved info. to pg. 413. Relocated info. from pg. 4-12; moved info. to pg. 4-14. Relocated info. from pg. 4-13; added Note to para. 4.29; moved info. to pg. 4-15. Relocated info. from pg. 4-14; moved para. 4.35 to pg. 4-16. Relocated para. 4.35 from pg. 4-15. Revised para. 6.9. Revised item 7. Revised item 151. Added new item 184; renumbered existing items 185 thru 1882 moved item 198 to pg. 6-45. Relocated item 198 from pg. 6-44; moved items 209 and 211 to pg. 6-46. Relocated items 209 and 211 from pg. 6-45; moved items 229 and 231 to pg. 6-47.	

PILOT'S OPERATING HANDBOOK LOG OF REVISIONS (cont)



Revision Number and Code	Revised Pages	Description of Revision	FAA Approval Signature and Date
Rev. 11 - 761 649 (PR811120) (cont)	6-47 6-48 6-48 6-55 7-10 7-21 9-20	Relocated items 229 and 231 from pg. 6-46; moved item 247 to pg. 6-48. Relocated item 247 from pg. 6-47. Added new item 277; renumbered items 278 thru 280. Added item 361. Revised para. 7.13. Revised para. 7.25. Corrected spelling errors.	 Ward Evans Nov. 20, 1981
Rev. 12 - 761 649 (PR890417)	3-i 3-1 4-i thru 4-ii 6-7 6-15 7-22 8-1 8-3 8-4 8-11 9-5 9-9	Revised Table of Contents Revised para. 3.1 Revised Table of Contents Revised Figure 6-5. Revised para. 6.8. Revised para. 7.31 Revised para. 8.1 Revised para 8.3 Revised para. 8.5 Revised para. 8.19 and 8.21(b). Revised Section 3 (a) Revised Section 3 (a)	 D.H. Trompler <u>Aug. 23, 1989</u> Date
Rev. 13 - 761 649 (PR900913)	1-3 2-2 7-3 8-4	Revised para. 1.5 (c). Revised para's. 2.7 (j) and (l). Added para. 2.7 (m) and Notes. Revised para. 7.5. Revised para. 8.5.	 D.H. Trompler October 9, 1990

TABLE OF CONTENTS

SECTION 1	GENERAL
SECTION 2	LIMITATIONS
SECTION 3	EMERGENCY PROCEDURES
SECTION 4	NORMAL PROCEDURES
SECTION 5	PERFORMANCE
SECTION 6	WEIGHT AND BALANCE
SECTION 7	DESCRIPTION AND OPERATION OF THE AIRPLANE AND ITS SYSTEMS
SECTION 8	AIRPLANE HANDLING, SERVICING AND MAINTENANCE
SECTION 9	SUPPLEMENTS
SECTION 10	SAFETY TIPS

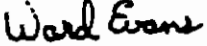
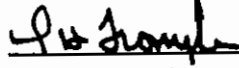
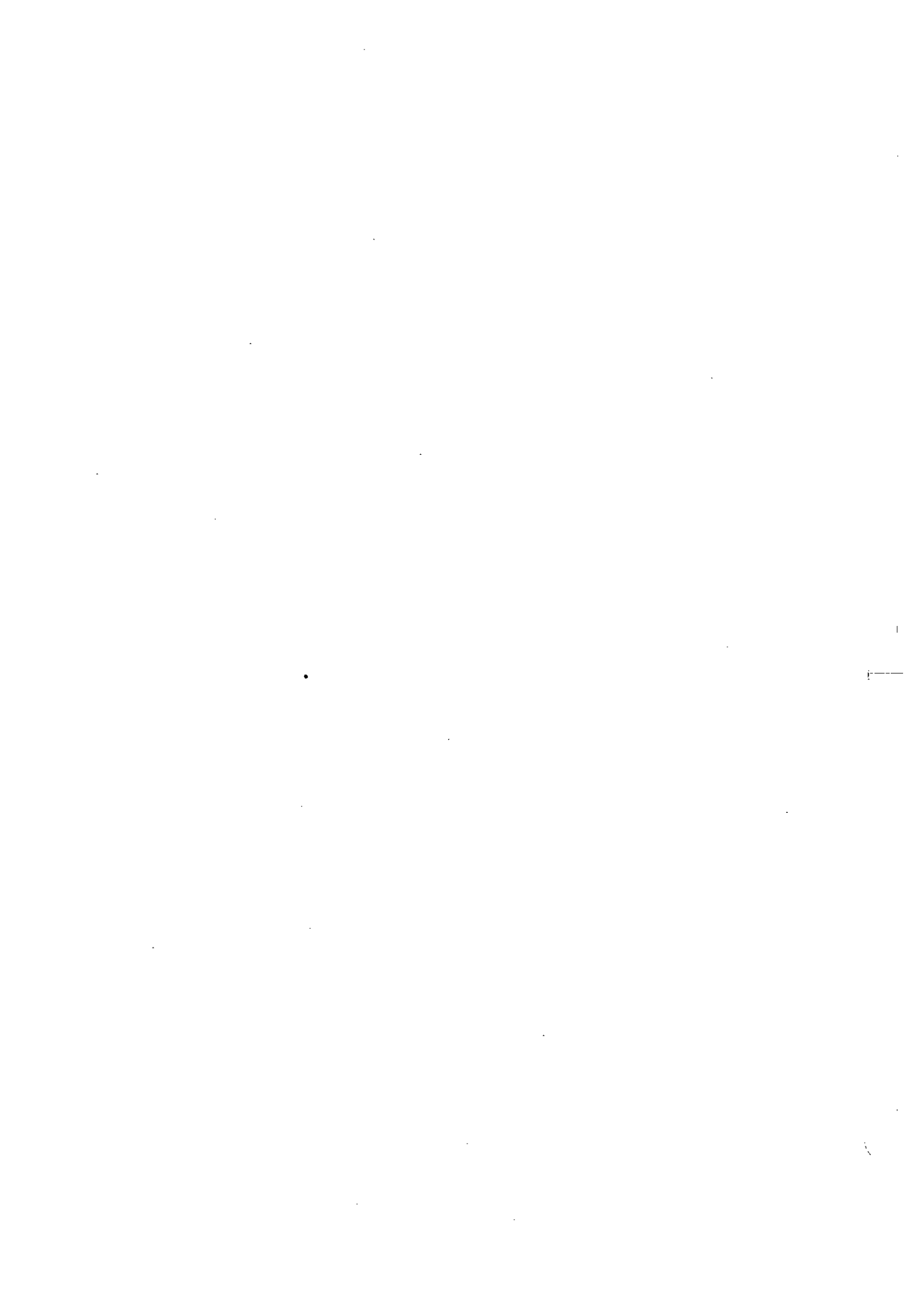

TABLE OF CONTENTS

SECTION 1

GENERAL

Paragraph No.		Page No.
1.1	Introduction.....	1-1
1.3	Engines.....	1-3
1.5	Propellers	1-3
1.7	Fuel	1-3
1.9	Oil	1-3
1.11	Maximum Weights.....	1-4
1.13	Standard Airplane Weights	1-4
1.15	Baggage Space.....	1-4
1.17	Specific Loadings	1-4
1.19	Symbols, Abbreviations and Terminology	1-5
1.21	Conversion Factors	1-11

BLANK PAGE

SECTION 1

GENERAL

1.1 INTRODUCTION

This Pilot's Operating Handbook is designed for maximum utilization as an operating guide for the pilot. It includes the material required to be furnished to the pilot by C.A.R. 3 and FAR Part 21, Subpart J. It also contains supplemental data supplied by the airplane manufacturer.

This handbook is not designed as a substitute for adequate and competent flight instruction, knowledge of current airworthiness directives, applicable federal air regulations or advisory circulars. It is not intended to be a guide for basic flight instruction or a training manual and should not be used for operational purposes unless kept in a current status.

Assurance that the airplane is in an airworthy condition is the responsibility of the owner. The pilot in command is responsible for determining that the airplane is safe for flight. The pilot is also responsible for remaining within the operating limitations as outlined by instrument markings, placards, and this handbook.

Although the arrangement of this handbook is intended to increase its in-flight capabilities, it should not be used solely as an occasional operating reference. The pilot should study the entire handbook to familiarize himself with the limitations, performance, procedures and operational handling characteristics of the airplane before flight.

The handbook has been divided into numbered (arabic) sections, each provided with a "finger-tip" tab divider for quick reference. The limitations and emergency procedures have been placed ahead of the normal procedures, performance and other sections to provide easier access to information that may be required in flight. The "Emergency Procedures" Section has been furnished with a red tab divider to present an instant reference to the section. Provisions for expansion of the handbook have been made by the deliberate omission of certain paragraph numbers, figure numbers, item numbers and pages noted as being left blank intentionally.

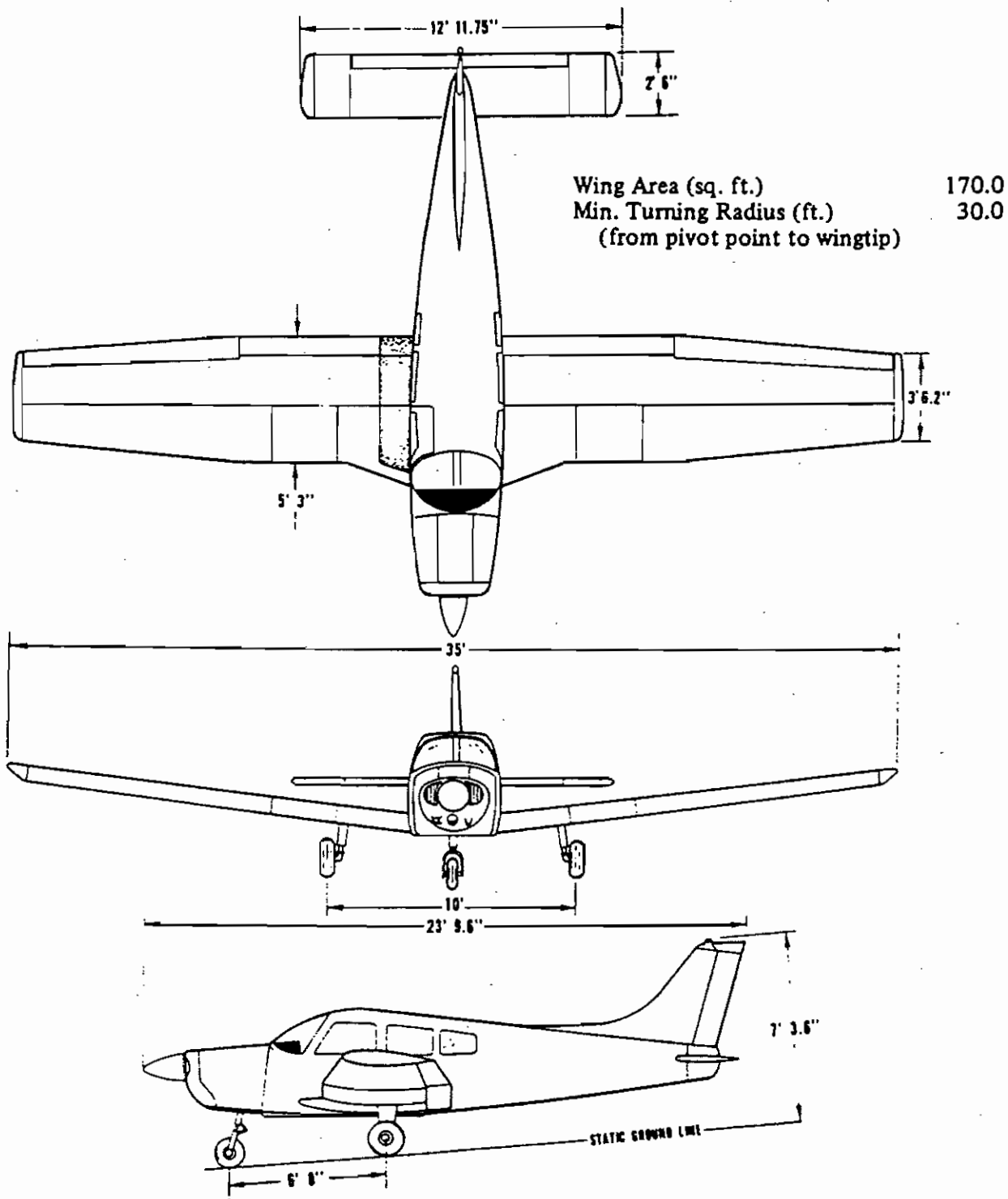

THREE VIEW

Figure 1-1

1.3 ENGINES

(a) Number of Engines	1
(b) Engine Manufacturer	Lycoming
(c) Engine Model Number	0-320-D2A or 0-320-D3G
(d) Rated Horsepower	160
(e) Rated Speed (rpm)	2700
(f) Bore (Inches)	5.125
(g) Stroke (Inches)	3.875
(h) Displacement (cubic inches)	319.8
(i) Compression Ratio	8.5:1
(h) Engine Type	Four Cylinder, Direct Drive, Horizontally Opposed, Air Cooled

1.5 PROPELLERS

(a) Number of Propellers	1
(b) Propeller Manufacturer	Sensenich
(c) Model	74DM6-0-60 or 74DM6-0-58
(d) Number of Blades	2
(e) Propeller Diameter (Inches)	
(1) Maximum	74
(2) Minimum	72
(f) Propeller Type	Fixed Pitch

1.7 FUEL

(a) Fuel Capacity (U.S. gal) (total)-	50
(b) Usable Fuel (U.S. gal) (total)	48
(c) Fuel	
(1) Minimum Octane	100 - Green or 100 LL - Blue Aviation Grade
(2) Alternate Fuel	

Refer to Fuel Requirements,
Section 8 - Handling, Servicing and
Maintenance - paragraph 8.1, Item (b).

1.9 OIL

(a) Oil Capacity (U.S. quarts)	8
(b) Oil Specification	Refer to latest issue of Lycoming Service Instruction 1014.
(c) Oil Viscosity per Average Ambient Temp. for Starting	
	SINGLE MULTI
(1) Above 60°F	S.A.E. 50 S.A.E. 40 or 50
(2) 30°F to 90°F	S.A.E. 40 S.A.E. 40
(3) 0°F to 70°F	S.A.E. 30 S.A.E. 40 or 20W-30
(4) Below 10°F	S.A.E. 20 S.A.E. 20W-30

**SECTION 1
GENERAL**

**PIPER AIRCRAFT CORPORATION
PA-28-161, CHEROKEE WARRIOR II**

1.11 MAXIMUM WEIGHTS

	NORMAL	UTILITY
(a) Maximum Takeoff Weight (lbs)	2325	2020
(b) Maximum Landing Weight (lbs)	2325	2020
(c) Maximum Weights in Baggage Compartment	200	0

1.13 STANDARD AIRPLANE WEIGHTS

Refer to Figure 6-5 for the Standard Empty Weight and the Useful Load.

1.15 BAGGAGE SPACE

(a) Compartment Volume (cubic feet)	24
(b) Entry Width (inches)	22
(c) Entry Height (inches)	20

1.17 SPECIFIC LOADINGS

(a) Wing Loading (lbs per sq ft)	13.7
(b) Power Loading (lbs per hp)	14.5

1.19 SYMBOLS, ABBREVIATIONS AND TERMINOLOGY

The following definitions are of symbols, abbreviations and terminology used throughout the handbook and those which may be of added operational significance to the pilot.

(a) General Airspeed Terminology and Symbols

CAS	Calibrated Airspeed means the indicated speed of an aircraft, corrected for position and instrument error. Calibrated airspeed is equal to true airspeed in standard atmosphere at sea level.
KCAS	Calibrated Airspeed expressed in "Knots."
GS	Ground Speed is the speed of an airplane relative to the ground.
IAS	Indicated Airspeed is the speed of an aircraft as shown on the airspeed indicator when corrected for instrument error. IAS values published in this handbook assume zero instrument error.
KIAS	Indicated Airspeed expressed in "Knots."
M	Mach Number is the ratio of true airspeed to the speed of sound.
TAS	True Airspeed is the airspeed of an airplane relative to undisturbed air which is the CAS corrected for altitude, temperature and compressability.
V _A	Maneuvering Speed is the maximum speed at which application of full available aerodynamic control will not overstress the airplane.
V _{FE}	Maximum Flap Extended Speed is the highest speed permissible with wing flaps in a prescribed extended position.
V _{NE/MNE}	Never Exceed Speed or Mach Number is the speed limit that may not be exceeded at any time.
V _{NO}	Maximum Structural Cruising Speed is the speed that should not be exceeded except in smooth air and then only with caution.
V _S	Stalling Speed or the minimum steady flight speed at which the airplane is controllable.
V _{SO}	Stalling Speed or the minimum steady flight speed at which the airplane is controllable in the landing configuration.
V _X	Best Angle-of-Climb Speed is the airspeed which delivers the greatest gain of altitude in the shortest possible horizontal distance.
V _Y	Best Rate-of-Climb Speed is the airspeed which delivers the greatest gain in altitude in the shortest possible time.

(b) Meteorological Terminology

ISA	International Standard Atmosphere in which: The air is a dry perfect gas; The temperature at sea level is 15° Celsius (59° Fahrenheit); The pressure at sea level is 29.92 inches hg. (1013 mb); The temperature gradient from sea level to the altitude at which the temperature is -56.5°C (-69.7°F) is -0.00198°C (-0.003566°F) per foot and zero above that altitude.
OAT	Outside Air Temperature is the free air static temperature, obtained either from inflight temperature indications or ground meteorological sources, adjusted for instrument error and compressibility effects.
Indicated Pressure Altitude	The number actually read from an altimeter when the barometric subscale has been set to 29.92 inches of mercury (1013 millibars).
Pressure Altitude	Altitude measured from standard sea-level pressure (29.92 in. Hg) by a pressure or barometric altimeter. It is the indicated pressure altitude corrected for position and instrument error. In this handbook, altimeter instrument errors are assumed to be zero.
Station Pressure	Actual atmospheric pressure at field elevation.
Wind	The wind velocities recorded as variables on the charts of this handbook are to be understood as the headwind or tailwind components of the reported winds..

(c) Power Terminology

Takeoff Power	Maximum power permissible for takeoff.
Maximum Continuous Power	Maximum power permissible continuously during flight.
Maximum Climb Power	Maximum power permissible during climb.
Maximum Cruise Power	Maximum power permissible during cruise.

(d) Engine Instruments

EGT Gauge	Exhaust Gas Temperature Gauge
-----------	-------------------------------

(e) Airplane Performance and Flight Planning Terminology

Climb Gradient	The demonstrated ratio of the change in height during a portion of a climb, to the horizontal distance traversed in the same time interval.
Demonstrated Crosswind Velocity WIND)	The demonstrated crosswind velocity is the velocity of the crosswind component for which adequate control of the airplane during takeoff and landing was actually demonstrated during certification tests.
Accelerate-Stop Distance	The distance required to accelerate an airplane to a specified speed and, assuming failure of an engine at the instant that speed is attained, to bring the airplane to a stop.
MEA	Minimum en route IFR altitude.
Route Segment	A part of a route. Each end of that part is identified by: (1) a geographical location; or (2) a point at which a definitive radio fix can be established.

(f) Weight and Balance Terminology

Reference Datum	An imaginary vertical plane from which all horizontal distances are measured for balance purposes.
Station	A location along the airplane fuselage usually given in terms of distance from the reference datum.
Arm	The horizontal distance from the reference datum to the center of gravity (C.G.) of an item.
Moment	The product of the weight of an item multiplied by its arm. (Moment divided by a constant is used to simplify balance calculations by reducing the number of digits.)
Center of Gravity (C.G.)	The point at which an airplane would balance if suspended. Its distance from the reference datum is found by dividing the total moment by the total weight of the airplane.
C.G. Arm	The arm obtained by adding the airplane's individual moments and dividing the sum by the total weight.
C.G. Limits	The extreme center of gravity locations within which the airplane must be operated at a given weight.
Usable Fuel	Fuel available for flight planning.
Unusable Fuel	Fuel remaining after a runout test has been completed in accordance with governmental regulations.
Standard Empty Weight	Weight of a standard airplane including unusable fuel, full operating fluids and full oil.
Basic Empty Weight	Standard empty weight plus optional equipment.
Payload	Weight of occupants, cargo and baggage.
Useful Load	Difference between takeoff weight, or ramp weight if applicable, and basic empty weight.
Maximum Ramp Weight	Maximum weight approved for ground maneuver. (It includes weight of start, taxi and run up fuel.)
Maximum Takeoff Weight	Maximum weight approved for the start of the takeoff run.
Maximum Landing Weight	Maximum weight approved for the landing touchdown.
Maximum Zero Fuel Weight	Maximum weight exclusive of usable fuel.

THIS PAGE INTENTIONALLY LEFT BLANK

THIS PAGE INTENTIONALLY LEFT BLANK

1.21 CONVERSION FACTORS

<u>MULTIPLY</u>	<u>BY</u>	<u>TO OBTAIN</u>	<u>MULTIPLY</u>	<u>BY</u>	<u>TO OBTAIN</u>
acres	0.4047	ha	cubic inches (cu. in.)	16.39	cm ³
	43560	sq. ft.		1.639×10^{-5}	m ³
	0.0015625	sq. mi.		5.787×10^{-4}	cu. ft.
atmospheres (atm)	76	cm Hg	0.5541	fl. oz.	
	29.92	in. Hg	0.01639	1	
	1.0133	bar	4.329×10^{-3}	U.S. gal.	
	1.033	kg/cm ²	0.01732	U.S. qt.	
	14.70	lb./sq. in.	cubic meters (m ³)	61024	cu. in.
	2116	lb./sq. ft.		1.308	cu. yd.
bars (bar)	0.98692	atm.	35.3147	cu. ft.	
	14.503768	lb./sq. in.	264.2	U.S. gal	
British Thermal Unit (BTU)	0.2519958	kg-cal	cubic meters per minute (m ³ /min.)	35.3147	cu. ft./min.
centimeters (cm)	0.3937	in.	cubic yards (cu. yd.)	27	cu. ft.
	0.032808	ft.		0.7646	m ³
centimeters of mercury at 0°C (cm Hg)	0.01316	atm	202	U.S. gal.	
	0.3937	in. Hg	degrees (arc)	0.01745	radians
	0.1934	lb./sq. in.		degrees per second (deg./sec.)	0.01745
	27.85	lb./sq. ft.	drams, fluid (dr. fl.)		0.125
	135.95	kg/m ²		drams, avdp. (dr. avdp.)	0.0625
centimeters per second (cm/sec.)	0.032808	ft./sec.	feet (ft.)	30.48	cm
	1.9685	ft./min.		0.3048	m
	0.02237	mph		12	in.
cubic centimeters (cm ³)	0.03381	fl. oz.	0.33333	yd.	
	0.06102	cu. in.	0.0606061	rod	
	3.531×10^{-5}	cu. ft.	1.894×10^{-4}	mi.	
	0.001	1	1.645×10^{-4}	NM	
	2.642×10^{-4}	U.S. gal.	feet per minute (ft./min.)	0.01136	mph
cubic feet (cu.ft.)	28317	cm ³		0.01829	km/hr.
	0.028317	m ³		0.508	cm/sec.
1728	cu. in.	0.00508		m/sec.	
0.037037	cu. yd.	cubic feet per minute (cu. ft./min.)		0.472	1/sec.
7.481	U.S. gal.		0.028317	m ³ /min.	
28.32	1				

**SECTION 1
GENERAL**

**PIPER AIRCRAFT CORPORATION
PA-28-161, CHEROKEE WARRIOR II**

<u>MULTIPLY</u>	<u>BY</u>	<u>TO OBTAIN</u>	<u>MULTIPLY</u>	<u>BY</u>	<u>TO OBTAIN</u>
feet per second (ft./sec.)	0.6818 1.097 30.48 0.5921	mph km/hr. cm/sec. kts.	hectares (ha)	2.471 107639 10000	acres sq. ft. m ²
foot-pounds (ft.-lb.)	0.138255 3.24 x 10 ⁻⁴	m-kg kg-cal	horsepower (hp)	33000 550 76.04 1.014	ft.-lb./min. ft.-lb./sec. m-kg/sec. metric hp
foot-pounds per minute (ft.-lb./min.)	3.030 x 10 ⁻⁵	hp	horsepower, metric	75 0.9863	m-kg/sec. hp
foot-pounds per second (ft.-lb./sec.)	1.818 x 10 ⁻⁵	hp	inches (in.)	25.40 2.540 0.0254 0.08333 0.027777	mm cm m ft. yd.
gallons, Imperial (Imperial gal.)	277.4 1.201 4.546	cu. in. U.S. gal. 1	inches of mercury at 0°C (in. Hg)	0.033421 0.4912 70.73 345.3 2.540 25.40	atm lb./sq. in. lb./sq. ft. kg/m ² cm Hg mm Hg
gallons, U.S. dry (U.S. gal. dry)	268.8 1.556 x 10 ⁻¹ 1.164 4.405	cu. in. cu. ft. U.S. gal. 1	inch-pounds (in.-lb.)	0.011521	m-kg
gallons, U.S. liquid (U.S. gal.)	231 0.1337 4.951 x 10 ⁻³ 3785.4 3.785 x 10 ⁻³ 3.785 0.83268 128	cu. in. cu. ft. cu. yd. cm ³ m ³ 1 Imperial gal. fl. oz.	kilograms (kg)	2.204622 35.27 1000	lb. oz. avdp. g
gallons per acre (gal./acre)	9.353	l/ha	kilogram-calories (kg-cal)	3.9683 3087 426.9	BTU ft.-lb. m-kg
grams (g)	0.001 0.3527 2.205 x 10 ⁻³	kg oz. avdp. lb.	kilograms per cubic meter (kg/m ³)	0.06243 0.001	lb./cu. ft. g/cm ³
grams per centimeter (g/cm)	0.1 6.721 x 10 ⁻² 5.601 x 10 ⁻³	kg/m lb./ft. lb./in.	kilograms per hectare (kg/ha)	0.892	lb./acre
grams per cubic centimeter (g/cm ³)	1000 0.03613 62.43	kg/m ³ lb./cu. in. lb./cu. ft.	kilograms per square centimeter (kg/cm ²)	0.9678 28.96 14.22 2048	atm in. Hg lb./sq. in. lb./sq. ft.

**PIPER AIRCRAFT CORPORATION
PA-28-161, CHEROKEE WARRIOR II**

**SECTION 1
GENERAL**

<u>MULTIPLY</u>	<u>BY</u>	<u>TO OBTAIN</u>	<u>MULTIPLY</u>	<u>BY</u>	<u>TO OBTAIN</u>
kilograms per square meter (kg/m ²)	2.896 x 10 ⁻³ 1.422 x 10 ⁻³ 0.2048	in. Hg lb./sq. in. lb./sq. ft.	meters per minute (m/min.)	0.06	km/hr.
kilometers (km)	1 x 10 ⁻⁵ 3280.8 0.6214 0.53996	cm ft. mi. NM	meters per second (m/sec.)	3.280840 196.8504 2.237 3.6	ft./sec. ft./min. mph km/hr.
kilometers per hour (km/hr.)	0.9113 58.68 0.53996 0.6214 0.27778 16.67	ft./sec. ft./min. kt mph m/sec. m/min.	microns	3.937 x 10 ⁻⁵	in.
knots (kt)	1 1.689 1.1516 1.852 51.48	nautical mph ft./sec. statute mph km/hr. m/sec.	miles, statute (mi.)	5280 1.6093 1609.3 0.8684	ft. km m NM
liters (l)	1000 61.02 0.03531 33.814 0.264172 0.2200 1.05669	cm ³ cu. in. cu. ft. fl. oz. U.S. gal. Imperial gal. qt.	miles per hour (mph)	44.7041 4.470 x 10 ⁻¹ 1.467 88 1.6093 0.8684	cm/sec. m/sec. ft./sec. ft./min. km/hr. kt
liters per hectare (l/ha)	13.69 0.107	fl. oz./acre gal./acre	miles per hour square (m/hr. sq.)	2.151	ft./sec. sq.
liters per second (l/sec.)	2.12	cu. ft./min.	millibars	2.953 x 10 ⁻²	in. Hg
meters (m)	39.37 3.280840 1.0936 0.198838 6.214 x 10 ⁻⁴ 5.3996 x 10 ⁻⁴	in. ft. yd. rod mi. NM	millimeters (mm)	0.03937	in.
meter-kilogram (m-kg)	7.23301 86.798	ft.-lb. in.-lb.	millimeters of mercury at 0°C (mm Hg)	0.03937	in. Hg
			nautical miles (NM)	6080 1.1516 1852 1.852	ft. statute mi. m km
			ounces, avdp. (oz. avdp.)	28.35 16	g dr. avdp.
			ounces, fluid (fl. oz.)	8 29.57 1.805 0.0296 0.0078	dr. fl. cm ³ cu. in. 1 U.S. gal.

**SECTION 1
GENERAL**

**PIPER AIRCRAFT CORPORATION
PA-28-161, CHEROKEE WARRIOR II**

<u>MULTIPLY</u>	<u>BY</u>	<u>TO OBTAIN</u>	<u>MULTIPLY</u>	<u>BY</u>	<u>TO OBTAIN</u>
ounces, fluid per acre (fl. oz./acre)	0.073	l/ha	rod	16.5 5.5 5.029	ft. yd. m
pounds (lb.)	0.453592 453.6 3.108 x 10 ⁻²	kg g slug	slug	32.174	lb.
pounds per acre (lb./acre)	1.121	kg/ha	square centimeters (cm ²)	0.1550 0.001076	sq. in. sq. ft.
pounds per cubic foot (lb./cu. ft.)	16.02	kg/m ³	square feet (sq. ft.)	929 0.092903 144 0.1111 2.296 x 10 ⁻⁵	cm ² m ² sq. in. sq. yd. acres
pounds per cubic inch (lb./cu. in.)	1728 27.68	lb./cu. ft. g/cm ³	square inches (sq. in.)	6.4516 6.944 x 10 ⁻³	cm ² sq. ft.
pounds per square foot (lb./sq. ft.)	0.1414 4.88243 4.725 x 10 ⁻⁴	in. Hg kg/m ² atm	square kilometers (km ²)	0.3861	sq. mi.
pounds per square inch (psi or lb./sq. in.)	5.1715 2.036 0.06804 0.0689476 703.1	cm Hg in. Hg atm bar kg/m ²	square meters (m ²)	10.76391 1.196 0.0001	sq. ft. sq. yd. ha
quart, U.S. (qt.)	0.94635 57.749	l cu. in.	square miles (sq. mi.)	2.590 640	km ² acres
radians	57.30 0.1592	deg. (arc) rev.	square rods (sq. rods)	30.25	sq. yd.
radians per second (radians/sec.)	57.30 0.1592 9.549	deg./sec. rev./sec. rpm	square yards (sq. yd.)	0.8361 9 0.0330579	m ² sq. ft. sq. rods
revolutions (rev.)	6.283	radians	yards (yd.)	0.9144 3 36 0.181818	m ft. in. rod
revolutions per minute (rpm or rev./min.)	0.1047	radians/sec.			
revolutions per second (rev./sec.)	6.283	radians/sec.			

TABLE OF CONTENTS

SECTION 2

LIMITATIONS

Paragraph No.		Page No.
2.1	General.....	2-1
2.3	Airspeed Limitations.....	2-1
2.5	Airspeed Indicator Markings	2-2
2.7	Power Plant Limitations.....	2-2
2.9	Power Plant Instrument Markings	2-3
2.11	Weight Limits.....	2-3
2.13	Center of Gravity Limits.....	2-4
2.15	Maneuver Limits.....	2-4
2.17	Flight Load Factors	2-4
2.19	Types of Operations	2-5
2.21	Fuel Limitations.....	2-5
2.23	Noise Levels	2-5
2.25	Placards.....	2-7

SECTION 2
LIMITATIONS

2.1 GENERAL

This section provides the "FAA Approved" operating limitations, instrument markings, color coding and basic placards necessary for operation of the airplane and its systems.

This airplane must be operated as a normal or utility category airplane in compliance with the operating limitations stated in the form of placards and markings and those given in this section and handbook.

Limitations associated with those optional systems and equipment which require handbook supplements can be found in Section 9 (Supplements).

2.3 AIRSPEED LIMITATIONS

SPEED	KIAS	KCAS
Never Exceed Speed (VNE) - Do not exceed this speed in any operation.	160	153
Maximum Structural Cruising Speed (VNO) - Do not exceed this speed except in smooth air and then only with caution.	126	122
Design Maneuvering Speed (VA) - Do not make full or abrupt control movements above this speed.		
At 2325 LBS. G.W.	111	108
At 1531 LBS. G.W.	88	89

CAUTION

Maneuvering speed decreases at lighter weight as the effects of aerodynamic forces become more pronounced. Linear interpolation may be used for intermediate gross weights. Maneuvering speed should not be exceeded while operating in rough air.

Maximum Flaps Extended Speed (VFE) - Do not exceed this speed with the flaps extended.	103	100
--	-----	-----

**SECTION 2
LIMITATIONS**

**PIPER AIRCRAFT CORPORATION
PA-28-161, CHEROKEE WARRIOR II**

2.5 AIRSPEED INDICATOR MARKINGS

MARKING	IAS
Red Radial Line (Never Exceed)	160 KTS
Yellow Arc (Caution Range - Smooth Air Only)	126 KTS to 160 KTS
Green Arc (Normal Operating Range)	50 KTS to 126 KTS
White Arc (Flap Down)	44 KTS to 103 KTS

2.7 POWER PLANT LIMITATIONS

(a) Number of Engines	1
(b) Engine Manufacturer	Lycoming
(c) Engine Model No.	0-320-D2A or 0-320-D3G
(d) Engine Operating Limits	
(1) Maximum Horsepower	160
(2) Maximum Rotation Speed (RPM)	2700
(3) Maximum Oil Temperature	245°F
(e) Oil Pressure	
Minimum (red line)	25 PSI
Maximum (red line)	100 PSI
(f) Fuel Pressure	
Minimum (red line)	5 PSI
Maximum (red line)	8 PSI
(g) Fuel (minimum grade)	100 or 100LL Aviation Grade
(h) Number of Propellers	1
(i) Propeller Manufacturer	Sensenich
(j) Propeller Model	74DM6-0-60 or 74DM6-0-58
(k) Propeller Diameter	
Minimum	72 IN.
Maximum	74 IN.
(l) 74DM6-0-60 Propeller Tolerance (static rpm at maximum permissible throttle-setting, Sea Level, ISA)	Not above 2430 RPM Not below 2330 RPM

NOTE

Refer to the airplane maintenance manual for test procedure to determine approved static rpm under non standard conditions.

(m) 74DM6-0-58 Propeller Tolerance (static RPM at maximum permissible throttle setting, Sea Level, ISA)	Not above 2465 RPM Not below 2365 RPM
---	--

NOTE

Refer to the airplane maintenance manual for test procedure to determine approved static rpm under non standard conditions.

2.9 POWER PLANT INSTRUMENT MARKINGS

(a) Tachometer		
Green Arc (Normal Operating Range)		500 to 2700 RPM
Red Line (Maximum Continuous Power)		2700 RPM
(b) Oil Temperature		
Green Arc (Normal Operating Range)		75° to 245°F
Red Line (Maximum)		245°F
(c) Oil Pressure		
Green Arc (Normal Operating Range)		60 PSI to 90 PSI
Yellow Arc (Caution Range) (Idle)		25 PSI to 60 PSI
Yellow Arc (Ground Warm-Up)		90 PSI to 100 PSI
Red Line (Minimum)		25 PSI
Red Line (Maximum)		100 PSI
(d) Fuel Pressure		
Green Arc (Normal Operating Range)		.5 PSI to 8 PSI
Red Line (Minimum)		.5 PSI
Red Line (Maximum)		8 PSI

2.1 WEIGHT LIMITS

	NORMAL	UTILITY
(a) Maximum Weight	2325 LBS	2020 LBS
(b) Maximum Baggage	200 LBS	0 LBS

NOTE

Refer to Section 5 (Performance) for maximum weight as limited by performance.

**SECTION 2
LIMITATIONS**

**PIPER AIRCRAFT CORPORATION
PA-28-161, CHEROKEE WARRIOR II**

2.13 CENTER OF GRAVITY LIMITS

(a) Normal Category

Weight Pounds	Forward Limit Inches Aft of Datum	Rearward Limit Inches Aft of Datum
2325	87.0	93.0
1950 (and less)	83.0	93.0

(b) Utility Category

Weight Pounds	Forward Limit Inches Aft of Datum	Rearward Limit Inches Aft of Datum
1950 (and less)	83.0	93.0
2020	83.8	93.0

NOTES

Straight line variation between points given.

The datum used is 78.4 inches ahead of the wing leading edge at the inboard intersection of the straight and tapered section.

It is the responsibility of the airplane owner and the pilot to insure that the airplane is properly loaded. See Section 6 (Weight and Balance) for proper loading instructions.

2.15 MANEUVER LIMITS

- (a) Normal Category - All acrobatic maneuvers including spins prohibited.
- (b) Utility Category - Approved maneuvers for bank angles exceeding 60°:

	Entry Speed
Steep Turns	111 KIAS
Lazy Eights	111 KIAS
Chandelles	111 KIAS

2.17 FLIGHT LOAD FACTORS

	NORMAL	UTILITY
(a) Positive Load Factor (Maximum)	3.8 G	4.4 G
(b) Negative Load Factor (Maximum)	No inverted maneuvers approved	

2.19 TYPES OF OPERATION

The airplane is approved for the following operations when equipped in accordance with FAR 91 or FAR 135.

- (a) Day V.F.R.
- (b) Night V.F.R.
- (c) Day I.F.R.
- (d) Night I.F.R.
- (e) Non Icing

2.21 FUEL LIMITATIONS

- (a) Total Capacity 50 U.S. GAL
- (b) Unusable Fuel 2 U.S. GAL
The unusable fuel for this airplane has been determined as 1.0 gallon in each wing in critical flight attitudes.
- (c) Usable Fuel 48 U.S. GAL
The usable fuel in this airplane has been determined as 24.0 gallons in each wing.

2.23 NOISE LEVEL

The noise level of this aircraft is 72dBA.

No determination has been made by the Federal Aviation Administration that the noise levels of this airplane are or should be acceptable or unacceptable for operation at, into, or out of, any airport.

The above statement notwithstanding, the noise level stated above has been verified by and approved by the Federal Aviation Administration in noise level test flights conducted in accordance with FAR 36, Noise Standards - Aircraft Type and Airworthiness Certification. This aircraft model is in compliance with all FAR 36 noise standards applicable to this type.

THIS PAGE INTENTIONALLY LEFT BLANK

2.25 PLACARDS

In full view of the pilot:

"THIS AIRPLANE MUST BE OPERATED AS A NORMAL OR UTILITY CATEGORY AIRPLANE IN COMPLIANCE WITH THE OPERATING LIMITATIONS STATED IN THE FORM OF PLACARDS, MARKINGS AND MANUALS.

ALL MARKINGS AND PLACARDS ON THIS AIRPLANE APPLY TO ITS OPERATION AS A UTILITY CATEGORY AIRPLANE. FOR NORMAL AND UTILITY CATEGORY OPERATION, REFER TO THE PILOT'S OPERATING HANDBOOK.

NO ACROBATIC MANEUVERS ARE APPROVED FOR NORMAL CATEGORY OPERATIONS. SPINS ARE PROHIBITED FOR NORMAL AND UTILITY CATEGORY."

In full view of the pilot, one of the following takeoff checklists and one of the following landing check lists will be installed:

TAKEOFF CHECK LIST

Fuel on proper tank
Electric fuel pump on
Engine gauges checked
Flaps - set
Carb heat off

Mixture set
Seat backs erect

Fasten belts/harness
Trim tab - set
Controls - free
Door - latched
Air conditioner - off

TAKEOFF CHECK LIST

Fuel on proper tank
Electric fuel pump-on
Engine gages checked
Flaps - set
Carb. heat off

Mixture set
Primer locked
Seat backs erect

Fasten belts/harness
Trim tab - set
Controls - free
Door - latched
Air conditioner off

LANDING CHECK LIST

Fuel on proper tank
Mixture rich
Electric fuel pump on

Seat backs erect

Flaps - set (103 KIAS max.)
Fasten belts/harness
Air conditioner off

LANDING CHECK LIST

Fuel on proper tank
Mixture rich
Electric fuel pump on

Seat backs erect

Flaps - set (White Arc).
Fasten belts/harness
Air conditioner off

The "AIR COND OFF" item in the above takeoff and landing check lists is mandatory for air conditioned aircraft only.

**SECTION 2
LIMITATIONS**

**PIPER AIRCRAFT CORPORATION
PA-28-161, CHEROKEE WARRIOR II**

In full view of the pilot, in the area of the air conditioner control panel when the air conditioner is installed:

**"WARNING—AIR CONDITIONER MUST BE OFF TO INSURE
NORMAL TAKEOFF CLIMB PERFORMANCE."**

Adjacent to upper door latch:

"ENGAGE LATCH BEFORE FLIGHT."

On inside of the baggage compartment door:

**"BAGGAGE MAXIMUM 200 LBS"
"UTILITY CATEGORY OPERATION - NO BAGGAGE OR AFT
PASSENGERS ALLOWED. NORMAL CATEGORY OPERATION
- SEE PILOT'S OPERATING HANDBOOK WEIGHT AND
BALANCE SECTION FOR BAGGAGE AND AFT PASSENGER
LIMITATIONS."**

In full view of the pilot:

**"MANEUVERING SPEED 111 KIAS AT 2325 LBS. (SEE
P.O.H.)" OR "VA = 111 KIAS AT 2325 #(SEE P.O.H.)"**

**"UTILITY CATEGORY OPERATION - NO AFT PASSENGERS
ALLOWED."**

**"DEMONSTRATED CROSS WIND COMPONENT - 17 KTS." or
"DEMO. X-WIND 17 KTS."**

In full view of the pilot when the oil cooler winterization kit is installed:

**"OIL COOLER WINTERIZATION PLATE TO BE REMOVED
WHEN AMBIENT TEMPERATURE EXCEEDS 50°F."**

In full view of the pilot:

"UTILITY CATEGORY OPERATION ONLY."

- (1) NO AFT PASSENGERS ALLOWED.
- (2) ACROBATIC MANEUVERS ARE LIMITED TO THE FOLLOWING:

	ENTRY SPEED
SPINS PROHIBITED	
STEEP TURNS	111 KIAS
LAZY EIGHTS	111 KIAS
CHANDELLES	111 KIAS

In full view of the pilot:

**"WARNING — TURN OFF STROBE LIGHTS WHEN IN
CLOSE PROXIMITY TO GROUND OR DURING FLIGHT
THROUGH CLOUD, FOG OR HAZE."**

Adjacent to fuel filler caps:

FUEL - 100 OR 100LL AVIATION GRADE

OR

FUEL - 100 AVIATION GRADE MIN.
USABLE CAPACITY 24 GAL.
USABLE CAPACITY TO BOTTOM OF
FILLER NECK INDICATOR 17 GAL.

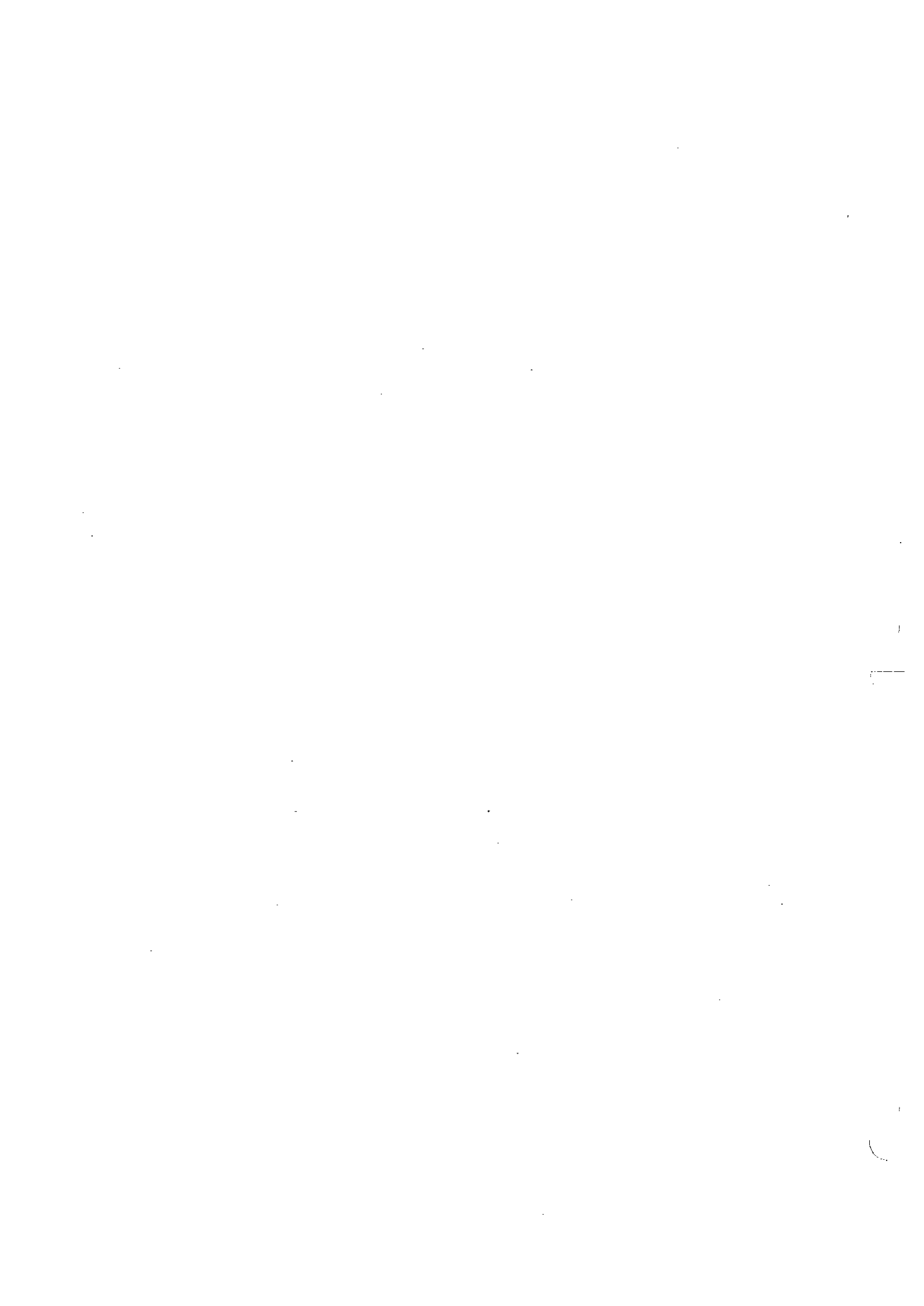

TABLE OF CONTENTS

SECTION 3

EMERGENCY PROCEDURES

Paragraph No.		Page No.
3.1	General	3-1
3.3	Emergency Procedures Check List	3-3
	Engine Fire During Start	3-3
	Engine Power Loss During Takeoff	3-3
	Engine Power Loss On Flight	3-3
	Power Off Landing	3-3
	Fire In Flight.....	3-3
	Loss of Oil Pressure	3-3
	Loss of Fuel Pressure	3-4
	High Oil Temperature.....	3-4
	Electrical Failures.....	3-4
	Electrical Overload.....	3-4
	Spin Recovery	3-4
	Open Door	3-5
	Engine Roughness	3-5
	Carburetor Icing	3-5
3.5	Amplified Emergency Procedures (General)	3-7
3.7	Engine Fire During Start	3-7
3.9	Engine Power Loss During Takeoff	3-7
3.11	Engine Power Loss In Flight.....	3-8
3.13	Power Off Landing.....	3-8
3.15	Fire In Flight	3-9
3.17	Loss of Oil Pressure	3-9
3.19	Loss of Fuel Pressure	3-10
3.21	High Oil Temperature	3-10
3.23	Electrical Failures	3-10
3.24	Electrical Overload	3-10
3.25	Spin Recovery	3-11
3.27	Open Door.....	3-12
3.28	Carburetor Icing	3-12
3.29	Engine Roughness.....	3-12

BLANK PAGE

**SECTION 3
EMERGENCY PROCEDURES**

3.1 GENERAL

This section provides the recommended procedures for coping with various emergency or critical situations. All of the emergency procedures required by the FAA as well as those necessary for operation of the airplane, as determined by the operating and design features of the airplane, are presented.

Emergency procedures associated with optional systems and equipment which require handbook supplements are presented in Section 9, Supplements.

This section is divided into two basic parts. The first part contains the emergency procedures checklists. These checklists supply an immediate action sequence to be followed during critical situations with little emphasis on the operation of the systems.

The second part of the section provides amplified emergency procedures corresponding to the emergency procedures checklist items. These amplified emergency procedures contain additional information to provide the pilot with a more complete description of the procedures so they may be more easily understood.

Pilots must familiarize themselves with the procedures given in this section and must be prepared to take the appropriate action should an emergency situation arise. The procedures are offered as a course of action for coping with the particular situation or condition described. They are not a substitute for sound judgement and common sense.

Most basic emergency procedures are a normal part of pilot training. The information presented in this section is not intended to replace this training. This information is intended to provide a source of reference for the procedures which are applicable to this airplane. The pilot should review standard emergency procedures periodically to remain proficient in them.

THIS PAGE INTENTIONALLY LEFT BLANK

3.3 EMERGENCY PROCEDURES CHECK LIST

ENGINE FIRE DURING START

Startercrank engine
Mixtureidle cut-off
Throttleopen
Electric fuel pump.....OFF
Fuel selector.....OFF
Abandon if fire continues

ENGINE POWER LOSS DURING TAKEOFF

If sufficient runway remains for a normal landing,
land straight ahead.

If insufficient runway remains:

Maintain safe airspeed
Make only shallow turn to avoid obstructions
Flaps as situation requires

If sufficient altitude has been gained to attempt a
restart:

Maintain safe airspeed
Fuel selector.....switch to tank
containing fuel
Electric fuel pumpcheck ON
Mixturecheck RICH
Carburetor heat.....ON
Primerlocked
If power is not regained, proceed with power off
landing.

ENGINE POWER LOSS IN FLIGHT

Fuel selector.....switch to tank
containing fuel
Electric fuel pumpON
MixtureRICH
Carburetor heat.....ON
Engine gaugescheck for indication
of cause of power loss
Primer.....check locked
If no fuel pressure is indicated, check tank selector
position to be sure it is on a tank containing fuel.

When power is restored:

Carburetor heatOFF
Electric fuel pump.....OFF

If power is not restored prepare for power off
landing.
Trim for 73 KIAS

POWER OFF LANDING

Locate suitable field.
Establish spiral pattern.
1000 ft. above field at downwind position for
normal landing approach.
When field can easily be reached slow to 63 KIAS
for shortest landing.

Touchdowns should normally be made at lowest
possible airspeed with full flaps.

When committed to landing:

Ignition.....OFF
Master switch.....OFF
Fuel selector.....OFF
Mixtureidle cut-off
Seat belt and harness.....tight

FIRE IN FLIGHT

Source of firecheck

Electrical fire (smoke in cabin):

Master switch.....OFF
Ventsopen
Cabin heatOFF
Land as soon as practicable.

Engine fire:

Fuel selector.....OFF
ThrottleCLOSED
Mixtureidle cut-off
Electric fuel pumpcheck OFF
Heater.....OFF
DefrosterOFF
Proceed with POWER OFF LANDING procedure.

LOSS OF OIL PRESSURE

Land as soon as possible and investigate cause.
Prepare for power off landing.

LOSS OF FUEL PRESSURE

Electric fuel pumpON
Fuel selectorcheck on full tank

HIGH OIL TEMPERATURE

Land at nearest airport and investigate the problem.
Prepare for power off landing.

ELECTRICAL FAILURES

ALT annunciator light illuminated:
Ammeter.....Check to verify inop. alt.

If ammeter shows zero:
ALT switchOFF

Reduce electrical loads to minimum:
ALT circuit breaker.....Check and reset
as required
ALT switchON

If power not restored:
ALT switchOFF

If alternator output cannot be restored, reduce electrical loads and land as soon as practical. The battery is the only remaining source of electrical power.

ELECTRICAL OVERLOAD (Alternator over 20 amps above known electrical load)

FOR AIRPLANES WITH INTERLOCKED BAT AND ALT SWITCH OPERATION.

Electrical loadReduce

If alternator loads are reduced:
ALT switchOFF

Land as soon as practical. Battery is the only remaining source of power. Anticipate complete electrical failure.

ELECTRICAL OVERLOAD (Alternator over 20 amps above known electrical load)

FOR AIRPLANES WITH SEPARATE BAT AND ALT SWITCH OPERATION

ALT switchON
BATT switchOFF

If alternator loads are reduced:
Electrical loadReduce to Minimum

Land as soon as practical.

NOTE

Due to increased system voltage and radio frequency noise, operation with ALT switch ON and BATT switch OFF should be made only when required by an electrical system failure.

If alternator loads are not reduced:
ALT switchOFF
BATT switchAs required

Land as soon as possible. Anticipate complete electrical failure.

SPIN RECOVERY

Throttle.....idle
Ailerons.....neutral
Rudder.....full opposite to
direction of rotation
Control wheel.....full forward
Rudder.....neutral (when
rotation stops)
Control wheelas required to smoothly
regain level flight altitude

OPEN DOOR

If both upper and lower latches are open, the door will trail slightly open and airspeeds will be reduced slightly.

To close the door in flight:

Slow airplane to 89 KIAS

Cabin vents.....close

Storm window.....open

If upper latch is open.....latch

If side latch is open.....pull on arm rest while
moving latch handle to
latched position.

If both latches are openlatch side latch
then top latch

ENGINE ROUGHNESS

Carburetor heatON

If roughness continues after one min:

Carburetor heatOFF

Mixtureadjust for max.
smoothness

Electric fuel pump.....ON

Fuel selector.....switch tanks

Engine gauges.....check

Magneto switch“L” then “R”
then “BOTH”

If operation is satisfactory on either one, continue on that magneto at reduced power and full “RICH” mixture to first airport.

Prepare for power off landing.

CARBURETOR ICING

Carburetor heatON

Mixtureadjust for max.
smoothness

THIS PAGE INTENTIONALLY LEFT BLANK

3.5 AMPLIFIED EMERGENCY PROCEDURES (GENERAL)

The following paragraphs are presented to supply additional information for the purpose of providing the pilot with a more complete understanding of the recommended course of action and probable cause of an emergency situation.

3.7 ENGINE FIRE DURING START

Engine fires during start are usually the result of overpriming. The first attempt to extinguish the fire is to try to start the engine and draw the excess fuel back into the induction system.

If a fire is present before the engine has started, move the mixture control to idle cut-off, open the throttle and crank the engine. This is an attempt to draw the fire back into the engine.

If the engine has started, continue operating to try to pull the fire into the engine.

In either case (above), if fire continues more than a few seconds, the fire should be extinguished by the best available external means.

The fuel selector valves should be "OFF" and the mixture at idle cut-off if an external fire extinguishing method is to be used.

3.9 ENGINE POWER LOSS DURING TAKEOFF

The proper action to be taken if loss of power occurs during takeoff will depend on the circumstances of the particular situation.

If sufficient runway remains to complete a normal landing, land straight ahead.

If insufficient runway remains, maintain a safe airspeed and make only a shallow turn if necessary to avoid obstructions. Use of flaps depends on the circumstances. Normally, flaps should be fully extended for touchdown.

If sufficient altitude has been gained to attempt a restart, maintain a safe airspeed and switch the fuel selector to another tank containing fuel. Check the electric fuel pump to insure that it is "ON" and that the mixture is "RICH." The carburetor heat should be "ON" and the primer locked.

If engine failure was caused by fuel exhaustion, power will not be regained after switching fuel tanks until the empty fuel lines are filled. This may require up to ten seconds.

If power is not regained, proceed with the Power Off Landing procedure (refer to the emergency check list and paragraph 3.13).

3.11 ENGINE POWER LOSS IN FLIGHT

Complete engine power loss is usually caused by fuel flow interruption and power will be restored shortly after fuel flow is restored. If power loss occurs at a low altitude, the first step is to prepare for an emergency landing (refer to paragraph 3.13). An airspeed of at least 73 KIAS should be maintained.

If altitude permits, switch the fuel selector to another tank containing fuel and turn the electric fuel pump "ON." Move the mixture control to "RICH" and the carburetor heat to "ON." Check the engine gauges for an indication of the cause of the power loss. Check to insure the primer is locked. If no fuel pressure is indicated, check the tank selector position to be sure it is on a tank containing fuel.

When power is restored move the carburetor heat to the "OFF" position and turn "OFF" the electric fuel pump.

If the preceding steps do not restore power, prepare for an emergency landing.

If time permits, turn the ignition switch to "L" then to "R" then back to "BOTH." Move the throttle and mixture control levers to different settings. This may restore power if the problem is too rich or too lean a mixture or if there is a partial fuel system restriction. Try other fuel tanks. Water in the fuel could take some time to be used up, and allowing the engine to windmill may restore power. If power loss is due to water, fuel pressure indications will be normal.

If engine failure was caused by fuel exhaustion power will not be restored after switching fuel tanks until the empty fuel lines are filled. This may require up to ten seconds.

If power is not regained, proceed with the Power Off Landing procedure (refer to the emergency check list and paragraph 3.13).

3.13 POWER OFF LANDING

If loss of power occurs at altitude, trim the aircraft for best gliding angle (73 KIAS) and look for a suitable field. If measures taken to restore power are not effective, and if time permits, check your charts for airports in the immediate vicinity; it may be possible to land at one if you have sufficient altitude. If possible, notify the FAA by radio of your difficulty and intentions. If another pilot or passenger is aboard, let him help.

When you have located a suitable field, establish a spiral pattern around this field. Try to be at 1000 feet above the field at the downwind position, to make a normal landing approach. When the field can easily be reached, slow to 63 KIAS for the shortest landing. Excess altitude may be lost by widening your pattern, using flaps or slipping, or a combination of these.

Touchdown should normally be made at the lowest possible airspeed.

When committed to a landing shut "OFF" the master and ignition switches. Flaps may be used as desired. Turn the fuel selector valve to "OFF" and move the mixture to idle cut-off. The seat belts and shoulder harness should be tightened. Touchdown should be normally made at the lowest possible airspeed.

3.15 FIRE IN FLIGHT

The presence of fire is noted through smoke, smell and heat in the cabin. It is essential that the source of the fire be promptly identified through instrument readings, character of the smoke, or other indications since the action to be taken differs somewhat in each case.

Check for the source of the fire first.

If an electrical fire is indicated (smoke in the cabin), the master switch should be turned "OFF." The cabin vents should be opened and the cabin heat turned "OFF." A landing should be made as soon as possible.

If an engine fire is present, switch the fuel selector to "OFF" and close the throttle. The mixture should be at idle cut-off. Turn the electric- fuel pump "OFF." In all cases, the heater and defroster should be "OFF." If radio communication is not required, select master switch "OFF." Proceed with power off landing procedure.

NOTE

The possibility of an engine fire in flight is extremely remote. The procedure given is general and pilot judgment should be the determining factor for action in such an emergency.

3.17 LOSS OF OIL PRESSURE

Loss of oil pressure may be either partial or complete. A partial loss of oil pressure usually indicates a malfunction in the oil pressure regulating system, and a landing should be made as soon as possible to investigate the cause and prevent engine damage.

A complete loss of oil pressure indication may signify oil exhaustion or may be the result of a faulty gauge. In either case, proceed toward the nearest airport, and be prepared for a forced landing. If the problem is not a pressure gauge malfunction, the engine may stop suddenly. Maintain altitude until such time as a dead stick landing can be accomplished. Don't change power settings unnecessarily, as this may hasten complete power loss.

Depending on the circumstances, it may be advisable to make an off airport landing while power is still available, particularly if other indications of actual oil pressure loss, such as sudden increases in temperatures, or oil smoke, are apparent, and an airport is not close.

If engine stoppage occurs, proceed with Power Off Landing.

3.19 LOSS OF FUEL PRESSURE

If loss of fuel pressure occurs, turn "ON" the electric fuel pump and check that the fuel selector is on a full tank.

If the problem is not an empty tank, land as soon as practical and have the engine-driven fuel pump and fuel system checked.

3.21 HIGH OIL TEMPERATURE

An abnormally high oil temperature indication may be caused by a low oil level, an obstruction in the oil cooler, damaged or improper baffle seals, a defective gauge, or other causes. Land as soon as practical at an appropriate airport and have the cause investigated.

A steady, rapid rise in oil temperature is a sign of trouble. Land at the nearest airport and let a mechanic investigate the problem. Watch the oil pressure gauge for an accompanying loss of pressure.

3.23 ELECTRICAL FAILURES

Loss of alternator output is detected through zero reading on the ammeter. Before executing the following procedure, insure that the reading is zero and not merely low by actuating an electrically powered device, such as the landing light. If no increase in the ammeter reading is noted, alternator failure can be assumed.

The electrical load should be reduced as much as possible. Check the alternator circuit breakers for a popped circuit.

The next step is to attempt to reset the overvoltage relay. This is accomplished by moving the ALT switch to OFF for one second and then to ON. If the trouble was caused by a momentary overvoltage condition (16.5 volts and up) this procedure should return the ammeter to a normal reading.

If the ammeter continues to indicate "O" output, or if the alternator will not remain reset turn off the ALT switch, maintain minimum electrical load and land as soon as practical. All electrical load is being supplied by the battery.

3.24 ELECTRICAL OVERLOAD (Alternator over 20 amps above known electrical load)

If abnormally high alternator output is observed (more than 20 amps above known electrical load for the operating conditions) it may be caused by a low battery, a battery fault or other abnormal electrical load. If the cause is a low battery, the indication should begin to decrease toward normal within 5 minutes. If the overload condition persists attempt to reduce the load by turning off non-essential equipment. For airplanes with interlocked BATT and ALT switch operation, when the electrical load cannot be reduced turn the ALT switch OFF and land as soon as practical. The battery is the only remaining source of electrical power. Also anticipate complete electrical failure.

For airplanes with separate BATT and ALT switch operations, turn the BATT switch OFF and the ammeter should decrease. Turn the BATT switch ON and continue to monitor the ammeter. If the alternator output does not decrease within 5 minutes, turn the BATT switch OFF and land as soon as practical. All electrical loads are being supplied by the alternator.

NOTE

Due to higher voltage and radio frequency noise, operation with the ALT switch ON and the BATT switch OFF should be made only when required by an electrical failure.

3.25 SPIN RECOVERY

Intentional spins are prohibited in this airplane. If a spin is inadvertently entered, immediately move the throttle to idle and the ailerons to neutral.

Full rudder should then be applied opposite to the direction of rotation followed by control wheel full forward. When the rotation stops, neutralize the rudder and ease back on the control wheel as required to smoothly regain a level flight attitude.

3.27 OPEN DOOR

The cabin door on the Cherokee is double latched, so the chances of its springing open in flight at both the top and side are remote. However, should you forget the upper latch, or not fully engage the side latch, the door may spring partially open. This will usually happen at takeoff or soon afterward. A partially open door will not affect normal flight characteristics, and a normal landing can be made with the door open.

If both upper and side latches are open, the door will trail slightly open, and airspeed will be reduced slightly.

To close the door in flight, slow the airplane to 89 KIAS, close the cabin vents and open the storm window. If the top latch is open, latch it. If the side latch is open, pull on the arm rest while moving the latch handle to the latched position. If both latches are open, close the side latch then the top latch.

3.28 CARBURETOR ICING

Under certain moist atmospheric conditions at temperatures of -5°C to 20°C , it is possible for ice to form in the induction system, even in summer weather. This is due to the high air velocity through the carburetor venturi and the absorption of heat from this air by vaporization of the fuel.

To avoid this, carburetor preheat is provided to replace the heat lost by vaporization. Carburetor heat should be full on when carburetor ice is encountered. Adjust mixture for maximum smoothness.

3.29 ENGINE ROUGHNESS

Engine roughness is usually due to carburetor icing which is indicated by a drop in RPM, and may be accompanied by a slight loss of airspeed or altitude. If too much ice is allowed to accumulate, restoration of full power may not be possible; therefore, prompt action is required.

Turn carburetor heat on (See Note). RPM will decrease slightly and roughness will increase. Wait for a decrease in engine roughness or an increase in RPM, indicating ice removal. If no change in approximately one minute, return the carburetor heat to "OFF."

If the engine is still rough, adjust the mixture for maximum smoothness. The engine will run rough if too rich or too lean. The electric fuel pump should be switched to "ON" and the fuel selector switched to the other tank to see if fuel contamination is the problem. Check the engine gauges for abnormal readings. If any gauge readings are abnormal, proceed accordingly. Move the magneto switch to "L" then to "R," then back to "BOTH." If operation is satisfactory on either magneto, proceed on that magneto at reduced power, with mixture full "RICH," to a landing at the first available airport.

If roughness persists, prepare for a precautionary landing at pilot's discretion.

NOTE

Partial carburetor heat may be worse than no heat at all, since it may melt part of the ice, which will refreeze in the intake system. When using carburetor heat, therefore, always use full heat, and when ice is removed return the control to the full cold position.

TABLE OF CONTENTS

SECTION 4

NORMAL PROCEDURES

Paragraph No.		Page No.
4.1	General.....	4-1
4.3	Airspeed for Safe Operation	4-1
4.5	Normal Procedures Check List	4-3
	Preflight Check.....	4-3
	Before Starting Engine	4-4
	Starting Engine When Cold.....	4-4
	Starting Engine When Hot	4-4
	Starting Engine When Flooded	4-4
	Starting With External Power Source.....	4-4
	Warm-Up	4-4
	Taxiing	4-4
	Ground Check	4-4
	Before Takeoff.....	4-5
	Takeoff.....	4-5
	Climb.....	4-5
	Cruising	4-5
	Descent	4-5
	Approach and Landing	4-6
	Stopping Engine	4-6
	Parking	4-6
4.7	Amplified Normal Procedures (General)	4-7
4.9	Preflight Check	4-7
4.11	Before Starting Engine.....	4-8
4.13	Starting Engine.....	4-9
4.15	Warm-Up.....	4-11
4.17	Taxiing.....	4-11
4.19	Ground Check	4-11
4.21	Before Takeoff	4-12
4.23	Takeoff	4-12
4.25	Climb.....	4-13
4.27	Cruising.....	4-13
4.28	Descent.....	4-14
4.29	Approach and Landing	4-14

TABLE OF CONTENTS

SECTION 4

NORMAL PROCEDURES

(Continued)

Paragraph No.		Page No.
4.31	Stopping Engine.....	4-15
4.33	Parking	4-15
4.35	Stalls	4-16
4.37	Turbulent Air Operation.....	4-16
4.39	Weight and Balance.....	4-16

**SECTION 4
NORMAL PROCEDURES**

4.1 GENERAL

This section describes the recommended procedures for the conduct of normal operations for the Cherokee Warrior II. All of the required (FAA regulations) procedures and those necessary for operation of the airplane as determined by the operating and design features of the airplane are presented.

Normal procedures associated with those optional systems and equipment which require handbook supplements are provided by Section 9 (Supplements).

These procedures are provided to present a source of reference and review and to supply information on procedures which are not the same for all aircraft. Pilots should familiarize themselves with the procedures given in this section in order to become proficient in the normal operations of the airplane.

The first portion of this section consists of a short form check list which supplies an action sequence for normal operations with little emphasis on the operation of the systems.

The remainder of the section is devoted to amplified normal procedures which provide detailed information and explanations of the procedures and how to perform them. This portion of the section is not intended for use as an in-flight reference due to the lengthy explanations. The short form check list should be used for this purpose.

4.3 AIRSPEEDS FOR SAFE OPERATIONS

The following airspeeds are those which are significant to operation of the airplane. These figures are for standard airplanes flown at gross weight under standard conditions at sea level.

Performance for a specific airplane may vary from published figures depending upon the equipment installed, the condition of the engine, airplane and equipment, atmospheric conditions and piloting technique.

(a) Best Rate of Climb Speed	79 KIAS
(b) Best Angle of Climb Speed	63 KIAS
(c) Turbulent Air Operating Speed (See Subsection 2.3)	111 KIAS
(d) Maximum Flap Speed	103 KIAS
(e) Landing Final Approach Speed (Flaps 40°)	63 KIAS
(f) Maximum Demonstrated Crosswind Velocity	17 KTS

THIS PAGE INTENTIONALLY LEFT BLANK

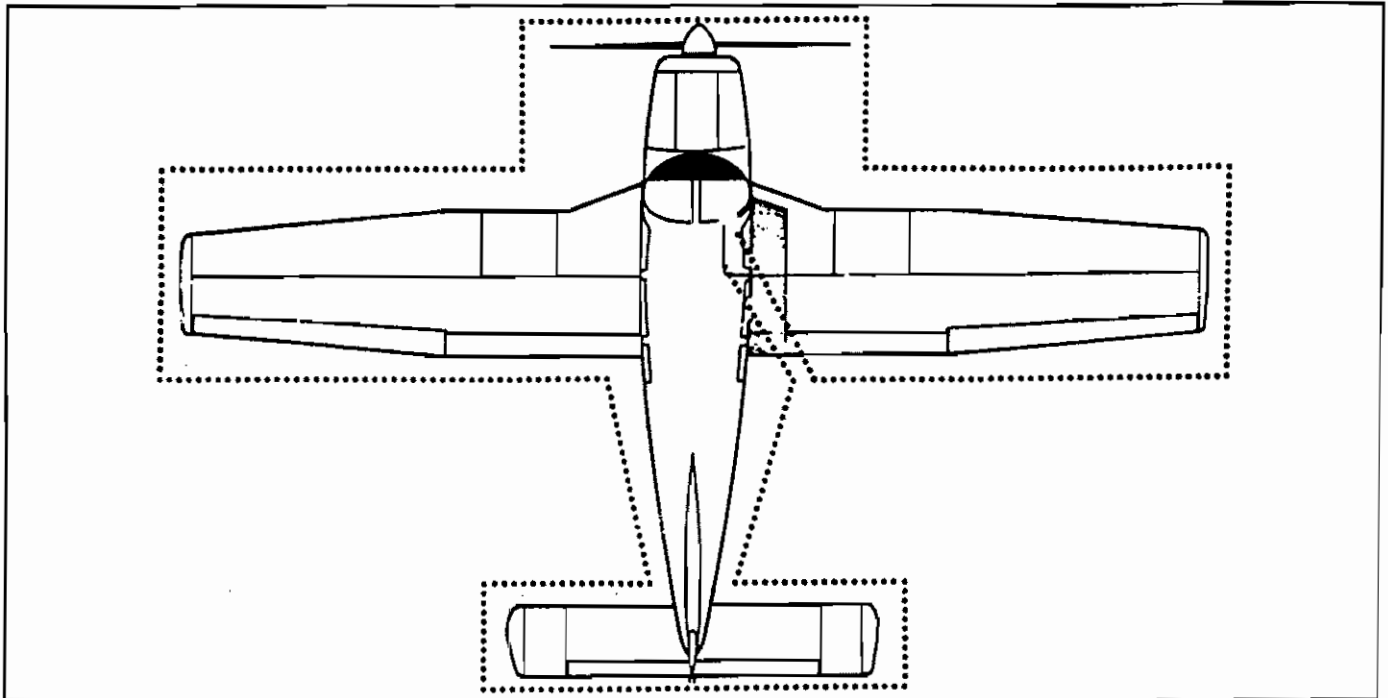

WALK-AROUND

Figure 4-1

4.5 NORMAL PROCEDURES CHECK LIST

PREFLIGHT CHECK

Control wheelrelease belts
 AvionicsOFF
 Master switchON
 Fuel quantity gaugescheck
 Master switchOFF
 IgnitionOFF
 Exteriorcheck for damage
 Control surfacescheck for interference - free of ice, snow, frost
 Hingescheck for interference
 Wingsfree of ice, snow, frost
 Stall warningcheck
 Tie down and chocksremove
 Navigation lightscheck
 Fuel tankscheck supply visually - secure caps
 Fuel tank sumpsdrain
 Fuel ventsopen
 Main gear strutsproper inflation (4.50 in.)
 Tirescheck
 Brake blockscheck

Pitot headremove cover - holes clear
 Windshieldclean
 Propeller and spinnercheck
 Fuel and oilcheck for leaks
 Oilcheck level
 Dipstickproperly seated
 Cowlingsecure
 Inspection coverssecure
 Nose wheel tirecheck
 Nose gear strutproper inflation (3.25 in.)
 Air inletsclear
 Alternator beltcheck tension
 Tow bar and control locksstow
 Baggagestowed properly - secure
 Baggage doorclose and secure
 Fuel strainerdrain
 Primary flight controlsproper operation
 Cabin doorclose and secure
 Required paperson board
 Seat belts and harnessfasten/adjust - check inertia reel

**SECTION 4
NORMAL PROCEDURES**

**PIPER AIRCRAFT CORPORATION
PA-28-161, CHEROKEE WARRIOR II**

BEFORE STARTING ENGINE

Brakesset
Carburetor heat.....full OFF
Fuel selector.....desired tank
RadiosOFF

STARTING ENGINE WHEN COLD

Throttle1/4" open
Master switchON
Electric fuel pumpON
Mixture.....full RICH
Starter.....engage
Throttleadjust
Oil pressure.....check

If engine does not start within 10 sec. prime and repeat starting procedure.

STARTING ENGINE WHEN HOT

Throttle1/2" open
Master switchON
Electric fuel pumpON
Mixture.....full RICH
Starter.....engage
Throttleadjust
Oil pressure.....check

STARTING ENGINE WHEN FLOODED

Throttleopen full
Master switchON
Electric fuel pump.....OFF
Mixture.....idle cut-off
Starter.....engage
Mixture.....advance
Throttleretard
Oil pressure.....check

STARTING WITH EXTERNAL POWER SOURCE

Master switch.....OFF
All electrical equipment.....OFF
Terminalsconnect
External power pluginsert in fuselage

Proceed with normal start

Throttlelowest possible RPM

External power plugdisconnect from fuselage

Master switch.....ON - check ammeter
Oil pressurecheck

WARM-UP

Throttle800 to 1200 RPM

TAXIING

Chocks.....removed
Taxi areaclear
Throttleapply slowly
Brakescheck
Steering.....check

GROUND CHECK

Throttle2000 RPM
Magnetosmax. drop 175 RPM
 -max. diff. 50 RPM
Vacuum.....5.0" Hg. \pm .1
Oil tempcheck
Oil pressure.....check
Air conditioner.....check
Annunciator panelpress-to-test
Carburetor heatcheck
Engine is warm for takeoff when throttle can be opened without engine faltering.
Electric fuel pump.....OFF
Fuel pressure.....check
Throttleretard

DESCENT

POWER OFF

Carburetor heatON if required
Throttle.....closed
Airspeed.....as required
Mixtureas required
Power.....verify with throttle every 30 seconds

APPROACH AND LANDING

Fuel selector.....proper tank
Seat backs.....erect
Belts/harnessfasten/adjust
Electric fuel pumpON
Mixtureset
Flapsset - 103 KIAS max
Air conditioner.....OFF
Trim to 70 KIAS
Final approach speed (flaps 40°)63 KIAS

STOPPING ENGINE

Flapsretract
Electric fuel pump.....OFF
Air conditioner.....OFF
RadiosOFF
Throttlefull aft
Mixtureidle cut-off
Magnetos.....OFF
Master switch.....OFF

PARKING

Parking brakeset
Control wheelsecured with belts
Flapsfull up
Wheel chocks.....in place
Tie downs.....secure

4.7 AMPLIFIED NORMAL PROCEDURES (GENERAL)

The following paragraphs are provided to supply detailed information and explanations of the normal procedures necessary for the safe operation of the airplane.

4.9 PREFLIGHT CHECK

The airplane should be given a thorough preflight and walk-around check. The preflight should include a check of the airplane's operational status, computation of weight and C.G. limits, takeoff distance and in-flight performance. A weather briefing should be obtained for the intended flight path, and any other factors relating to a safe flight should be checked before takeoff.

CAUTION

The flap position should be noted before boarding the aircraft. The flaps must be placed in the "UP" position before they will lock and support weight on the step.

Upon entering the cockpit, release the seat belts securing the control wheel. Turn off all avionics equipment. Turn the master switch "ON" and check the fuel quantity gauges for sufficient fuel. After the fuel quantity check is made turn the master switch "OFF" and check that the ignition switch is "OFF."

To begin the exterior walk-around, check for external damage and operational interference of the control surfaces or hinges. Insure that the wings and control surfaces are free of snow, ice, frost or any other foreign materials.

An operational check of the stall warning system and navigation lights should now be made. Turn the master switch "ON." Lift the detector while checking to determine if the horn is actuated and check that the navigation lights are illuminated. The master switch should be returned to the "OFF" position after the checks are complete.

A visual check of the fuel tank quantity should be performed. Remove the filler cap from each tank and visually check the supply and color. Be sure to secure the caps properly after the check is complete.

The fuel system sumps and strainer should be drained daily prior to the first flight and after refueling to avoid the accumulation of contaminants such as water or sediment. Each fuel tank is equipped with an individual quick drain located at the lower inboard rear corner of the tank. The fuel strainer is equipped with a quick drain located on the front lower corner of the firewall. Each of the fuel tank sumps should be drained first. Then the fuel strainer should be drained twice, once with the fuel selector valve on each tank. Each time fuel is drained, sufficient fuel should be allowed to flow to ensure removal of contaminants. This fuel should be collected in a suitable container, examined for contaminants, and then discarded.

CAUTION

When draining any amount of fuel, care should be taken to ensure that no fire hazard exists before starting the engine.

After draining, each quick drain should be checked to make sure it has closed completely and is not leaking.

Check all of the fuel tank vents to make sure they are open.

Next, a complete check of the landing gear. Check the main gear shock struts for proper inflation. There should be 4.50 inches of strut exposure under a normal static load. The nose gear should be checked for 3.25 inches of strut exposure. Check all tires for cuts and wear and insure proper inflation. Make a visual check of the brake blocks for wear or damage.

Remove the cover from the pitot head on the underside of the left wing. Check the pitot head to make sure the holes are open and clear of obstructions.

Don't forget to clean and check the windshield.

The propeller and spinner should be checked for defects or nicks.

Lift the cowling and check for any obvious fuel or oil leaks. Check the oil level. Make sure that the dipstick has properly seated after checking. Secure the cowling and check the inspection covers.

Check the air inlets for foreign matter and the alternator belt for proper tension.

Stow the tow bar and check the baggage for proper storage and security. The baggage compartment doors should be closed and secure.

Upon entering the aircraft, ascertain that all primary flight controls operate properly. Close and secure the cabin door and check that all the required papers are in order and in the airplane.

Fasten the seat belts and shoulder harness and check the function of the inertia reel by pulling sharply on the strap. Fasten seat belts on empty seats.

NOTE

If the fixed shoulder harness (non-inertia reel type) is installed, it must be connected to the seat belt and adjusted to allow proper accessibility to all controls including fuel selector, flaps, trim, etc., while maintaining adequate restraint for the occupant.

If the inertia reel type shoulder harness is installed, a pull test of its locking restraint feature should be performed.

4.11 BEFORE STARTING ENGINE

Before starting the engine the brakes should be set "ON" and the carburetor heat lever moved to the full OFF position. The fuel selector should then be moved to the desired tank. Check to make sure that all the radios are OFF.

4.13 STARTING ENGINE

(a) Starting Engine When Cold

Open the throttle lever approximately 1/4 inch. Turn "ON" the master switch and the electric fuel pump.

Move the mixture control to full "RICH" and engage the starter by rotating the magneto switch clockwise. When the engine fires, release the magneto switch, and move the throttle to the desired setting.

If the engine does not fire within five to ten seconds, disengage the starter, prime the engine and repeat the starting procedure.

(b) Starting Engine When Hot

Open the throttle approximately 1/2 inch. Turn "ON" the master switch and the electric fuel pump. Move the mixture control lever to full RICH and engage the starter by rotating the magneto switch clockwise. When the engine fires, release the magneto switch and move the throttle to the desired setting.

(c) Starting Engine When Flooded

The throttle lever should be full "OPEN." Turn "ON" the master switch and turn "OFF" the electric fuel pump. Move the mixture control lever to idle cut-off and engage the starter by rotating the magneto switch clockwise. When the engine fires, release the magneto switch, advance the mixture and retard the throttle.

(d) Starting Engine With External Power Source

An optional feature called the Piper External Power (PEP) allows the operator to use an external battery to crank the engine without having to gain access to the airplane's battery.

Turn the master switch OFF and turn all electrical equipment OFF. Connect the RED lead of the PEP kit jumper cable to the POSITIVE (+) terminal of an external 12-volt battery and the BLACK lead to the NEGATIVE (-) terminal. Insert the plug of the jumper cable into the socket located on the fuselage. Note that when the plug is inserted, the electrical system is ON. Proceed with the normal starting technique.

After the engine has started, reduce power to the lowest possible RPM, to reduce sparking, and disconnect the jumper cable from the aircraft. Turn the master switch ON and check the alternator ammeter for an indication of output. DO NOT ATTEMPT FLIGHT IF THERE IS NO INDICATION OF ALTERNATOR OUTPUT.

NOTE

For all normal operations using the PEP jumper cables, the master switch should be OFF, but it is possible to use the ship's battery in parallel by turning the master switch ON. This will give longer cranking capabilities, but will not increase the amperage.

CAUTION

Care should be exercised because if the ship's battery has been depleted, the external power supply can be reduced to the level of the ship's battery. This can be tested by turning the master switch ON momentarily while the starter is engaged. If cranking speed increases, the ship's battery is at a higher level than the external power supply.

When the engine is firing evenly, advance the throttle to 800 RPM. If oil pressure is not indicated within thirty seconds, stop the engine and determine the trouble. In cold weather it will take a few seconds longer to get an oil pressure indication. If the engine has failed to start, refer to the Lycoming Operating Handbook, Engine Troubles and Their Remedies.

Starter manufacturers recommend that cranking periods be limited to thirty seconds with a two minute rest between cranking periods. Longer cranking periods will shorten the life of the starter.

4.15 WARM-UP

Warm-up the engine at 800 to 1200 RPM for not more than two minutes in warm weather and four minutes in cold. Avoid prolonged idling at low RPM, as this practice may result in fouled spark plugs.

Takeoff may be made as soon as the ground check is completed, provided that the throttle may be opened fully without backfiring or skipping, and without a reduction in engine oil pressure.

Do not operate the engine at high RPM when running up or taxiing over ground containing loose stones, gravel or any loose material that may cause damage to the propeller blades.

4.17 TAXIING

Before attempting to taxi the airplane, ground personnel should be instructed and approved by a qualified person authorized by the owner. Ascertain that the propeller back blast and taxi areas are clear.

Power should be applied slowly to start the taxi roll. Taxi a few feet forward and apply the brakes to determine their effectiveness. While taxiing, make slight turns to ascertain the effectiveness of the steering.

Observe wing clearances when taxiing near buildings or other stationary objects. If possible, station an observer outside the airplane.

Avoid holes and ruts when taxiing over uneven ground.

Do not operate the engine at high RPM when running up or taxiing over ground containing loose stones, gravel or any loose material that may cause damage to the propeller blades.

4.19 GROUND CHECK

The magnetos should be checked at 2000 RPM. Drop off on either magneto should not exceed 175 RPM and the difference between the magnetos should not exceed 50 RPM. Operation on one magneto should not exceed 10 seconds.

Check the vacuum gauge; the indicator should read 5.0" \pm .1" Hg at 2000 RPM.

Check the annunciator panel lights with the press-to-test button. Also check the air conditioner.

Carburetor heat should also be checked prior to takeoff to be sure the control is operating properly and to clear any ice which may have formed during taxiing. Avoid prolonged ground operation with carburetor heat "ON" as the air is unfiltered.

The electric fuel pump should be turned "OFF" after starting or during warm-up to make sure that the engine driven pump is operating. Prior to takeoff the electric pump should be turned ON again to prevent loss of power during takeoff should the engine driven pump fail. Check both oil temperature and oil pressure. The temperature may be low for some time if the engine is being run for the first time of the day. The engine is warm enough for takeoff when the throttle can be opened without the engine faltering.

4.21 BEFORE TAKEOFF

All aspects of each particular takeoff should be considered prior to executing the takeoff procedure.

Turn "ON" the master switch and check and set all of the flight instruments as required. Check the fuel selector to make sure it is on the proper tank (fullest). Turn "ON" the electric fuel pump and check the engine gauges. The carburetor heat should be in the "OFF" position.

All seat backs should be erect and the seat belts and shoulder harness fastened. Fasten the seat belts snugly around the empty seats.

NOTE

If the fixed shoulder harness (non-inertia reel type) is installed, it must be connected to the seat belt and adjusted to allow proper accessibility to all controls including fuel selector, flaps, trim, etc., while maintaining adequate restraint for the occupant.

If the inertia reel type shoulder harness is installed, a pull test of its locking restraint feature should be performed.

The mixture should be set and the primer checked to insure that it is locked.

NOTE

The mixture should be set FULL RICH except a minimum amount of leaning is permitted for smooth engine operation when taking off at high elevation.

Exercise and set the flaps and trim tab. Insure proper flight control movement and response. All doors should be properly secured and latched. On air conditioned models, the air conditioner must be "OFF" to insure normal takeoff performance.

4.23 TAKEOFF

The normal takeoff technique is conventional. The tab should be set slightly aft of neutral, with the exact setting determined by the loading of the airplane. Allow the airplane to accelerate to 45 to 55 KIAS depending on the weight of the aircraft and ease back on the control wheel to rotate to climb attitude. Premature raising of the nose or raising it to an excessive angle will result in a delayed takeoff. After takeoff, let the airplane accelerate to the desired climb speed by lowering the nose slightly.

Takeoffs are normally made with flaps up; however, for short field takeoffs and for takeoffs under difficult conditions such as deep grass or a soft surface, total distances can be reduced appreciably by lowering the flaps to 25° and rotating at lower airspeed.

A short field takeoff with an obstacle clearance is accomplished by first lowering the flaps to 25°. Apply full power before brake release and accelerate to 52 KIAS and rotate. Maintain 52 KIAS until

obstacle clearance is attained. After the obstacle has been cleared, accelerate to 79 KIAS and then slowly retract the flaps.

A short field takeoff with no obstacle is accomplished with no flaps and applying full power before brake release, lift off at 50 KIAS and accelerate to best rate of climb speed, 79 KIAS.

Takeoff from a soft field with an obstacle clearance requires the use of 25° flaps. Accelerate the airplane and lift the nose gear off as soon as possible and lift off at the lowest possible airspeed. Accelerate just above the ground to 52 KIAS to climb past obstacle clearance height. Continue climbing while accelerating to the best rate of climb speed, 79 KIAS and slowly retract the flaps.

For a soft field takeoff without an obstacle to clear, extend the flaps 25°, accelerate the airplane and lift the nose gear off as soon as possible. Lift off at the lowest possible airspeed. Accelerate just above the ground to the best rate of climb speed, 79 KIAS and retract the flaps while climbing out.

4.25 CLIMB

The best rate of climb at gross weight will be obtained at 79 KIAS. The best angle of climb may be obtained at 63 KIAS. At lighter than gross weight these speeds are reduced somewhat. For climbing en route, a speed of 87 KIAS is recommended. This will produce better forward speed and increased visibility over the nose during the climb.

When reaching the desired altitude, the electric fuel pump may be turned off.

4.27 CRUISING

The cruising speed is determined by many factors, including power setting, altitude, temperature, loading and equipment installed in the airplane.

The normal maximum cruising power is 75% of the rated horsepower of the engine. Airspeeds which may be obtained at various altitudes and power settings can be determined from the performance graphs provided by Section 5.

Use of the mixture control in cruising flight reduces fuel consumption significantly, especially at higher altitudes, and reduces lead deposits when the alternate fuels are used. During letdown and low power flight operations, it may be necessary to lean because of excessively rich mixture. The mixture should be leaned during cruising operation when 75% power or less is being used. If any doubt exists as to the amount of power being used, the mixture should be in the FULL RICH position for all operations. Always enrich the mixture before increasing power settings.

To lean the mixture, disengage the lock and pull the mixture control until the engine becomes rough, indicating that the lean mixture limit has been reached in the leaner cylinders. Then enrich the mixture by pushing the control towards the instrument panel until engine operation becomes smooth. When leaning, carefully observe the temperature instruments.

Always remember that the electric fuel pump should be turned "ON" before switching tanks, and should be left on for a short period thereafter. In order to keep the airplane in best lateral trim during cruising flight, the fuel should be used alternately from each tank. It is recommended that one tank be used for one hour after takeoff, then the other tank be used for two hours; then return to the first tank, which

**SECTION 4
NORMAL PROCEDURES**

**PIPER AIRCRAFT CORPORATION
PA-28-161, CHEROKEE WARRIOR II**

will have approximately one and one half hours of fuel remaining if the tanks were full at takeoff. The second tank will contain approximately one half hour of fuel. Do not run tanks completely dry in flight. The electric fuel pump should be normally "OFF" so that any malfunction of the engine driven fuel pump is immediately apparent. If signs of fuel starvation should occur at any time during flight, fuel exhaustion should be suspected, at which time the fuel selector should be immediately positioned to the other tank and the electric fuel pump switched to the "ON" position.

4.28 DESCENT

NORMAL

To achieve the performance on Figure 5-25 the power on descent must be used. The throttle should be set for 2500 RPM, mixture full rich and maintain an airspeed of 126 KIAS. In case carburetor ice is encountered apply full carburetor heat.

POWER OFF

If a prolonged power off descent is to be made, apply full carburetor heat prior to power reduction if icing conditions are suspected. Throttle should be retarded and mixture control leaned as required. Power response should be verified approximately every 30 seconds by partially opening and then closing the throttle (clearing the engine). When leveling off enrichen mixture, set power as required and select carburetor heat off unless carburetor icing conditions are suspected.

4.29 APPROACH AND LANDING

Check to insure the fuel selector is on the proper (fullest) tank and that the seat backs are erect. The seat belts and shoulder harness should be fastened and the inertia reel checked.

NOTE

If the fixed shoulder harness (non-inertia reel type) is installed, it must be connected to the seat belt and adjusted to allow proper accessibility to all controls including fuel selector, flaps, trim, etc., while maintaining adequate restraint for the occupant.

If the inertia reel type shoulder harness is installed, a pull test of its locking restraint feature should be performed.

Turn the electric fuel pump "ON" and turn the air conditioner "OFF." The mixture should be set in the full "RICH" position.

The airplane should be trimmed to an initial-approach speed of about 70 KIAS with a final-approach speed of 63 KIAS with flaps extended to 40°. The flaps can be lowered at speeds up to 103 KIAS, if desired.

The mixture control should be kept in full "RICH" position to insure maximum acceleration if it should be necessary to open the throttle again. Carburetor heat should not be applied unless there is an indication of carburetor icing, since the use of carburetor heat causes a reduction in power which may be critical in case of a go-around. Full throttle operation with carburetor heat on can cause detonation.

The amount of flap used during landings and the speed of the aircraft at contact with the runway should be varied according to the landing surface and conditions of wind and airplane loading. It is generally good practice to contact the ground at the minimum possible safe speed consistent with existing conditions.

Normally, the best technique for short and slow landings is to use full flap and enough power to maintain the desired airspeed and approach flight path. Mixture should be full "RICH," fuel on the fullest tank, and electric fuel pump "ON." Reduce the speed during the flareout and contact the ground close to the stalling speed. After ground contact hold the nose wheel off as long as possible. As the airplane slows down, gently lower the nose and apply the brakes. Braking is most effective when flaps are raised and back pressure is applied to the control wheel, putting most of the aircraft weight on the main wheels. In high wind conditions, particularly in strong crosswinds, it may be desirable to approach the ground at higher than normal speeds with partial or no flaps.

4.31 STOPPING ENGINE

At the pilot's discretion, the flaps should be raised and the electric fuel pump turned "OFF." The air conditioner and radios should be turned "OFF," and the engine stopped by disengaging the mixture control lock and pulling the mixture control back to idle cut-off. The throttle should be left full aft to avoid engine vibration while stopping. Then the magneto and master switches must be turned "OFF."

NOTE

When alternate fuels are used, the engine should be run up to 1200 RPM for one minute prior to shutdown to clean out any unburned fuel.

NOTE

The flaps must be placed in the "UP" position for the flap step to support weight. Passengers should be cautioned accordingly.

4.33 PARKING

If necessary, the airplane should be moved on the ground with the aid of the nose wheel tow bar provided with each airplane and secured behind the rear seats. The aileron and stabilator controls should be secured by looping the safety belt through the control wheel and pulling it snug. The flaps are locked when in the "UP" position and should be left retracted.

Tie downs can be secured to rings provided under each wing and to the tail skid. The rudder is held in position by its connections to the nose wheel steering and normally does not have to be secured.

4.35 STALLS

The stall characteristics are conventional. An approaching stall is indicated by a stall warning horn which is activated between five and ten KTS above stall speed. Mild airframe buffeting and gentle pitching may also precede the stall.

The gross weight stalling speed with power off and full flaps is 44 KIAS. With the flaps up this speed is increased. Loss of altitude during stalls varies from 100 to 275 feet, depending on configuration and power.

NOTE

The stall warning system is inoperative with the master switch "OFF."

During preflight, the stall warning system should be checked by turning the master switch "ON," lifting the detector and checking to determine if the horn is actuated. The master switch should be returned to the "OFF" position after the check is complete.

4.37 TURBULENT AIR OPERATION

In keeping with good operating practice used in all aircraft, it is recommended that when turbulent air is encountered or expected, the airspeed be reduced to maneuvering speed to reduce the structural loads caused by gusts and to allow for inadvertent speed build-ups which may occur as a result of the turbulence or of distractions caused by the conditions. (See Subsection 2.3)

4.39 WEIGHT AND BALANCE

It is the responsibility of the owner and pilot to determine that the airplane remains within the allowable weight vs. center of gravity envelope while in flight.

For weight and balance data, refer to Section 6 (Weight and Balance).

TABLE OF CONTENTS

SECTION 5

PERFORMANCE

Paragraph No.		Page No.
5.1	General	5-1
5.3	Introduction to Performance and Flight Planning	5-1
5.5	Flight Planning Example.....	5-3
5.7	Performance Graphs.....	5-9
	List of Figures	5-9



SECTION 5
PERFORMANCE

5.1 GENERAL

All of the required (FAA regulations) and complementary performance information applicable to this aircraft is provided by this section.

Performance information associated with those optional systems and equipment which require handbook supplements is provided by Section 9 (Supplements).

5.3 INTRODUCTION TO PERFORMANCE AND FLIGHT PLANNING

The performance information presented in this section is based on measured Flight Test Data corrected to I.C.A.O. standard day conditions and analytically expanded for the various parameters of weight, altitude, temperature, etc.

The performance charts are unfactored and do not make any allowance for varying degrees of pilot proficiency or mechanical deterioration of the aircraft. This performance, however, can be duplicated by following the stated procedures in a properly maintained airplane.

Effects of conditions not considered on the charts must be evaluated by the pilot, such as the effect of soft or grass runway surface on takeoff and landing performance, or the effect of winds aloft on cruise and range performance. Endurance can be grossly affected by improper leaning procedures, and inflight fuel flow and quantity checks are recommended.

REMEMBER! To get chart performance, follow the chart procedures.

The information provided by paragraph 5.5 (Flight Planning Example) outlines a detailed flight plan using the performance charts in this section. Each chart includes its own example to show how it is used.

WARNING

Performance information derived by extrapolation beyond the limits shown on the charts should not be used for flight planning purposes.

THIS PAGE INTENTIONALLY LEFT BLANK

5.5 FLIGHT PLANNING EXAMPLE

(a) Aircraft Loading

The first step in planning our flight is to calculate the airplane weight and center of gravity by utilizing the information provided by Section 6 (Weight and Balance) of this handbook.

The basic empty weight for the airplane as delivered from the factory has been entered in Figure 6-5. If any alterations to the airplane have been made effecting weight and balance, reference to the aircraft logbook and Weight and Balance Record (Figure 6-7) should be made to determine the current basic empty weight of the airplane.

Make use of the Weight and Balance Loading Form (Figure 6-11) and the C.G. Range and Weight graph (Figure 6-15) to determine the total weight of the airplane and the center of gravity position.

After proper utilization of the information provided we have found the following weights for consideration in our flight planning example.

The landing weight cannot be determined until the weight of the fuel to be used has been established [refer to item (g)(1)].

(1) Basic Empty Weight	1391 lbs.
(2) Occupants (4 x 170 lbs.)	680 lbs.
(3) Baggage and Cargo	50 lbs.
(4) Fuel (6 lb/gal x 30)	180 lbs.
(5) Takeoff Weight	2316 lbs.
(6) Landing Weight	
(a)(5) minus (g)(1), (2316 lbs. minus 134.4 lbs.)	2181.6 lbs.

Our takeoff weight is below the maximum of 2325 lbs. and our weight and balance calculations have determined our C.G. position within the approved limits.

(b) Takeoff and Landing

Now that we have determined our aircraft loading, we must consider all aspects of our takeoff and landing.

All of the existing conditions at the departure and destination airport must be acquired, evaluated and maintained throughout the flight.

Apply the departure airport conditions and takeoff weight to the appropriate Takeoff Performance graph (Figures 5-5 and 5-6 or 5-7 and 5-8) to determine the length of runway necessary for the takeoff and/or the barrier distance.

The landing distance calculations are performed in the same manner using the existing conditions at the destination airport and, when established, the landing weight.

**SECTION 5
PERFORMANCE**

**PIPER AIRCRAFT CORPORATION
PA-28-161, CHEROKEE WARRIOR II**

The conditions and calculations for our example flight are listed below. The takeoff and landing distances required for our example flight have fallen well below the available runway lengths.

	Departure Airport	Destination Airport
(1) Pressure Altitude	1500 ft.	2500 ft.
(2) Temperature	80°F (27°C)	75°F (24°C)
(3) Wind Component	15 KTS (Headwind)	0 KTS
(4) Runway Length Available	4800 ft.	7600 ft.
(5) Runway Required	2100 ft.*	1190**

NOTE

The remainder of the performance charts used in this flight plan example assume a no wind condition. The effect of winds aloft must be considered by the pilot when computing climb, cruise and descent performance.

(c) Climb

The next step in our flight plan is to determine the necessary climb segment components.

The desired cruise pressure altitude and corresponding cruise outside air temperature values are the first variables to be considered in determining the climb components from the Time, Distance, and Fuel to Climb graph (Figure 5-13). After the time, distance and fuel for the cruise pressure altitude and outside air temperature values have been established, apply the existing conditions at the departure field to graph (Figure 5-13). Now, subtract the values obtained from the graph for the field of departure conditions from those for the cruise pressure altitude.

The remaining values are the true fuel, distance and time components for the climb segment of the flight plan corrected for field pressure altitude and temperature.

The following values were determined from the above instructions in our flight planning example.

(1) Cruise Pressure Altitude	5000 ft.
(2) Cruise OAT	60°F (16°C)
(3) Time to Climb (10.0 min. minus 2.5 min.)	7.5 min.***
(4) Distance to Climb (13.5 miles minus 3.5 miles)	10.0 miles***
(5) Fuel to Climb (2 gal. minus .5 gal.)	1.5 gal.***

* reference Figure 5-6

** reference Figure 5-29

*** reference Figure 5-13

(d) Descent

The descent data will be determined prior to the cruise data to provide the descent distance for establishing the total cruise distance.

Utilizing the cruise pressure altitude and OAT we determine the basic time, distance and fuel for descent (Figure 5-25). These figures must be adjusted for the field pressure altitude and temperature at the destination airport. To find the necessary adjustment values, use the existing pressure altitude and temperature conditions at the destination airport as variables to find the time, distance and fuel values from the graph (Figure 5-25). Now, subtract the values obtained from the field conditions from the values obtained from the cruise conditions to find the true time, distance and fuel values needed for the flight plan.

The values obtained by proper utilization of the graphs for the descent segment of our example are shown below.

(1) Time to Descend (6.5 min. minus 3.5 min.)	3.0 min.*
(2) Distance to Descend (14 miles minus 7.5 miles)	6.5 miles*
(3) Fuel to Descend (1.0 gal. minus .5 gal.)	.5 gal.*

(e) Cruise

Using the total distance to be traveled during the flight, subtract the previously calculated distance to climb and distance to descend to establish the total cruise distance. Refer to the appropriate Avco Lycoming Operator's Manual when selecting the cruise power setting. The established pressure altitude and temperature values and the selected cruise power should now be utilized to determine the true airspeed from the Cruise Performance graph (Figures 5-15 through 5-18).

Calculate the cruise fuel consumption for the cruise power setting from the information provided by the Avco Lycoming Operator's Manual.

The cruise time is found by dividing the cruise distance by the cruise speed and the cruise fuel is found by multiplying the cruise fuel consumption by the cruise time.

The cruise calculations established for the cruise segment of our flight planning example are as follows:

(1) Total Distance	300 miles
(2) Cruise Distance	
(e)(1) minus (c)(4) minus (d)(2), (300 minus 10 miles minus 6.5 miles)	283.5 miles
(3) Cruise Power, Best Economy Mixture	75% rated power (2645 RPM)
(4) Cruise Speed	118 KTS TAS**
(5) Cruise Fuel Consumption	8.5 GPH
(6) Cruise Time	
(e)(2) divided by (c)(4), (283.5 miles divided by 118 KTS)	2.40 hrs.
(7) Cruise Fuel	
(e)(5) multiplied by (e)(6), (8.5 GPH multiplied by 2.40 hrs.)	20.4 gal.

* reference Figure 5-25

** reference Figure 5-17

**SECTION 5
PERFORMANCE**

**PIPER AIRCRAFT CORPORATION
PA-28-161, CHEROKEE WARRIOR II**

(f) Total Flight Time

The total flight time is determined by adding the time to climb, the time to descend and the cruise time. Remember! The time values taken from the climb and descent graphs are in minutes and must be converted to hours before adding them to the cruise time.

The following flight time is required for our flight planning example.

(1) Total Flight Time
(c)(3) plus (d)(1) plus (e)(6), (.13 hrs. plus .05 hrs. plus 2.40 hrs.) 2.58 hrs.

(g) Total Fuel Required

Determine the total fuel required by adding the fuel to climb, the fuel to descend and the cruise fuel. When the total fuel (in gallons) is determined, multiply this value by 6 lb/gal to determine the total fuel weight used for the flight.

The total fuel calculations for our example flight plan are shown below.

(1) Total Fuel Required
(c)(5) plus (d)(3) plus (e)(7), (1.5 gal. plus .5 gal. plus 20.4 gal.) 22.4 gal.
(22.4 gal. multiplied by 6 lb/gal.) 134.4 lbs.

THIS PAGE INTENTIONALLY LEFT BLANK

THIS PAGE INTENTIONALLY LEFT BLANK

PA-28-161

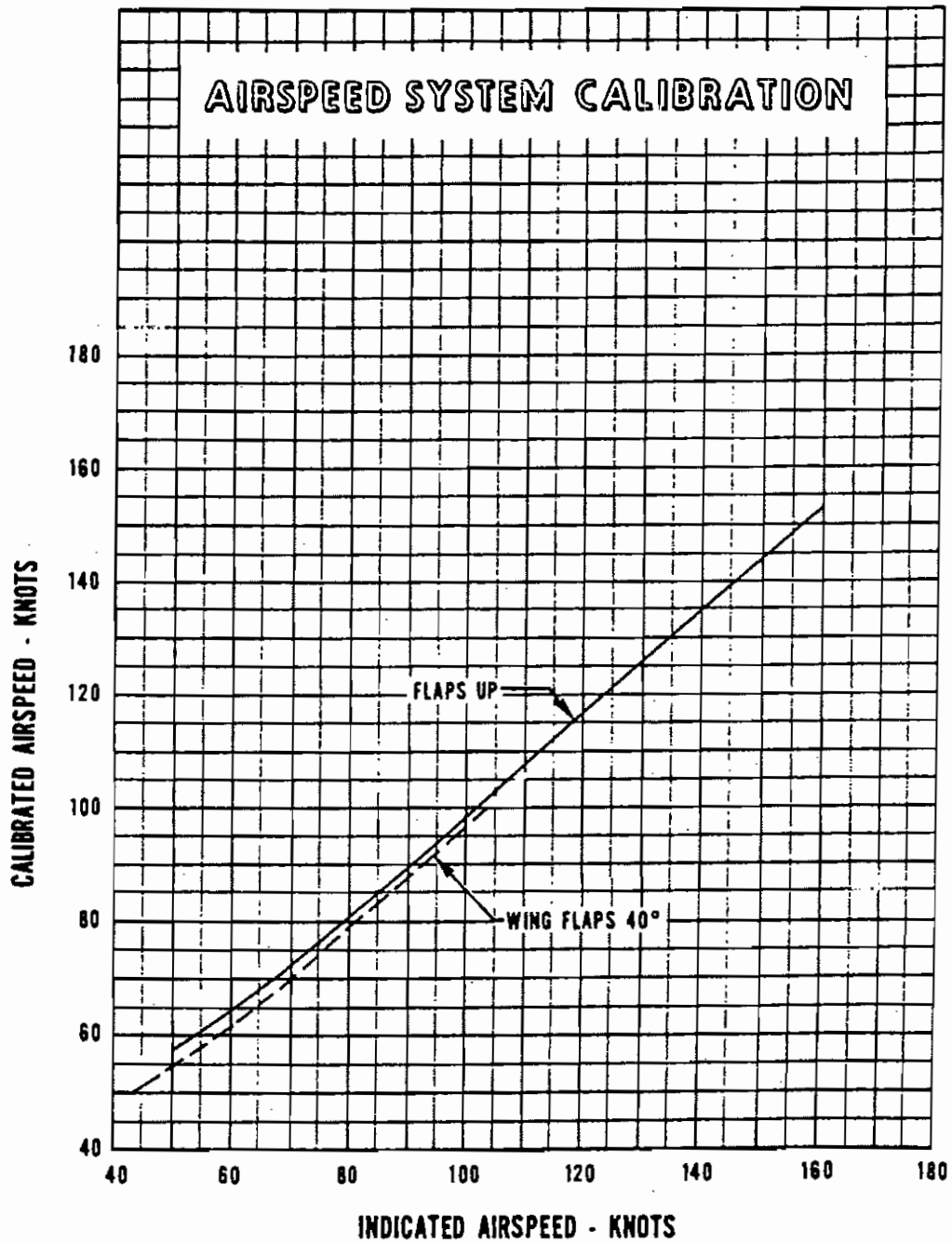

AIRSPEED SYSTEM CALIBRATION

Figure 5-1

PA-28-161

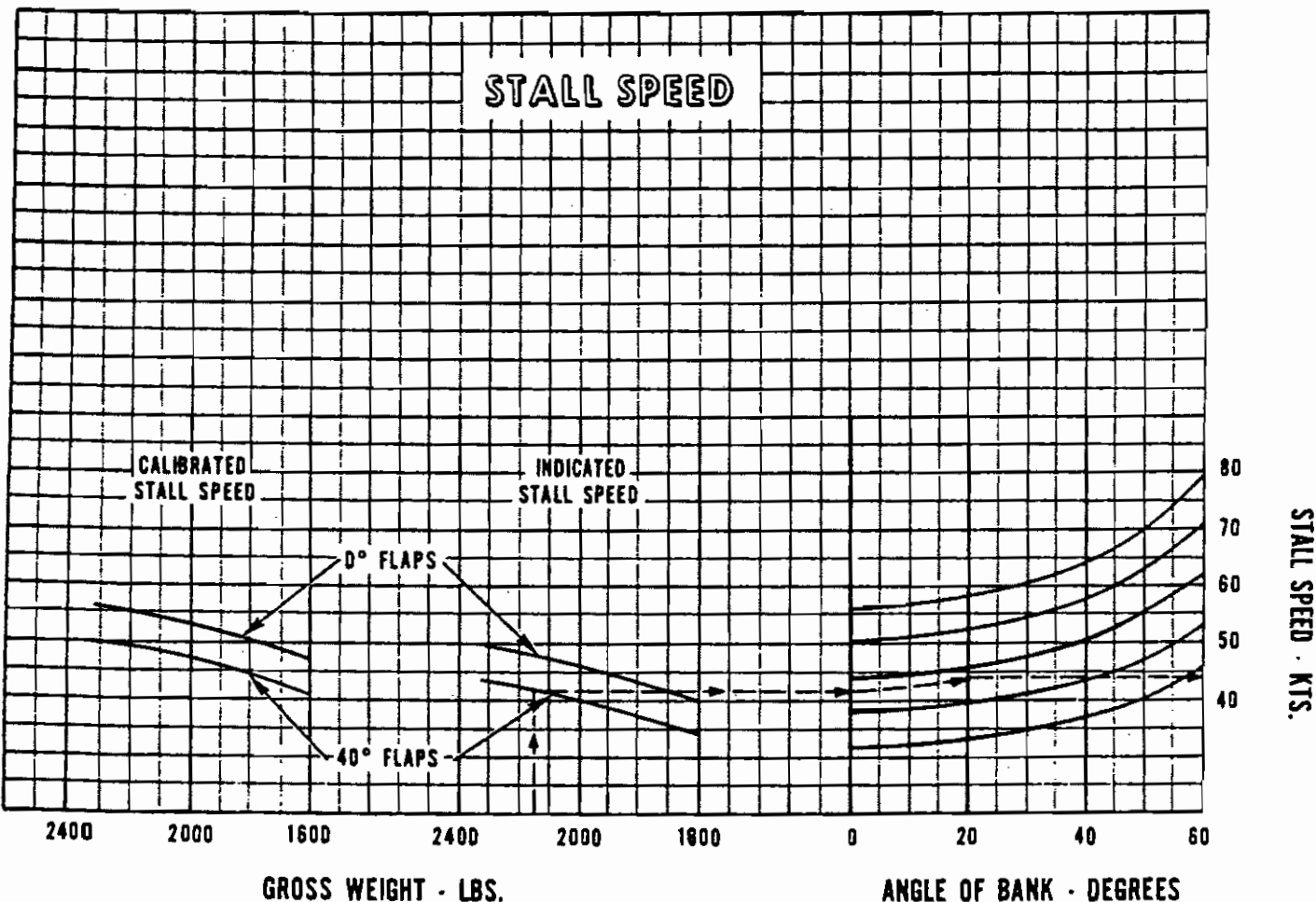

Example:
 Gross weight: 2170 lbs.
 Angle of bank: 20°
 Flap position: 40°
 Stall speed, indicated: 44 KTS

STALL SPEED
Figure 5-3

PA-28-161

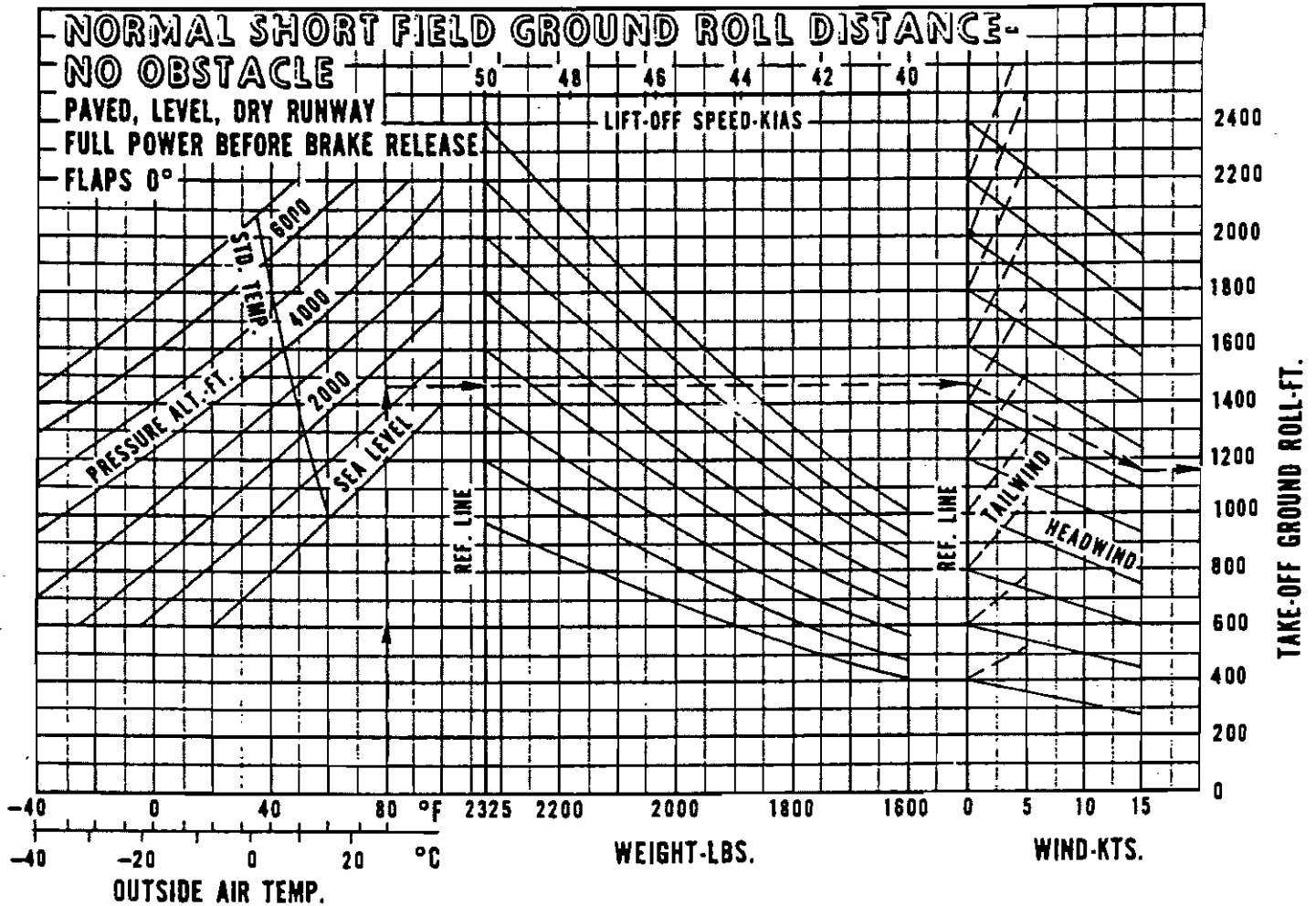

Example:

Departure airport pressure altitude: 1500 ft.
 Departure airport temperature: 80°F
 Weight: 2325 lbs.
 Wind: 15 KTS headwind
 Ground roll: 1150 ft.
 Lift-off speed: 50 KIAS

NORMAL SHORT FIELD GROUND ROLL DISTANCE - NO OBSTACLE

Figure 5-5

PA-28-161

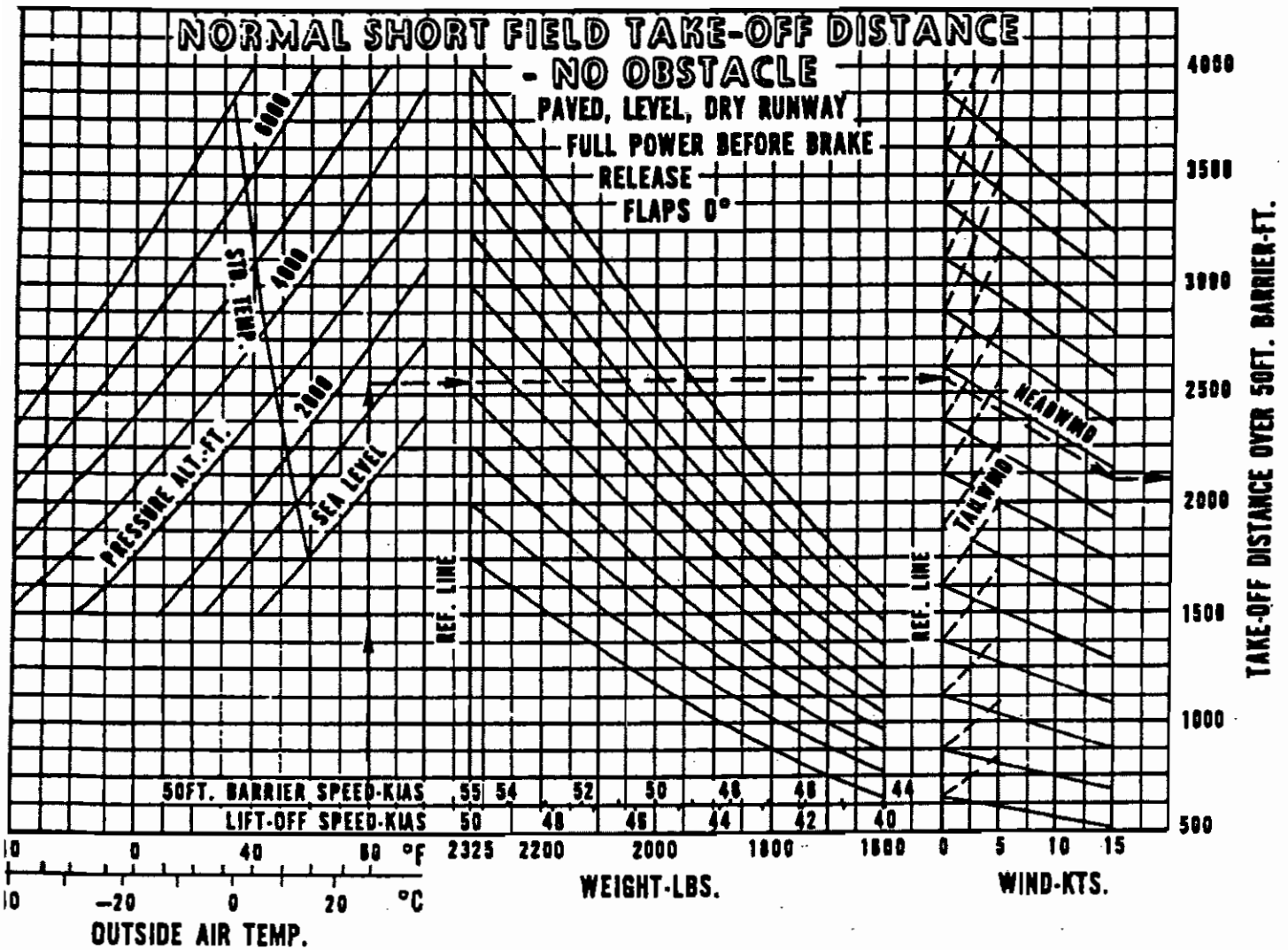

Example:
 Departure airport pressure altitude: 1500 ft.
 Departure airport temperature: 80°F
 Weight: 2325 lbs.
 Wind: 15 KTS headwind
 Distance over 50 ft. barrier: 2100 ft.
 Lift-off speed: 50 KIAS
 Barrier speed: 55 KIAS

NORMAL SHORT FIELD TAKEOFF DISTANCE - NO OBSTACLE

Figure 5-6

PA-28-161

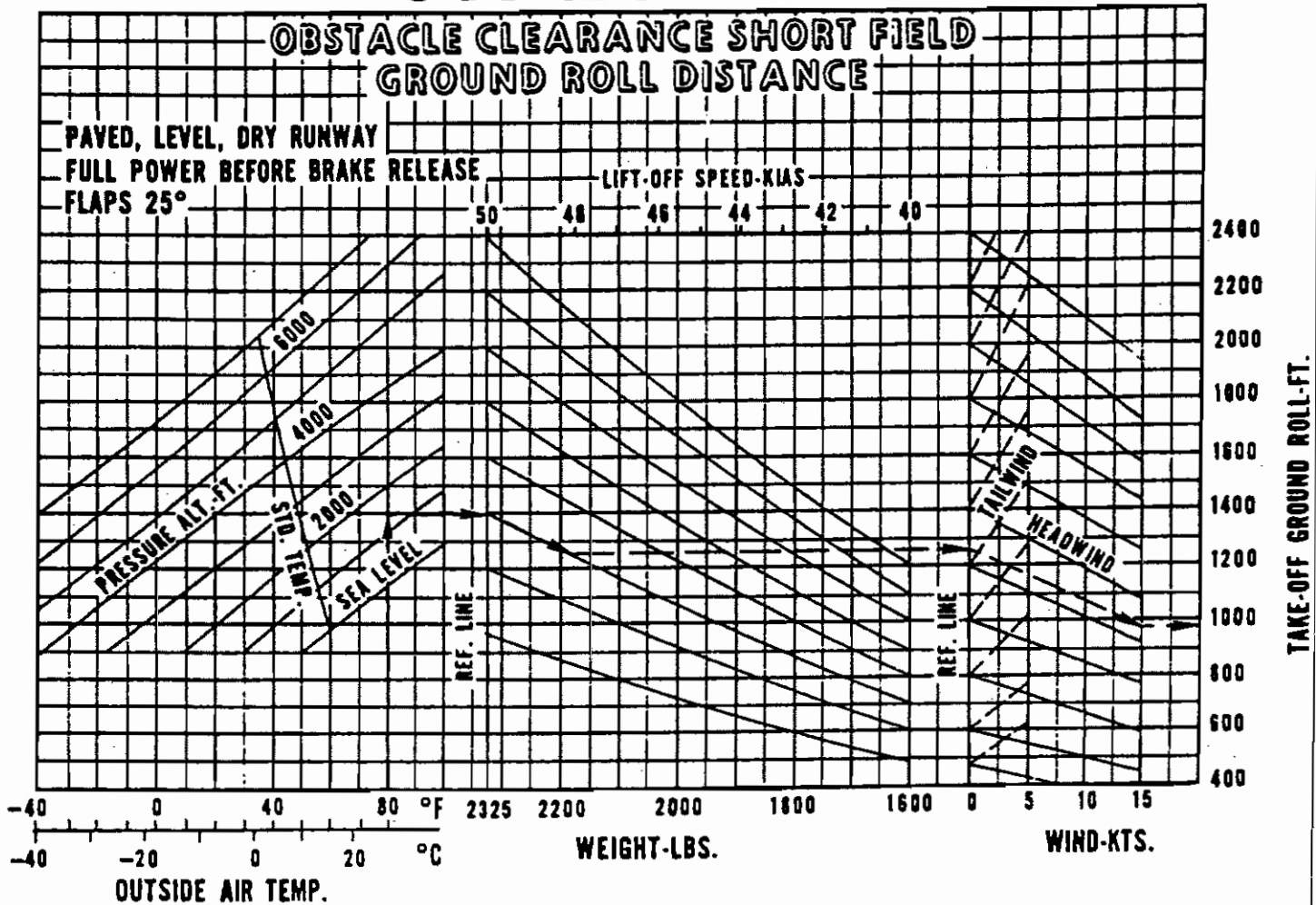

Example:

Departure airport pressure altitude: 1500 ft.
 Departure airport temperature: 80°F
 Weight: 2175 lbs.
 Wind: 15 KTS headwind
 Ground roll: 975 ft.
 Lift-off speed: 48 KIAS

OBSTACLE CLEARANCE SHORT FIELD GROUND ROLL DISTANCE

Figure 5-7

PA-28-161

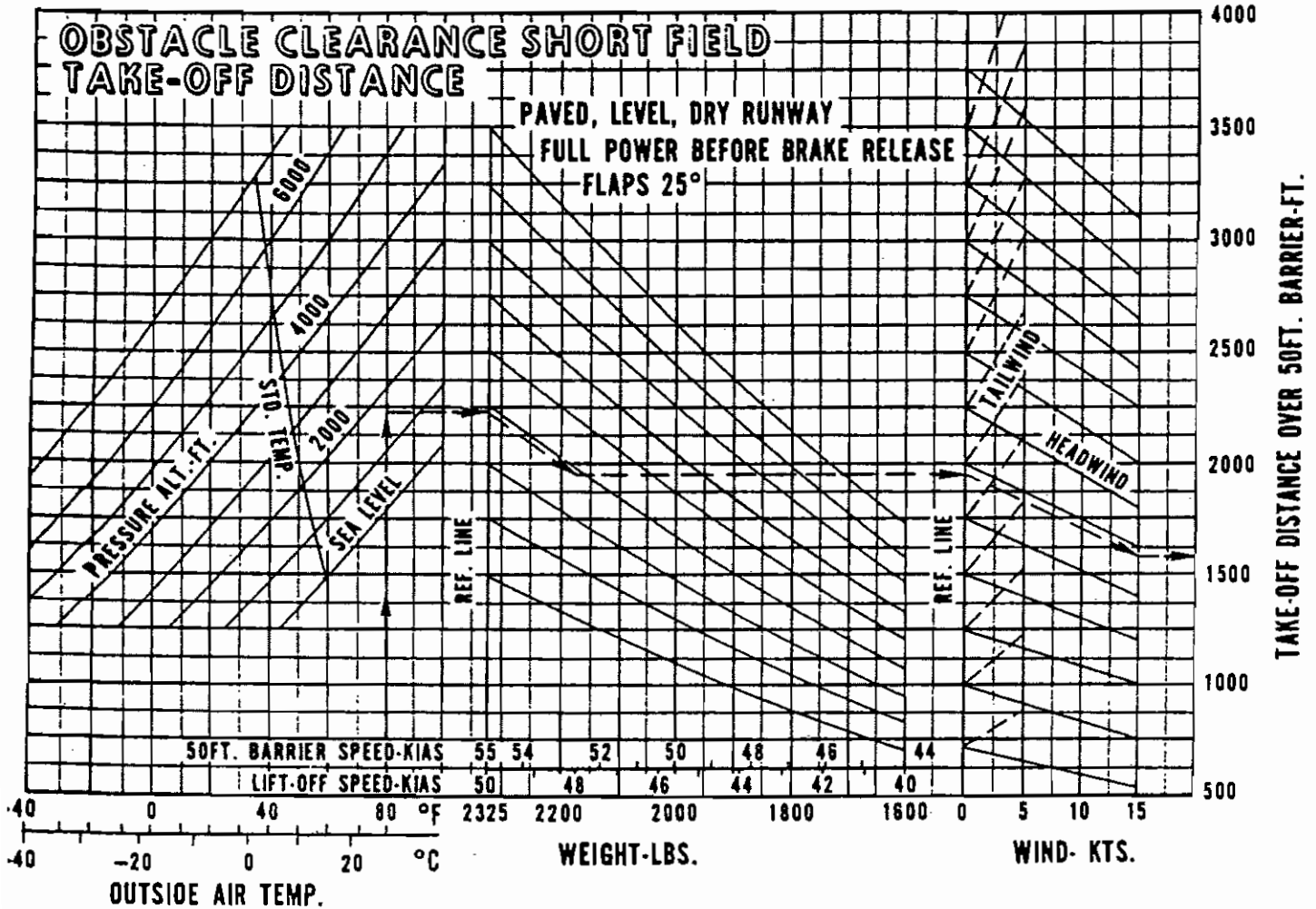

Example:
 Departure airport pressure altitude: 1500 ft.
 Departure airport temperature: 80°F
 Weight: 2175 lbs.
 Wind: 15 KTS headwind
 Distance over 50 ft. barrier: 1600 ft.
 Lift-off speed: 48 KIAS
 Barrier speed: 53 KIAS

OBSTACLE CLEARANCE SHORT FIELD TAKEOFF DISTANCE

Figure 5-8

PA-28-161

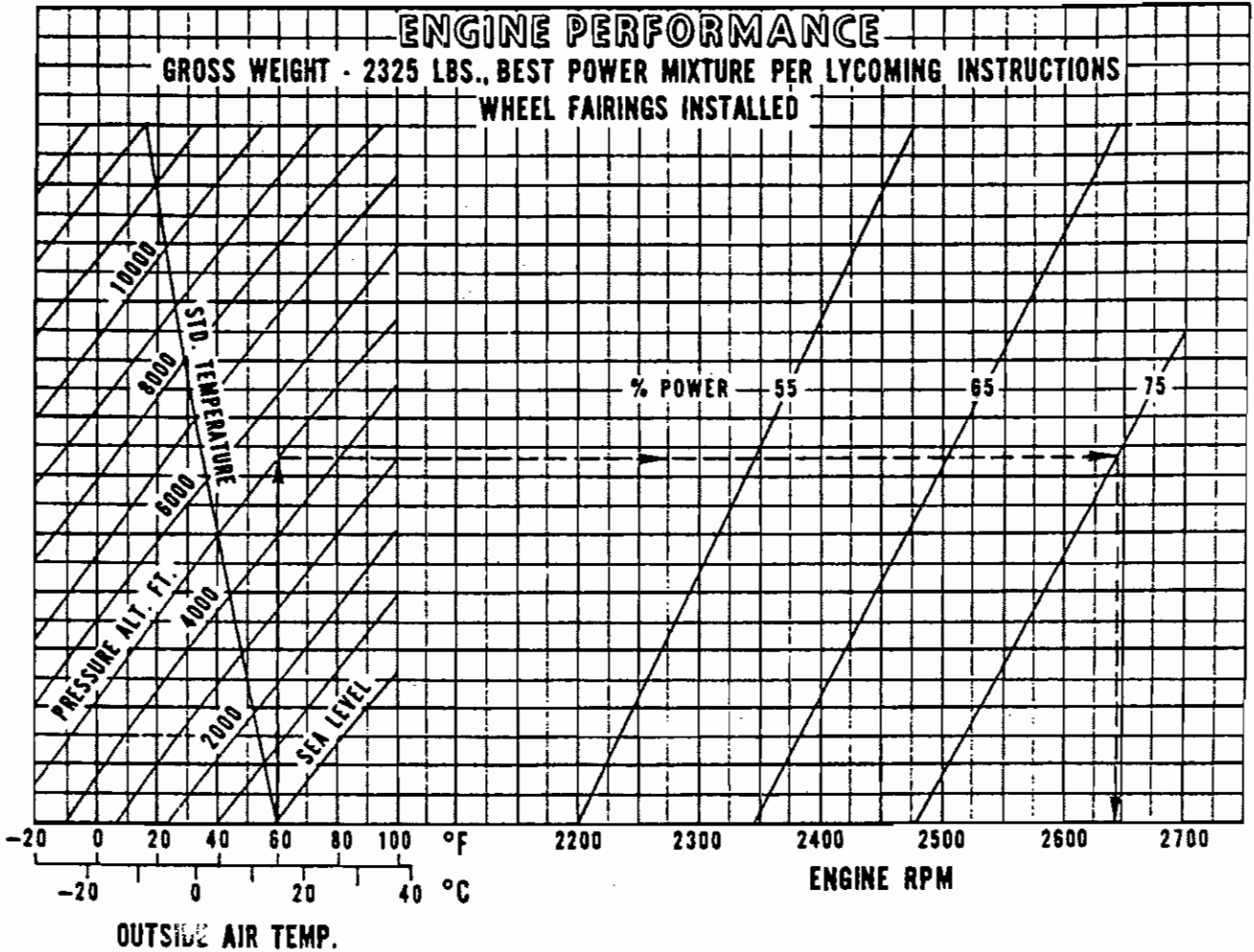

Example:

- Cruise pressure altitude: 5000 ft.
- Cruise OAT: 60°F
- Cruise power: 75%
- Engine RPM: 2645

ENGINE PERFORMANCE (SERIAL NOS. 28-7716001 THROUGH 7716323)

Figure 5-9

PA-28-161

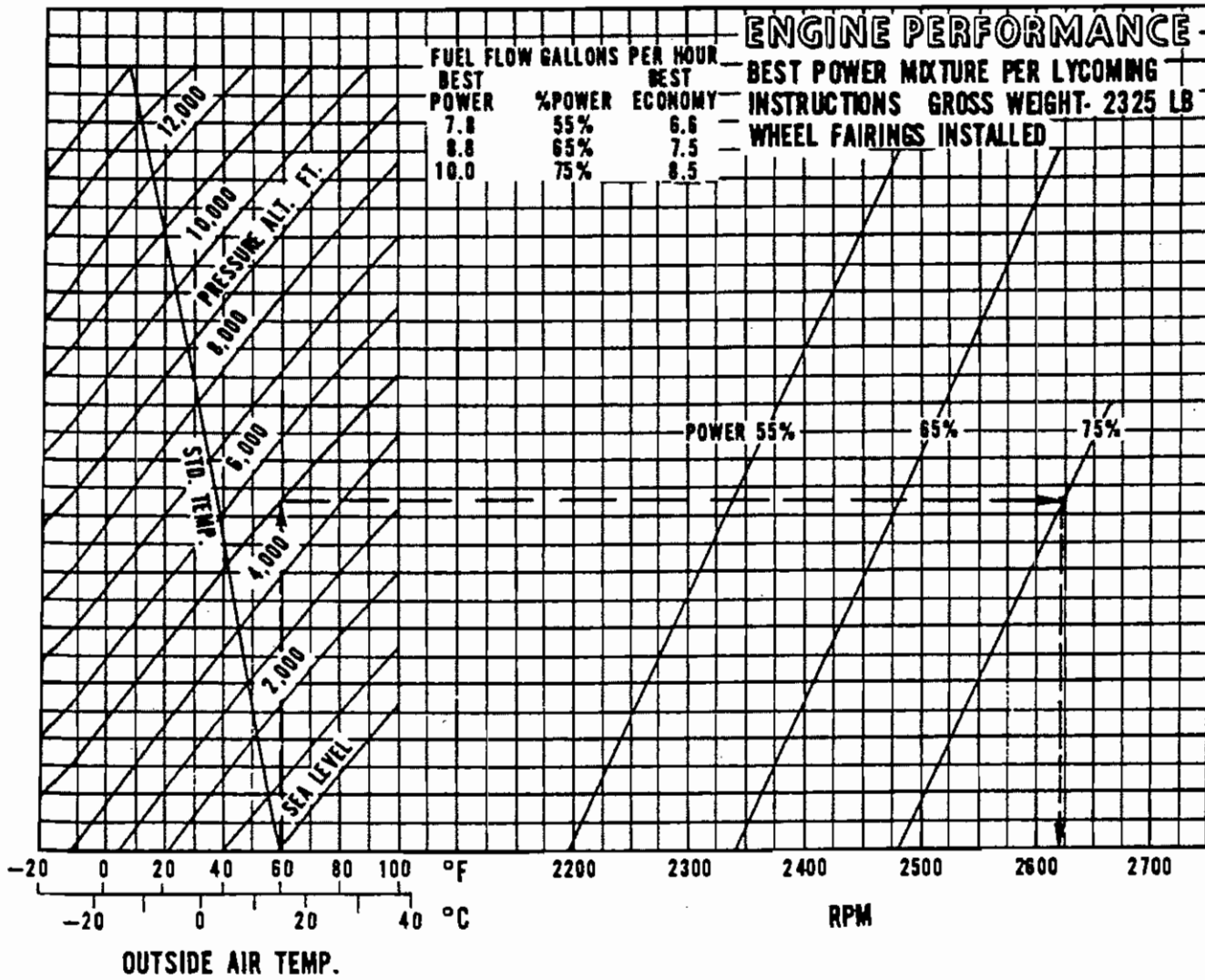

Example:
Cruise pressure altitude: 5000 ft.
Cruise OAT: 60°F
Cruise power: 75%
Engine RPM: 2620

ENGINE PERFORMANCE (SERIAL NOS. 28-7816001 AND UP)

Figure 5-10

PA-28-161

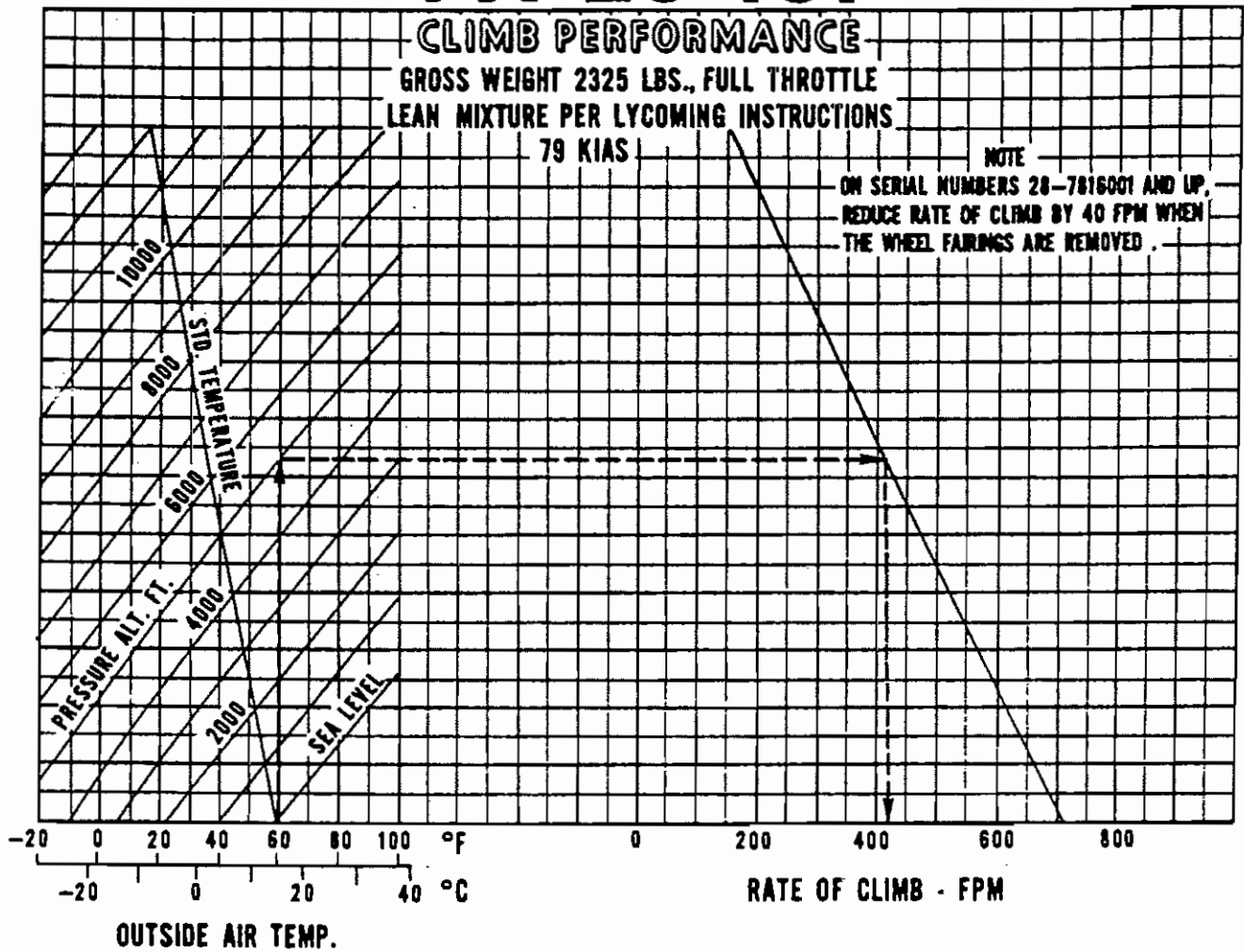

Example:

Climb pressure altitude: 5000 ft.

Climb OAT: 60°F

Rate of climb: 420 ft/min.

CLIMB PERFORMANCE

Figure 5-11

PA-28-161

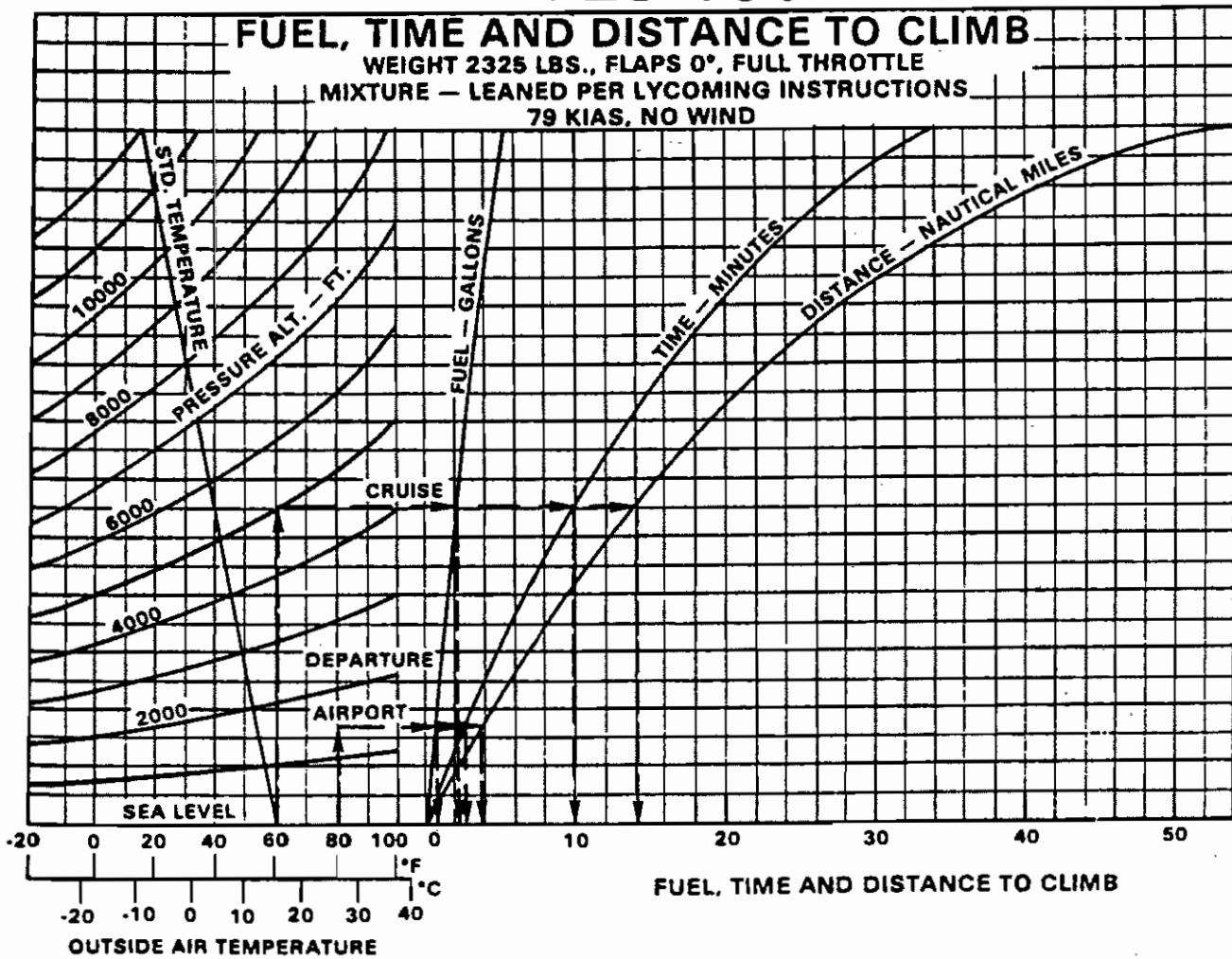

Example:

- Departure airport pressure altitude: 1500 ft.
- Departure airport temperature: 80°F (27°C)
- Cruise pressure altitude: 5000 ft.
- Cruise OAT: 60°F (16°C)
- Time to climb (10 min. minus 2.5 min.): 7.5 min.
- Distance to climb (13.5 miles minus 3.5 miles): 10 nautical miles
- Fuel to climb (2 gal. minus .5 gal.): 1.5 gal.

FUEL, TIME AND DISTANCE TO CLIMB

Figure 5-13

PA-28-161

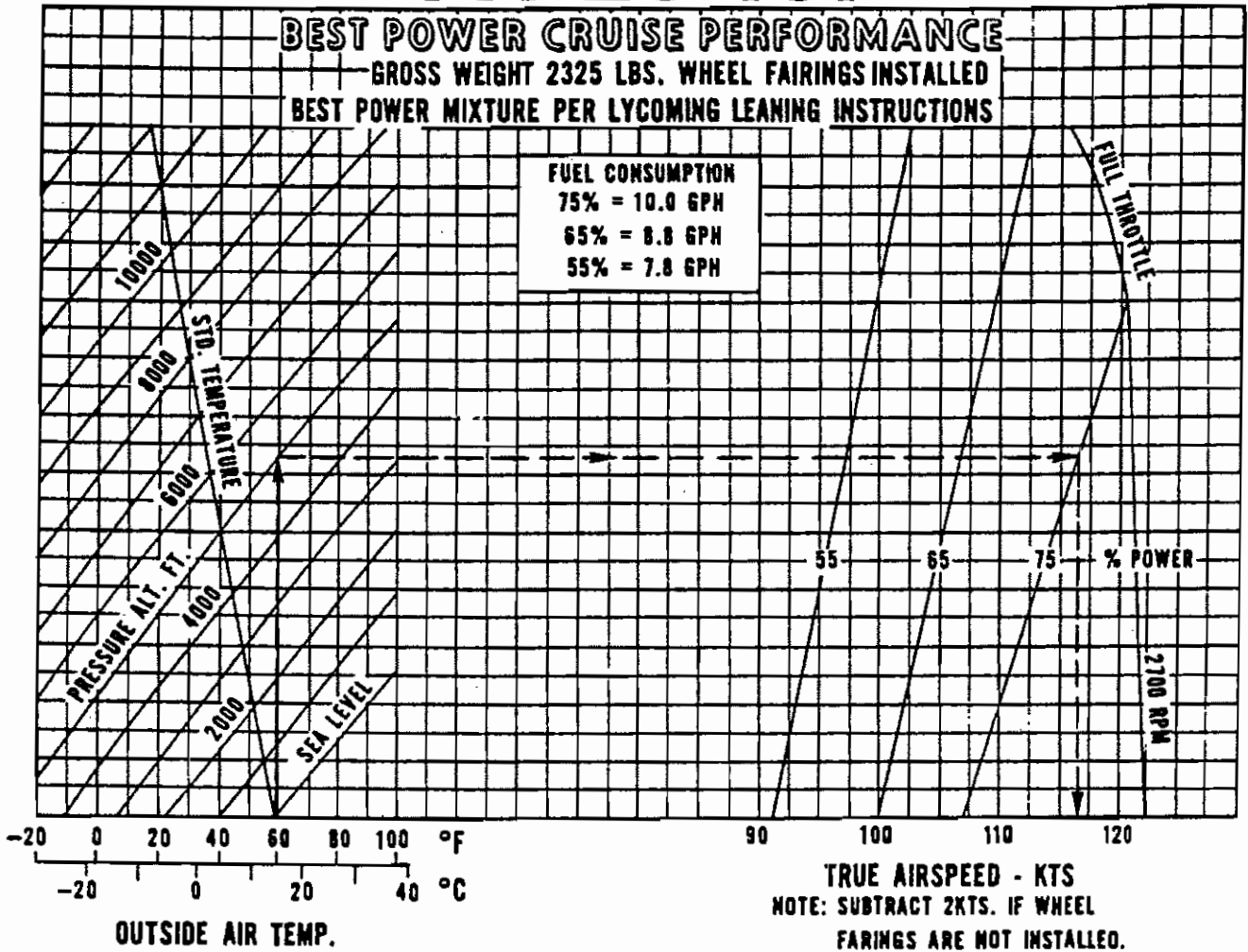

Example:

- Cruise pressure altitude: 5000 ft.
- Cruise OAT: 60°F
- Cruise power: 75% best power mixture
- Cruise speed: 116.5 KTS TAS

BEST POWER CRUISE PERFORMANCE (SERIAL NOS. 28-7716001 THROUGH 7716323)

Figure 5-15

PA-28-161

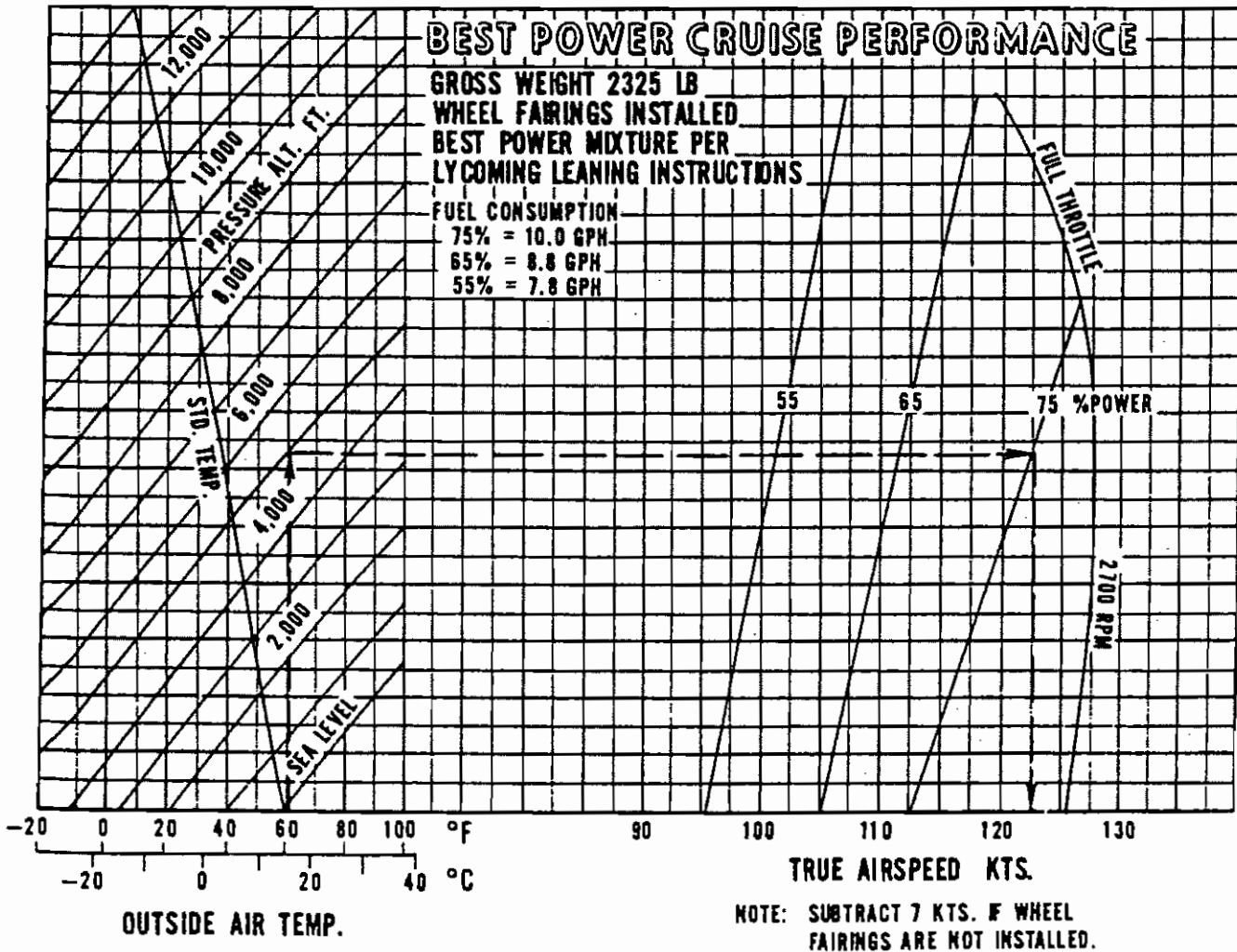

Example:

- Cruise pressure altitude: 5000 ft.
- Cruise OAT: 60°F
- Cruise power: 75% best power mixture
- Cruise speed: 122.5 KTS TAS

BEST POWER CRUISE PERFORMANCE (SERIAL NOS. 28-7816001 AND UP)

Figure 5-16

PA-28-161

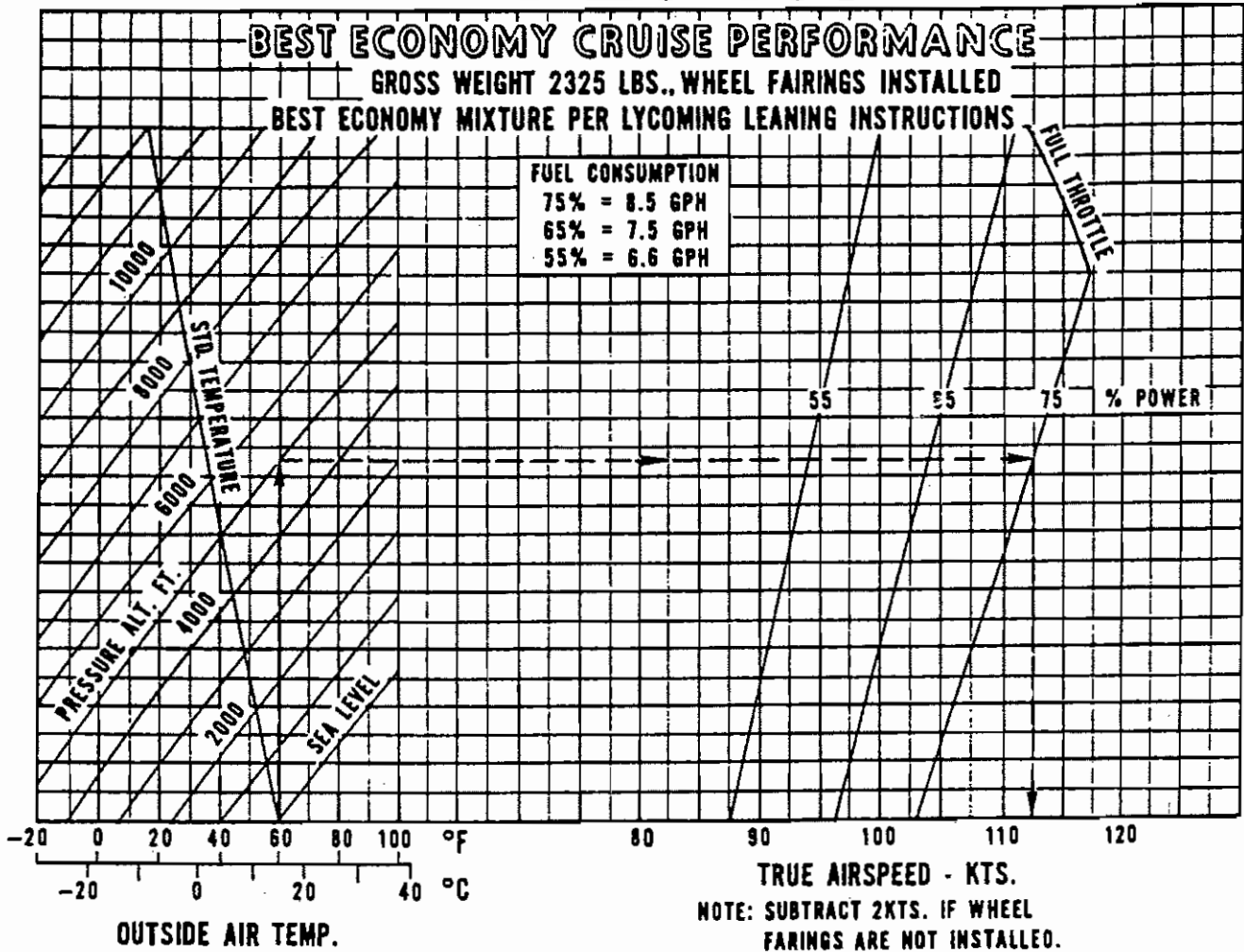

Example:

Cruise pressure altitude: 5000 ft.
 Cruise OAT: 60°F
 Cruise power: 75% best economy mixture
 Cruise speed: 112.5 KTS TAS

BEST ECONOMY CRUISE PERFORMANCE (SERIAL NOS. 28-7716001 THROUGH 7716323)

Figure 5-17

PA-28-161

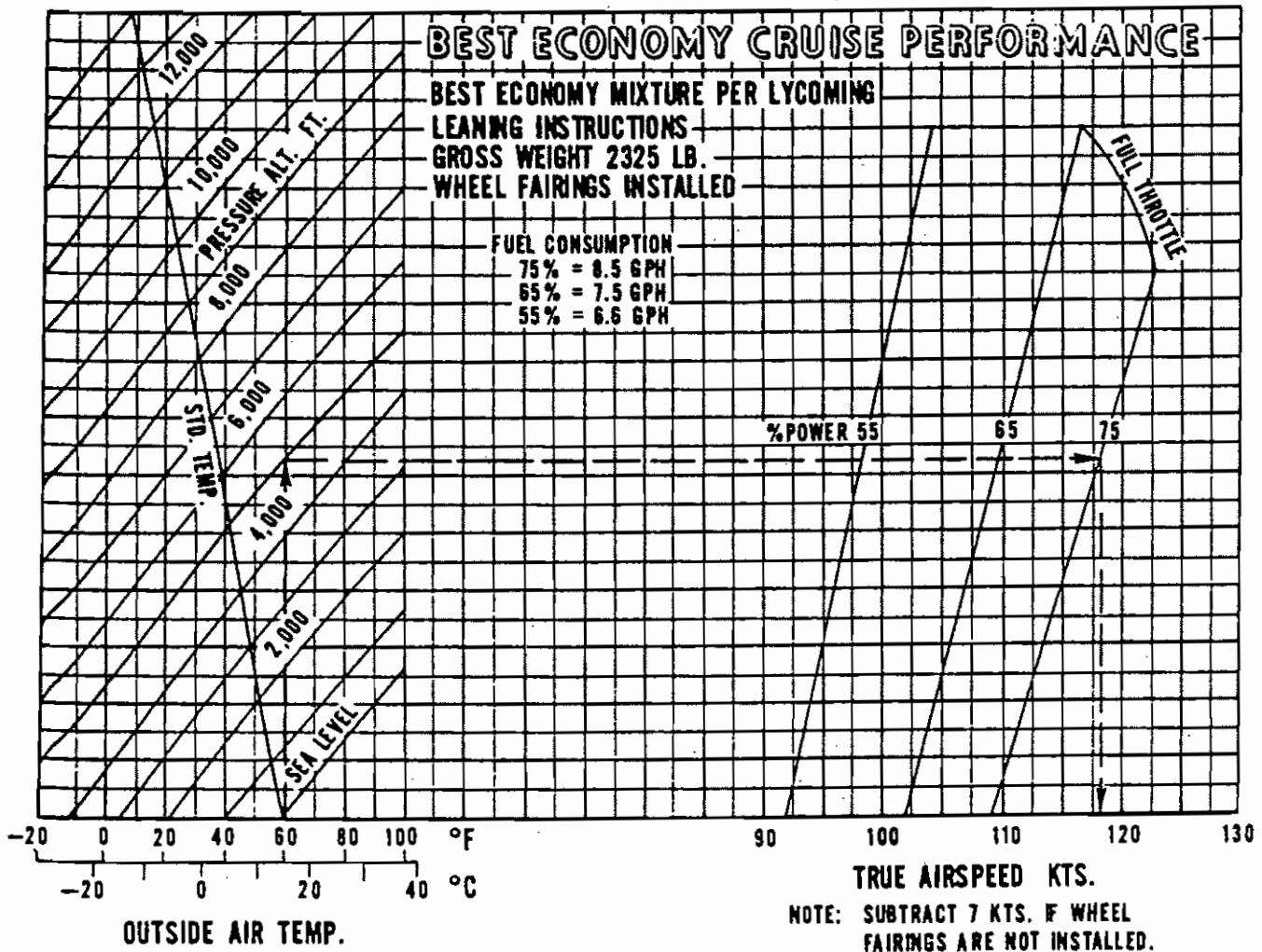

Example:
Cruise pressure altitude: 5000 ft.
Cruise OAT: 60°F
Cruise power: 75% best power mixture
Cruise speed: 118 KTS TAS

BEST ECONOMY CRUISE PERFORMANCE (SERIAL NOS. 28-7816001 AND UP)

Figure 5-18

PA-28-161

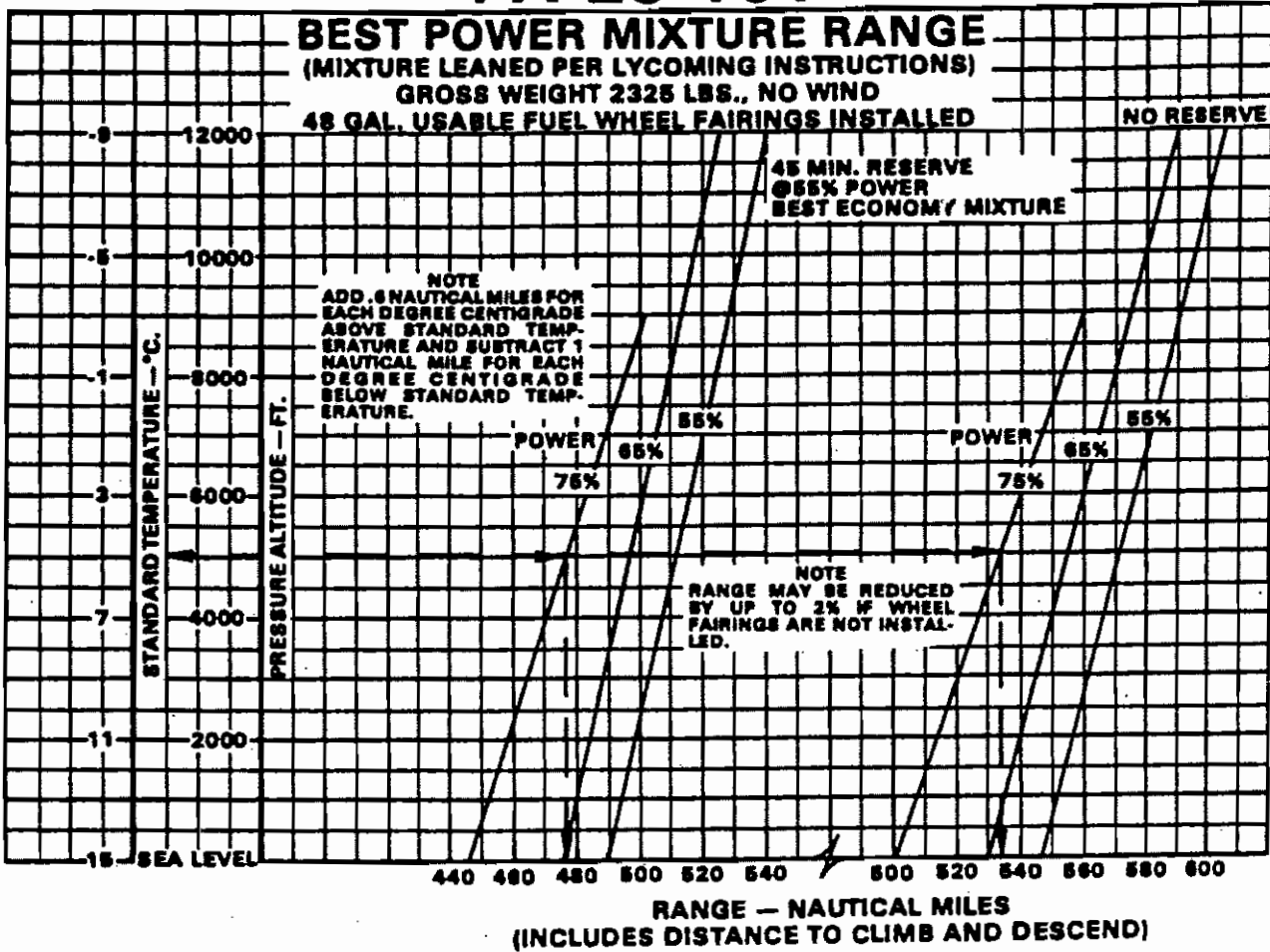

Example:

- Cruise pressure altitude: 5000 ft.
- Cruise OAT: 16°C (11°C above standard)
- Cruise power: 75% best power mixture
- Range w/45 min. reserve @ 55% power: $476 + (.6 \times 11) = 482.6$ nautical miles
- Range w/no reserve: $533 + (.6 \times 11) = 539.6$ nautical miles

BEST POWER MIXTURE RANGE (SERIAL NOS. 28-7716001 THROUGH 7716323)

Figure 5-19

PA-28-161

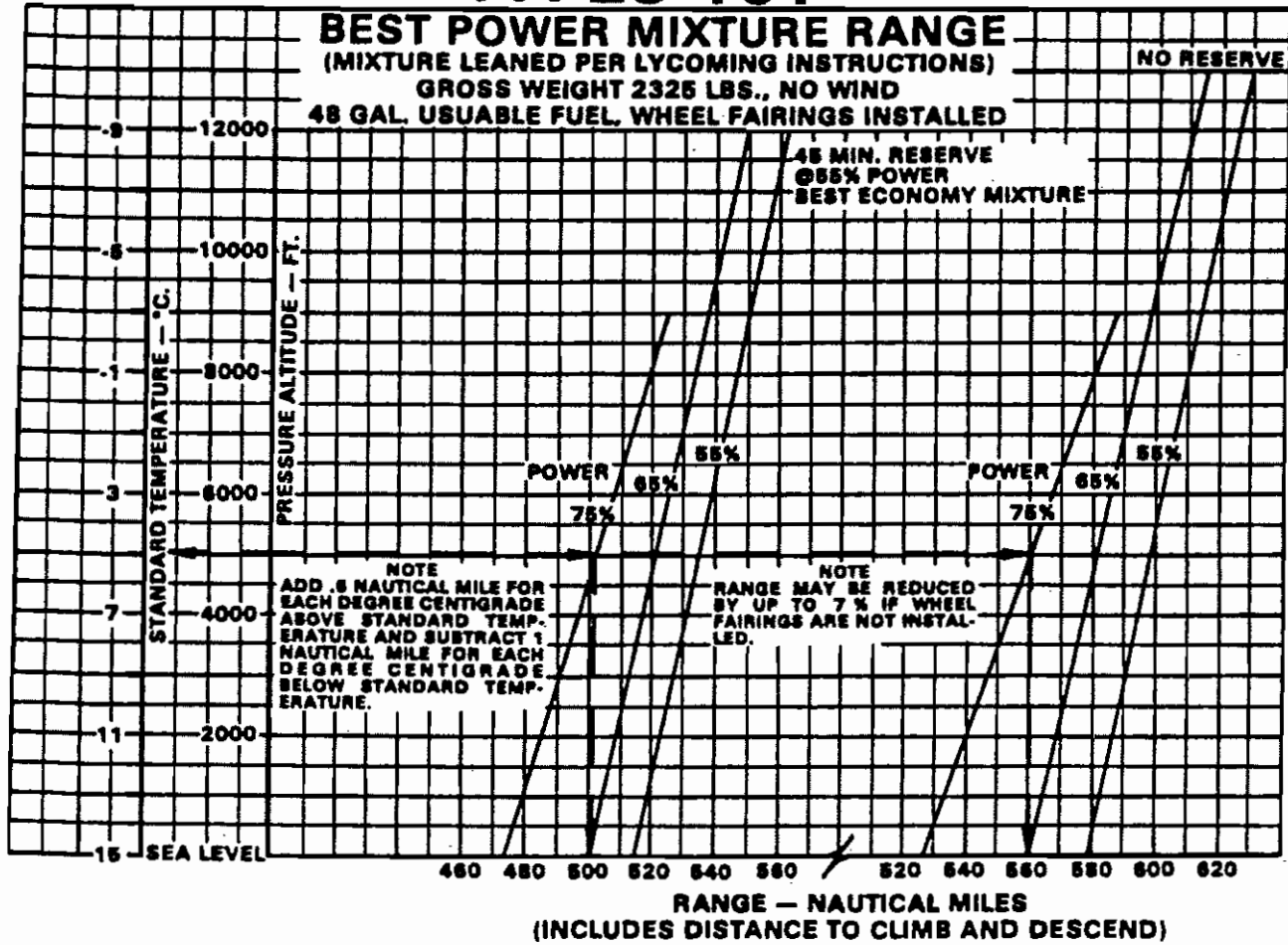

example:

- Cruise pressure altitude: 5000 ft.
- Cruise OAT: 16°C (11°C above standard)
- Cruise power: 75% best power mixture
- Range w/45 min. reserve @ 55% power: $501 + (.6 \times 11) = 507.6$ nautical miles
- Range w/no reserve: $561 + (.6 \times 11) = 567.6$ nautical miles.

BEST POWER MIXTURE RANGE (SERIAL NOS. 28-7816001 AND UP)

Figure 5-20

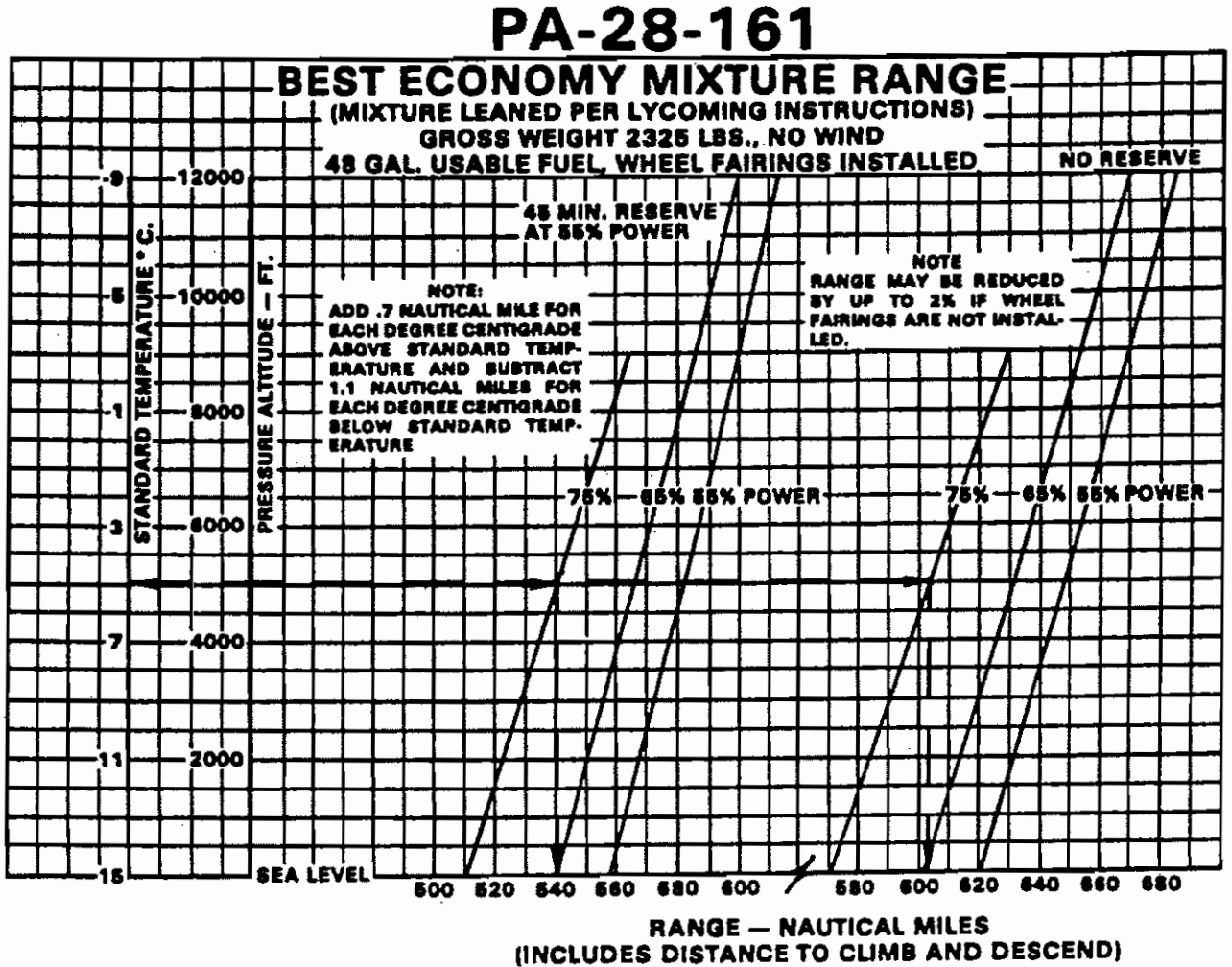

Example:

- Cruise pressure altitude: 5000 ft.
- Cruise OAT: 16°C (11°C above standard)
- Cruise power: 75% best economy mixture
- Range w/45 min. reserve @ 55% power: $540 + (.7 \times 11) = 547.7$ nautical miles
- Range w/no reserve: $602 + (.7 \times 11) = 609.7$ nautical miles

BEST ECONOMY MIXTURE RANGE (SERIAL NOS. 28-7716001 THROUGH 7716323)

Figure 5-21

PA-28-161

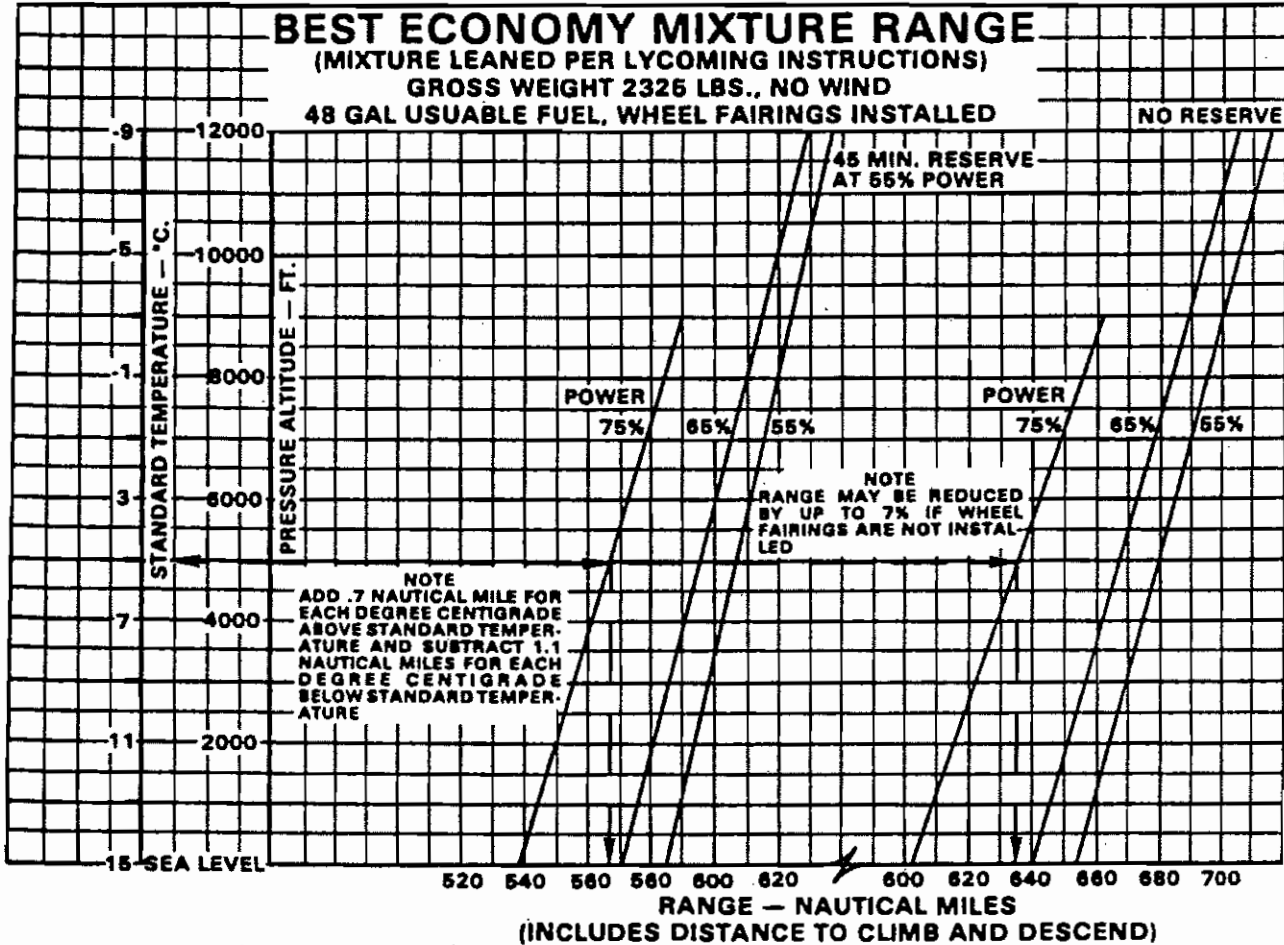

Example:

- Cruise pressure altitude: 5000 ft.
- Cruise OAT: 16°C (11°C above standard)
- Cruise power: 75% best economy mixture
- Range w/ 45 min. reserve @ 55% power: $567 + (.7 \times 11) = 574.7$ nautical miles
- Range w/no reserve: $635 + (.7 \times 11) = 642.7$ nautical miles

BEST ECONOMY MIXTURE RANGE (SERIAL NOS. 28-7816001 AND UP)

Figure 5-22

PA-28-161

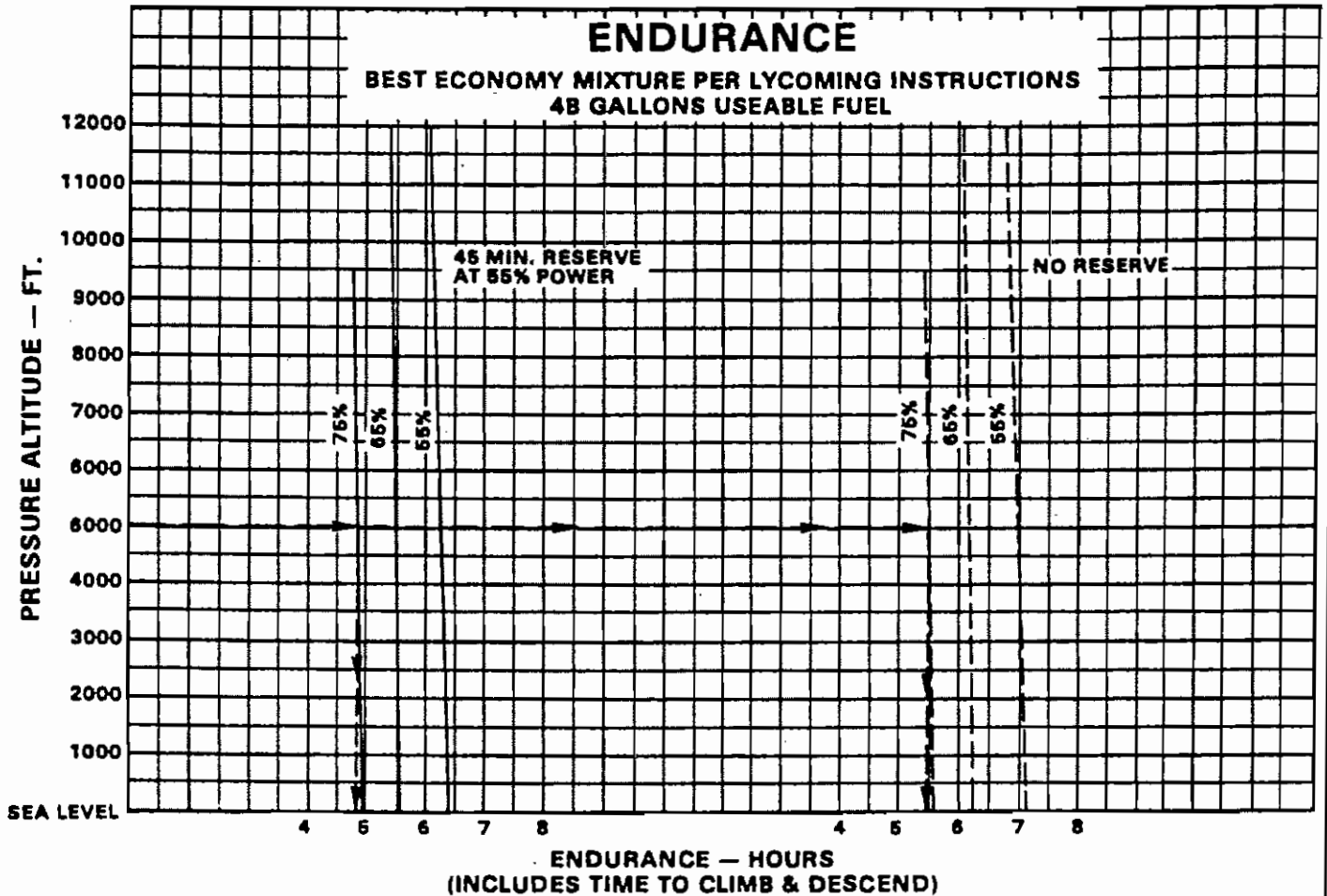

Example:

- Cruise pressure altitude: 5000 ft.
- Cruise power: 75% best economy mixture
- Endurance w/45 min. reserve @ 55% power: 4.85 hrs.
- Endurance w/no reserve: 5.45 hrs.

ENDURANCE

Figure 5-23

PA-28-161

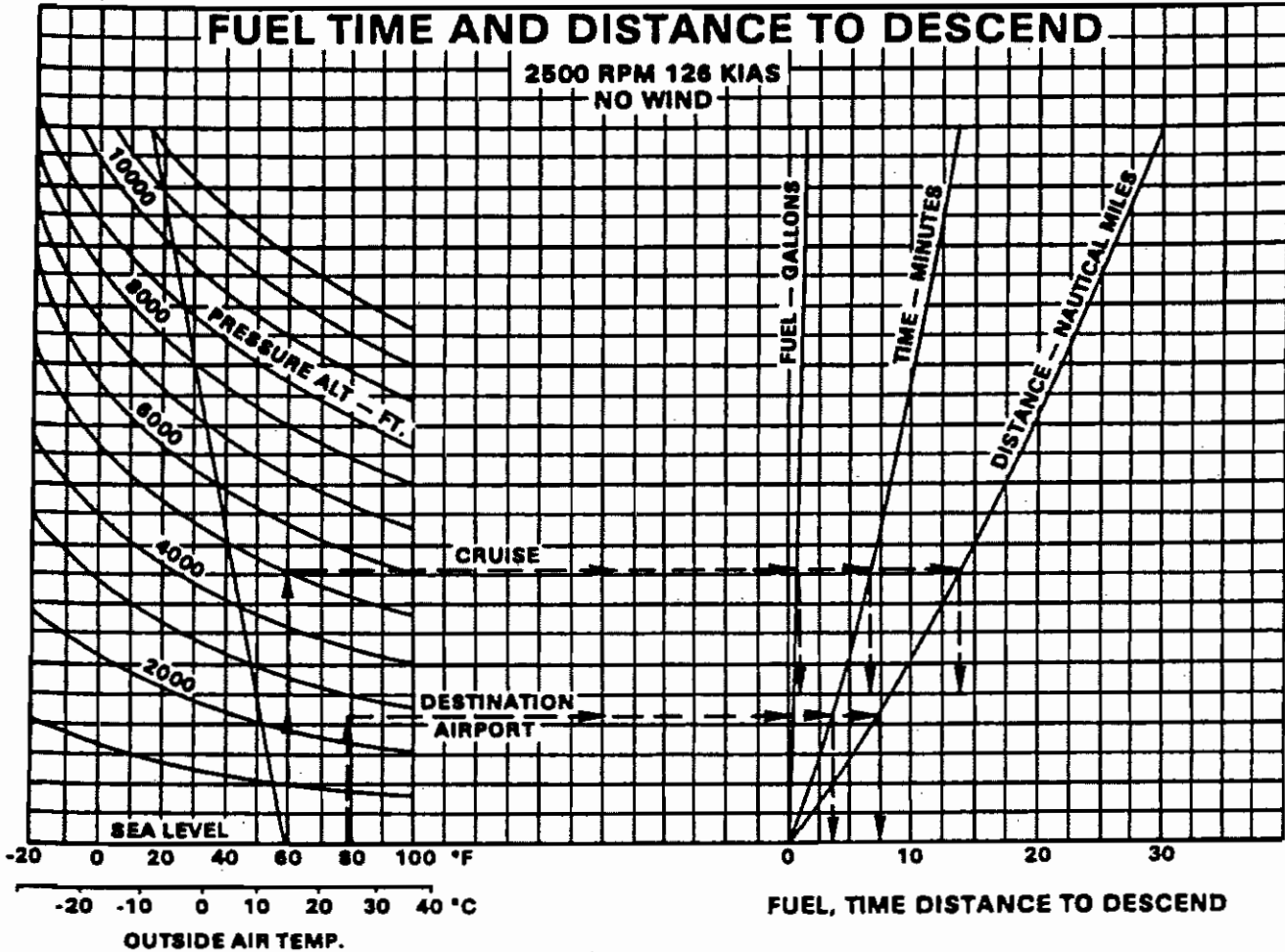

Example:

- Destination airport pressure altitude: 2500 ft.
- Destination airport temperature: 75°F (24°C)
- Cruise pressure altitude: 5000 ft.
- Cruise OAT: 60°F (16°C)
- Time to descend (6.5 min. minus 3.5 min.): 3 min.
- Distance to descend (14 miles minus 7.5 miles): 6.5 nautical miles
- Fuel to descend: (1 gal. minus .5 gal.): .5 gal.

FUEL, TIME AND DISTANCE TO DESCEND

Figure 5-25

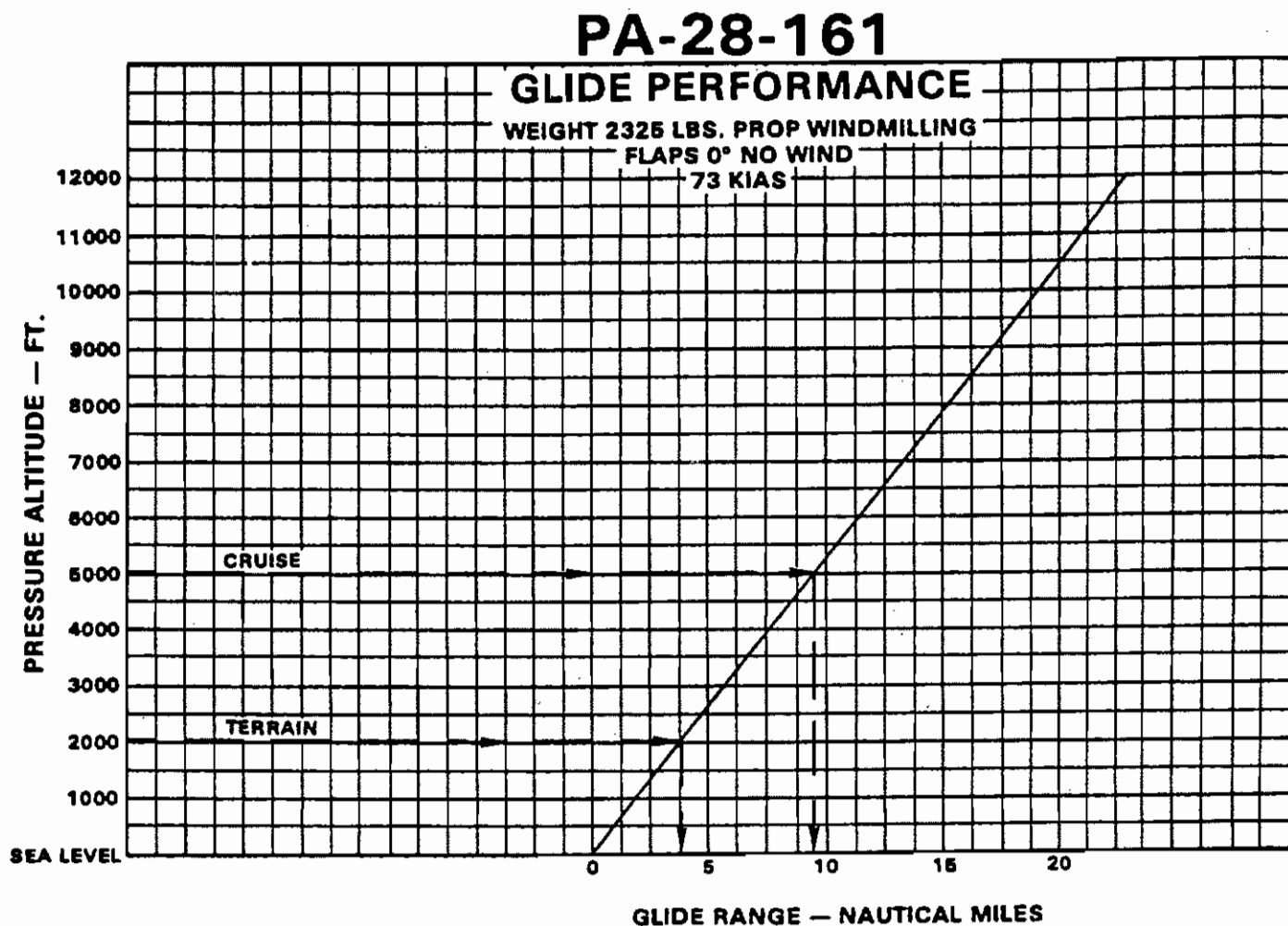

Example:

Cruise pressure altitude: 5000 ft.

Terrain pressure altitude: 2000 ft.

Glide distance (9.5 miles minus 3.8 miles): 5.7 nautical miles

GLIDE PERFORMANCE

Figure 5-27

PA-28-161

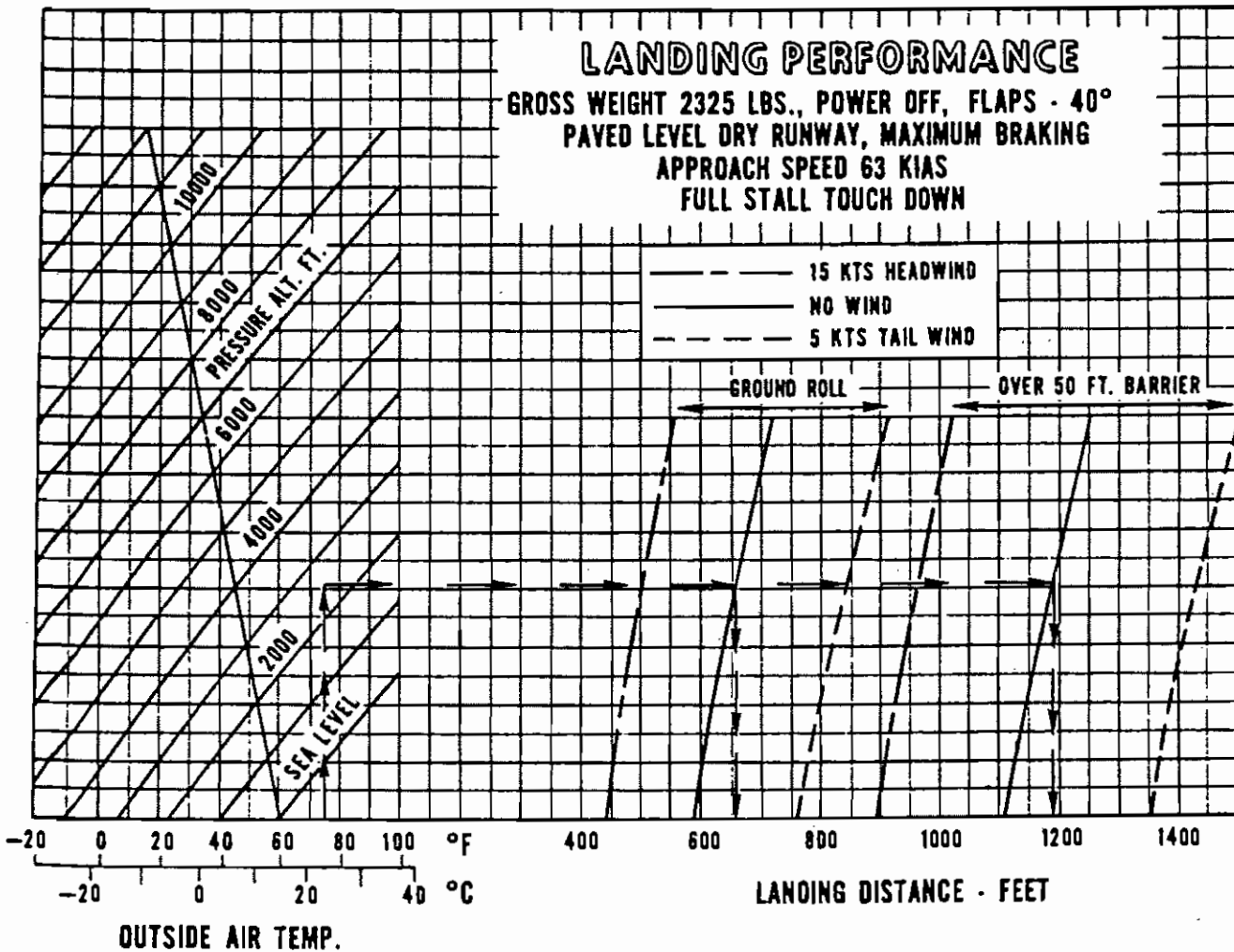

Example:
 Destination airport pressure altitude: 2500 ft.
 Destination airport temperature: 75°F
 Destination airport wind: 0 KTS
 Ground roll: 660 ft.
 Distance over 50 ft. barrier: 1190 ft.

LANDING PERFORMANCE
Figure 5-29

TABLE OF CONTENTS

SECTION 6

WEIGHT AND BALANCE

Paragraph No.		Page No.
6.1	General	6-1
6.3	Airplane Weighing Procedure	6-3
6.5	Weight and Balance Data and Record	6-6
6.7	Weight and Balance Determination for Flight	6-11
6.9	Equipment List	6-17
(a)	Propeller and Propeller Accessories	6-17
(b)	Engine and Engine Accessories	6-19
(c)	Landing Gear and Brakes	6-21
(d)	Electrical Equipment	6-23
(e)	Instruments	6-25
(f)	Miscellaneous	6-27
(g)	Engine and Engine Accessories (Optional Equipment)	6-29
(h)	Propeller and Propeller Accessories (Optional Equipment)	6-31
(i)	Landing Gear and Brakes (Optional Equipment)	6-33
(j)	Electrical Equipment (Optional Equipment)	6-35
(k)	Instruments (Optional Equipment)	6-37
(l)	Autopilots (Optional Equipment)	6-39
(m)	Radio Equipment (Optional Equipment)	6-41
(n)	Miscellaneous (Optional Equipment)	6-53



**SECTION 6
WEIGHT AND BALANCE**

6.1 GENERAL

In order to achieve the performance and flying characteristics which are designed into the airplane, it must be flown with the weight and center of gravity (C.G.) position within the approved operating range (envelope). Although the airplane offers flexibility of loading, it cannot be flown with the maximum number of adult passengers, full fuel tanks and maximum baggage. With the flexibility comes responsibility. The pilot must insure that the airplane is loaded within the loading envelope before he makes a takeoff.

Misloading carries consequences for any aircraft. An overloaded airplane will not take off, climb or cruise as well as a properly loaded one. The heavier the airplane is loaded, the less climb performance it will have.

Center of gravity is a determining factor in flight characteristics. If the C.G. is too far forward in any airplane, it may be difficult to rotate for takeoff or landing. If the C.G. is too far aft, the airplane may rotate prematurely on takeoff or tend to pitch up during climb. Longitudinal stability will be reduced. This can lead to inadvertent stalls and even spins; and spin recovery becomes more difficult as the center of gravity moves aft of the approved limit.

A properly loaded airplane, however, will perform as intended. Before the airplane is delivered, it is weighed, and a basic empty weight and C.G. location is computed (basic empty weight consists of the standard empty weight of the airplane plus the optional equipment). Using the basic empty weight and C.G. location, the pilot can easily determine the weight and C.G. position for the loaded airplane by computing the total weight and moment and then determining whether they are within the approved envelope.

The basic empty weight and C.G. location are recorded in the Weight and Balance Data Form (Figure 6-5) and the Weight and Balance Record (Figure 6-7). The current values should always be used. Whenever new equipment is added or any modification work is done, the mechanic responsible for the work is required to compute a new basic empty weight and C.G. position and to write these in the Aircraft Log Book and the Weight and Balance Record. The owner should make sure that it is done.

A weight and balance calculation is necessary in determining how much fuel or baggage can be boarded so as to keep within allowable limits. Check calculations prior to adding fuel to insure against improper loading.

The following pages are forms used in weighing an airplane in production and in computing basic empty weight, C.G. position, and useful load. Note that the useful load includes usable fuel, baggage, cargo and passengers. Following this is the method for computing takeoff weight and C.G.

THIS PAGE INTENTIONALLY LEFT BLANK

6.3 AIRPLANE WEIGHING PROCEDURE

At the time of delivery, Piper Aircraft Corporation provides each airplane with the basic empty weight and center of gravity location. This data is supplied by Figure 6-5.

The removal or addition of equipment or airplane modifications can affect the basic empty weight and center of gravity. The following is a weighing procedure to determine this basic empty weight and center of gravity location:

(a) Preparation

- (1) Be certain that all items checked in the airplane equipment list are installed in the proper location in the airplane.
- (2) Remove excessive dirt, grease, moisture, foreign items such as rags and tools from the airplane before weighing.
- (3) Defuel airplane. Then open all fuel drains until all remaining fuel is drained. Operate engine on each tank until all undrainable fuel is used and engine stops. Then add the unusable fuel (2.0 gallons total, 1.0 gallons each wing).

CAUTION

Whenever the fuel system is completely drained and fuel is replenished, it will be necessary to run the engine for a minimum of three minutes at 1000 RPM on each tank to insure no air exists in the fuel supply lines.

- (4) Fill with oil to full capacity.
 - (5) Place pilot and copilot seats in fourth (4th) notch, aft of forward position. Put flaps in the fully retracted position and all control surfaces in the neutral position. Tow bar should be in the proper location and all entrance and baggage doors closed.
 - (6) Weigh the airplane inside a closed building to prevent errors in scale readings due to wind.
- (b) Leveling
- (1) With airplane on scales, block main gear oleo pistons in the fully extended position.
 - (2) Level airplane (refer to Figure 6-3) deflating nose wheel tire, to center bubble on level.

(c) Weighing - Airplane Basic Empty Weight

- (1) With the airplane level and brakes released, record the weight shown on each scale. Deduct the tare, if any, from each reading.

Scale Position and Symbol	Scale Reading	Tare	Net Weight
Nose Wheel (N)			
Right Main Wheel (R)			
Left Main Wheel (L)			
Basic Empty Weight, as Weighed (T)	—	—	

WEIGHING FORM

Figure 6-1

(d) Basic Empty Weight Center of Gravity

- (1) The following geometry applies to the PA-28-161 airplane when it is level. Refer to Leveling paragraph 6.3 (b).

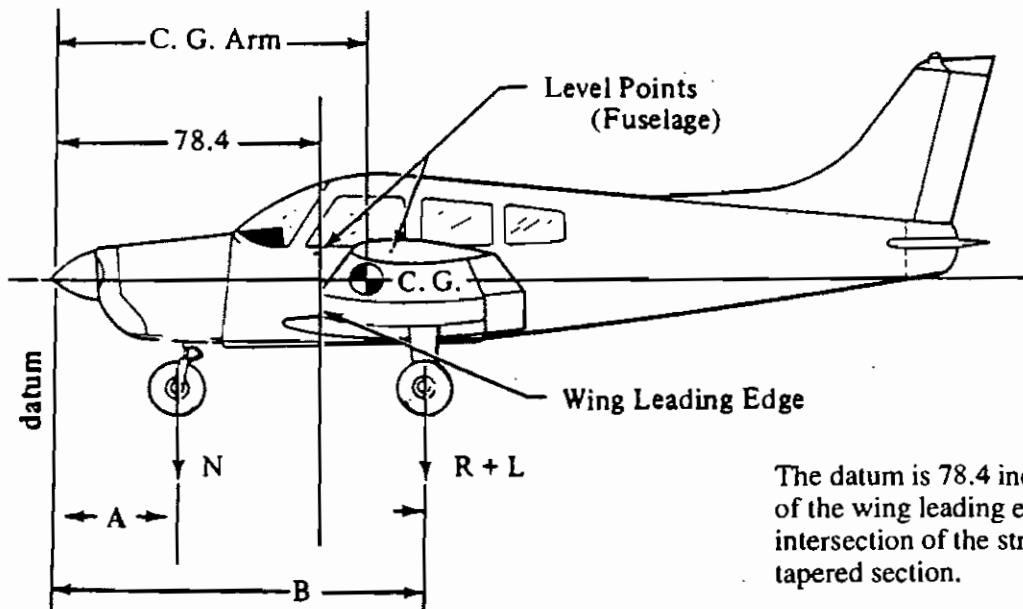

A = 30.9

B = 109.7

LEVELING DIAGRAM

Figure 6-3

- (2) The basic empty weight center of gravity (as weighed including optional equipment, full oil and unusable fuel) can be determined by the following formula:

$$\text{C.G. Arm} = \frac{N(A) + (R+L)(B)}{T} \text{ inches}$$

Where: $T = N + R + L$

6.5 WEIGHT AND BALANCE DATA AND RECORD

The Basic Empty Weight, Center of Gravity Location and Useful Load listed in Figure 6-5 are for the airplane as delivered from the factory. These figures apply only to the specific airplane serial number and registration number shown.

The basic empty weight of the airplane as delivered from the factory has been entered in the Weight and Balance Record (Figure 6-7). This form is provided to present the current status of the airplane basic empty weight and a complete history of previous modifications. Any change to the permanently installed equipment or modification which affects weight or moment must be entered in the Weight and Balance Record.

MODEL PA-28-161 CHEROKEE WARRIOR II

Airplane Serial Number _____

Registration Number _____

Date _____

AIRPLANE BASIC EMPTY WEIGHT

Item	Weight (Lbs)	x	C.G. Arm (Inches Aft of Datum)	=	Moment (In-Lbs)
Standard Empty Weight*	Actual Computed				
Optional Equipment					
Basic Empty Weight					

*The standard empty weight includes full oil capacity and 2.0 gallons of unusable fuel.

AIRPLANE USEFUL LOAD - NORMAL CATEGORY OPERATION

(Gross Weight) - (Basic Empty Weight) = Useful Load

Normal Category: (2325 lbs) - (lbs) = lbs.

Utility Category: (2020 lbs) - (lbs) = lbs.

THIS BASIC EMPTY WEIGHT, C.G. AND USEFUL LOAD ARE FOR THE AIRPLANE AS LICENSED AT THE FACTORY. REFER TO APPROPRIATE AIRCRAFT RECORD WHEN ALTERATIONS HAVE BEEN MADE.

WEIGHT AND BALANCE DATA FORM

Figure 6-5

**SECTION 6
WEIGHT AND BALANCE**

**PIPER AIRCRAFT CORPORATION
PA-28-161, CHEROKEE WARRIOR II**

THIS PAGE INTENTIONALLY LEFT BLANK

PA-28-161	Item No.	Serial Number	Registration Number				Page Number	
			Weight Change				Running Basic Empty Weight	
			Added (+)		Removed (-)		Wt.	Moment
Date	In	Out	Wt. (Lb.)	Arm (In.)	Moment /100	Wt. (Lb.)	Moment /100	
		As Delivered						

WEIGHT AND BALANCE RECORD
Figure 6-7

PA-28-161	Date	Item No.		Serial Number	Registration Number						Page Number				
		In	Out		Description of Article or Modification	Weight Change Added (+)			Weight Change Removed (-)			Running Basic Empty Weight			
						Wt. (Lb.)	Arm (In.)	Moment /100	Wt. (Lb.)	Arm (In.)	Moment /100	Wt. (Lb.)	Moment /100		
				As Delivered											

WEIGHT AND BALANCE RECORD (cont)
Figure 6-7 (cont)

6.7 WEIGHT AND BALANCE DETERMINATION FOR FLIGHT

- (a) Add the weight of all items to be loaded to the basic empty weight.
- (b) Use the Loading Graph (Figure 6-13) to determine the moment of all items to be carried in the airplane.
- (c) Add the moment of all items to be loaded to the basic empty weight moment.
- (d) Divide the total moment by the total weight to determine the C.G. location.
- (e) By using the figures of item (a) and item (d) (above), locate a point on the C.G. range and weight graph (Figure 6-15). If the point falls within the C.G. envelope, the loading meets the weight and balance requirements.

	Weight (Lbs)	Arm Aft Datum (Inches)	Moment (In-Lbs)
Basic Empty Weight			
Pilot and Front Passenger	340.0	80.5	27370
Passengers (Rear Seats)*	340.0	118.1	40154
Fuel (48 Gallon Maximum)		95.0	
Baggage* (200 Lbs. Maximum)		142.8	
Total Loaded Airplane			

The center of gravity (C.G.) of this sample loading problem is at _____ inches aft of the datum line. Locate this point () on the C.G. range and weight graph. Since this point falls within the weight - C.G. envelope, this loading meets the weight and balance requirements.

IT IS THE RESPONSIBILITY OF THE PILOT AND AIRCRAFT OWNER TO INSURE THAT THE AIRPLANE IS LOADED PROPERLY.

*Utility Category Operation - No baggage or aft passengers allowed.

SAMPLE LOADING PROBLEM (NORMAL CATEGORY)

Figure 6-9

**SECTION 6
WEIGHT AND BALANCE**

**PIPER AIRCRAFT CORPORATION
PA-28-161, CHEROKEE WARRIOR II**

	Weight (Lbs)	Arm Aft Datum (Inches)	Moment (In-Lbs)
Basic Empty Weight			
Pilot and Front Passenger		80.5	
Passenger (Rear Seats)*		118.1	
Fuel (48 Gallon Maximum)		95.0	
Baggage* (200 Lbs. Maximum)		142.8	
Total Loaded Airplane			

Totals must be within approved weight and C.G. limits. It is the responsibility of the airplane owner and the pilot to insure that the airplane is loaded properly. The Basic Empty Weight C.G. is noted on the Weight and Balance Data Form (Figure 6-5). If the airplane has been altered, refer to the Weight and Balance Record for this information.

*Utility Category Operation - No baggage or aft passengers allowed.

WEIGHT AND BALANCE LOADING FORM

Figure 6-11

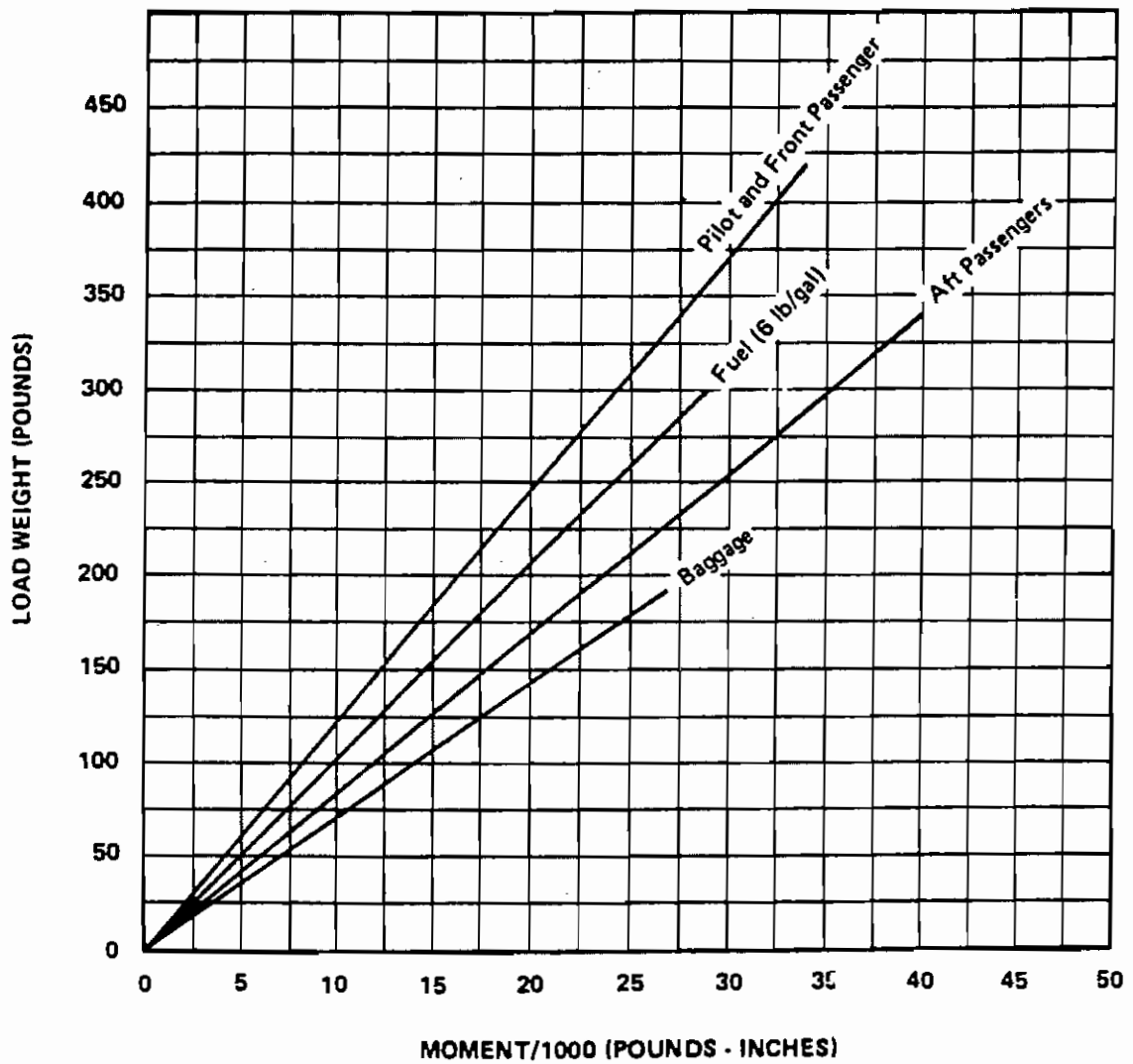

LOADING GRAPH

Figure 6-13

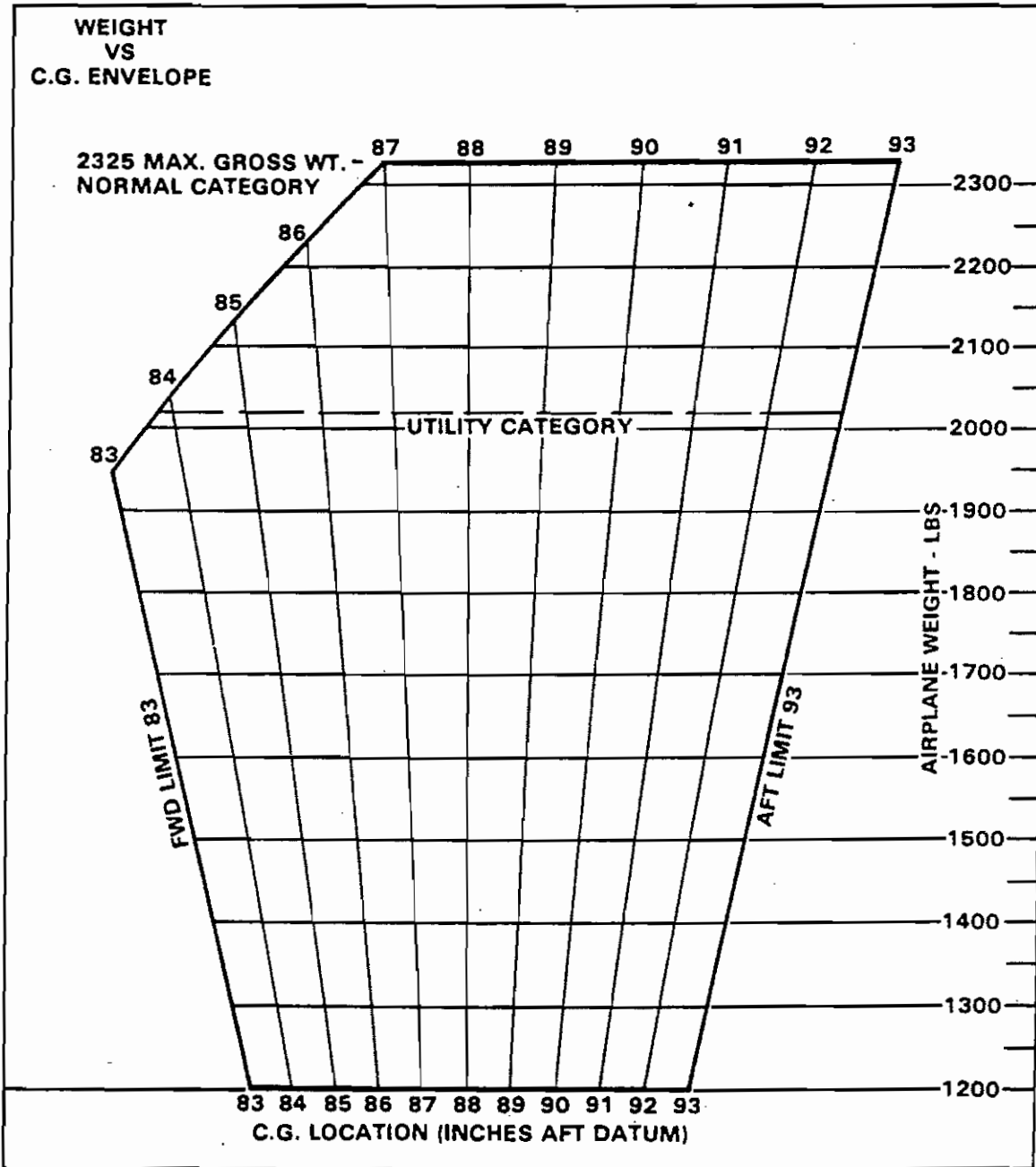

C. G. RANGE AND WEIGHT

Figure 6-15

6.8 INSTRUCTIONS FOR USING THE WEIGHT AND BALANCE PLOTTER.

This plotter is provided to enable the pilot quickly and conveniently to:

- (a) Determine the total weight and C.G. position.
- (b) Decide how to change his load if his first loading is not within the allowable envelope.

Heat can warp or ruin the plotter if it is left in the sunlight. Replacement plotters may be purchased from Piper dealers and distributors.

When the airplane is delivered, the basic weight and basic C.G. will be recorded on the computer. These should be changed any time the basic weight or C.G. location is changed.

The plotter enables the user to add weights and corresponding moments graphically. The effect of adding or disposing of useful load can easily be seen. The plotter does not cover the situation where cargo is loaded in locations other than on the seats or in the baggage compartments.

Brief instructions are given on the plotter itself. To use it, first plot a point on the grid to locate the basic weight and C.G. location. This can be put on more or less permanently because it will not change until the airplane is modified. Next, position the zero weight end of any one of the loading slots over this point. Using a pencil, draw a line along the slot to the weight which will be carried in that location. Then position the zero weight end of the next slot over the end of this line and draw another line representing the weight which will be located in this second position. When all the loads have been drawn in this manner, the final end of the segmented line locates the total load and the C.G. position of the airplane for takeoff. If this point is not within the allowable envelope it will be necessary to remove fuel, baggage or passengers and/or to rearrange baggage and passengers to get the final point to fall within the envelope.

Fuel burn-off does not significantly affect the center of gravity.

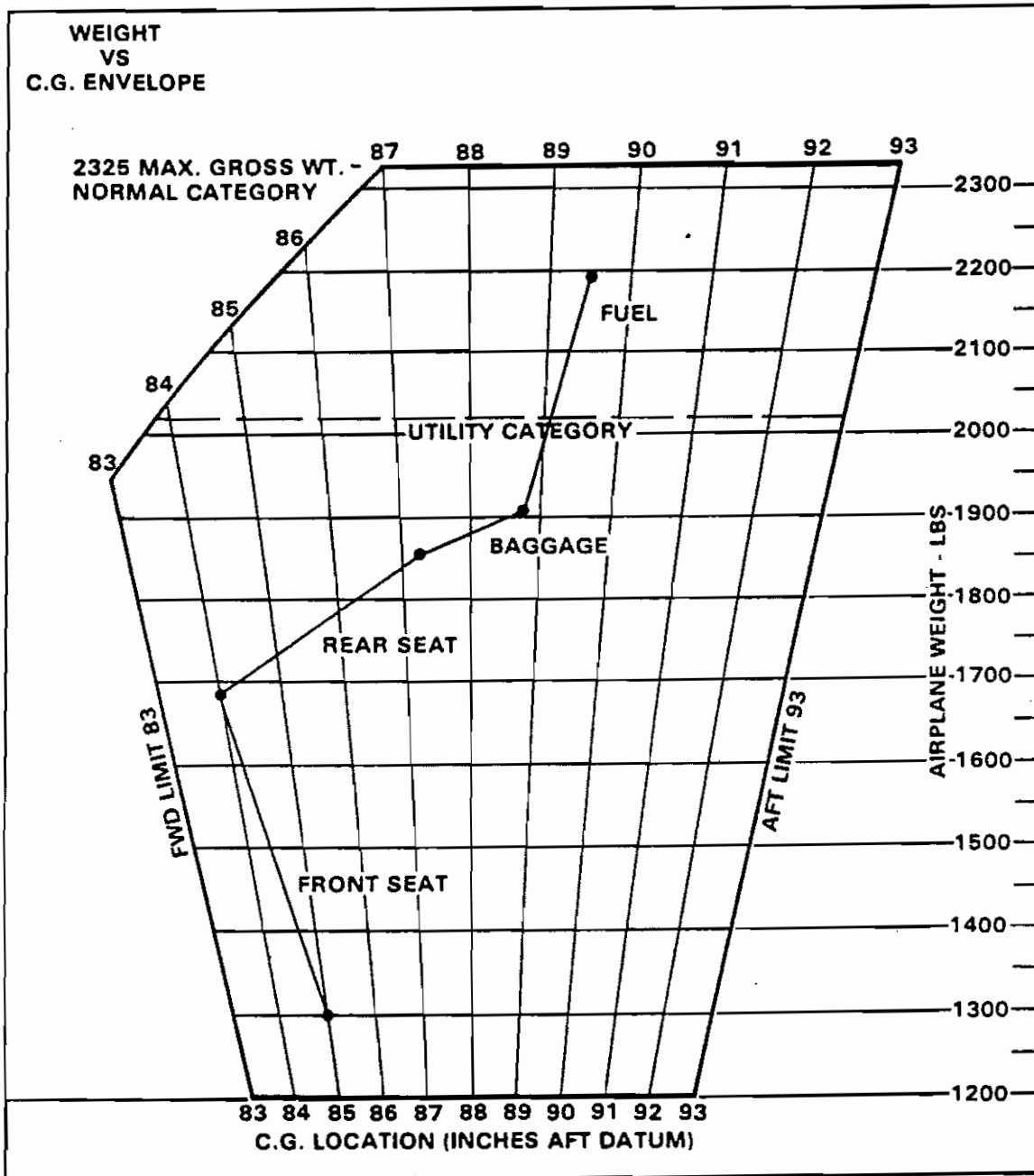

SAMPLE PROBLEM

SAMPLE PROBLEM

A sample problem will demonstrate the use of the weight and balance plotter.

Assume a basic weight and C.G. location of 1300 pounds at 85.00 inches respectively. We wish to carry a pilot and 3 passengers. Two men weighing 180 and 200 pounds will occupy the front seats, and two children weighing 80 and 100 pounds will ride in the rear. Two suitcases weighing 25 pounds and 20 pounds respectively, will be carried in the rear compartment. We wish to carry 48 gallons of fuel. Will we be within the safe envelope?

- (a) Place a dot on the plotter grid at 1300 pounds and 85.00 inches to represent the basic airplane. (See illustration.)
- (b) Slide the slotted plastic into position so that the dot is under the slot for the forward seats, at zero weight.
- (c) Draw a line up the slot to the 380 pound position (180 + 200) and put a dot.
- (d) Continue moving the plastic and plotting points to account for weight in the rear seats (80 + 100), baggage compartment (45), and fuel tanks (288).
- (e) As can be seen from the illustration, the final dot shows the total weight to be 2193 pounds with the C.G. at 89.44. This is well within the envelope.

As fuel is burned off, the weight and C.G. will follow down the fuel line and stay within the envelope for landing.

**SECTION 6
WEIGHT AND BALANCE**

**PIPER AIRCRAFT CORPORATION
PA-28-161, CHEROKEE WARRIOR II**

THIS PAGE INTENTIONALLY LEFT BLANK

6.9 EQUIPMENT LIST

The following is a list of equipment which may be installed in the PA-28-161. It consists of those items used for defining the configuration of an airplane when the basic empty weight is established at the time of licensing. Only those standard items which are alternate standard items and those required to be listed by the certificating authority (FAA) are presented. Items marked with an "X" are those items which were installed on the airplane described below when licensed by the manufacturer.

Where the letter "A," "B," or "C" precedes an item, "A" denotes an item which is required equipment that must be installed in the aircraft; "B" denotes an item which is required equipment that must be installed in the aircraft unless replaced by an optional equivalent item; "C" denotes an optional item which replaces a required item of standard equipment. Where no letter precedes an item, that item is not required equipment.

Unless otherwise indicated, the installation certification basis for the equipment included in this list is the aircraft's approved type design.

PIPER AIRCRAFT CORPORATION

PA-28-161 WARRIOR II

SERIAL NO. _____ REGISTRATION NO. _____ DATE: _____

(a) Propeller and Propeller Accessories

Item No.	Item	Mark if Instl.	Weight (Pounds)	Arm (In.) Aft Datum	Moment (Lb-In.)
1 A	Propeller, Sensenich 74DM6-0-60 Cert. Basis - TC P886		32.4	3.8	123
2	Spinner Dome and Bulkhead Piper Dwg. 35323 or 36850		2.9	3.8	11
4	Spinner Dome and Bulkhead Piper Dwg. 87325		3.3	3.8	13

THIS PAGE INTENTIONALLY LEFT BLANK

(b) Engine and Engine Accessories

Item No.	Item	Mark if Instl.	Weight (Pounds)	Arm (In.) Aft Datum	Moment (Lb-In.)
5 A	Engine				
	a. Lycoming Model 0-320-D2A	_____	272.0	21.3	5794
	b. Lycoming Model 0-320-D3G Cert. Basis - TC 274	_____	268.0	21.3	5708
7 B	Alternator 60 Amp				
	a. Prestolite No. ALY6422 Piper Dwg. 99981-0	_____	10.5	14.0	147
	b. Chrysler 3656624 Piper Dwg. 99945-0	_____	12.4	14.0	174
	c. Chrysler 4111810 Piper Dwg. 99945-3	_____	13.5	14.0	189
9 A	Engine Driven Fuel Pump Lycoming Dwg. 75246 Cert. Basis - TC E274		1.7	36.3	62
10 A	Electric Fuel Pump Bendix P/N 478360		1.8	36.8	66
11 A	Fuel Valve Piper Dwg. 66945 or Allen Aircraft Prod. Inc. No. 6S122	_____	0.4	61.9	25
12 A	Oil Coolers Piper Dwg. 18622 Harrison No. C8526250		1.9	41.3	78
13 A	Air Filter Piper Dwg. 35477		0.9	29.5	27
14 A	Starter Prestolite MZ4218 Cert. Basis - TC E274		*17.0	14.5	247
15 A	Oil Filter LW-13743 (Champion No. CH48110) or Lyc. No. 75528 (AC No. OF5578770) Cert. Basis - TC E274		**2.5	35.3	89

*Included in engine weight.

**Includes adapter.

**SECTION 6
WEIGHT AND BALANCE**

**PIPER AIRCRAFT CORPORATION
PA-28-161, CHEROKEE WARRIOR II**

THIS PAGE INTENTIONALLY LEFT BLANK

(c) Landing Gear and Brakes

Item No.	Item	Mark if Instl.	Weight (Pounds)	Arm (In.) Aft Datum	Moment (Lb-In.)
16 A	Two Main Wheel Assemblies				
	a. Cleveland Aircraft Products Wheel Assy. No. 40-86 Brake Assy. No. 30-55 Cert. Basis - TSO C26a	_____	32.3	109.6	3540
	b. 6.00-6 Type III 4 Ply Rating Tires with Regular Tubes Cert. Basis - TSO C62				
17 A	Nose Wheel Assembly				
	a. Cleveland Aircraft Products Wheel Assy. No. 40-77A Cert. Basis - TSO C26a	_____	2.6	30.8	80
	b. McCauley Industrial Corp. Wheel Assy. No. D-30500 Cert. Basis - TSO C26b	_____	3.6	30.8	111
	c. 5.00-5 Type III 4 Ply Rating Tire with Regular Tube Cert. Basis - TSO C62	_____	5.8	30.8	179
18 A	Hand Brake Master Cylinder Piper Dwg. 65842 (Cleveland Aircraft Products P/N 10-22)	_____	0.6	60.9	37
19 A	Toe Brake Cylinders				
	a. Cleveland Aircraft Products No 10-27	_____	0.7	53.0	37
	b. Gar-Kenyon Instrument No 17000	_____	0.4	53.0	21

**SECTION 6
WEIGHT AND BALANCE**

**PIPER AIRCRAFT CORPORATION
PA-28-161, CHEROKEE WARRIOR II**

THIS PAGE INTENTIONALLY LEFT BLANK

(d) Electrical Equipment

Item No.		Item	Mark if Instl.	Weight (Pounds)	Arm (In.) Aft Datum	Moment (Lb-In.)
20	A	Voltage Regulator Piper Dwg. 68804-3		0.9	51.9	47
21	B	Battery Piper Dwg. 35544 (Rebat S-25)	_____	21.9	114.9	2516
22	A	Starter Relay Piper Dwg. 99130-2 RBM Controls P/N 111-111		1.0	45.8	46
23	A	Overvoltage Relay Piper Dwg. 35544 (Wico X16799)		0.5	55.4	28
24	A	Stall Warning Device Piper Dwg. 35544 (Safe Flight P/N C52207-4)		0.2	80.2	16
25	A	Stall Warning Horn Piper Dwg. 35544 (Safe Flight P/N 35214)	_____	0.2	58.8	12

THIS PAGE INTENTIONALLY LEFT BLANK

(e) Instruments

Item No.	Item	Mark if Instl.	Weight (Pounds)	Arm (In.) Aft Datum	Moment (Lb-In.)
26 B	Altimeter Piper PS50008-2 or -3 Cert. Basis - TSO C10b	_____	1.1	60.9	67
27 B	Airspeed Indicator Piper PS50049-41S Cert. Basis - TSO C2b	_____	0.6	61.8	37
28 A	Compass Piper Dwg. 67462 Cert. Basis - TSO C7c		0.9	59.9	54
29 A	Tachometer Piper Dwg. 62177-3		0.7	61.2	43
30 A	Engine Cluster Piper Dwg. 95241-17		0.8	62.4	50

THIS PAGE INTENTIONALLY LEFT BLANK

(f) Miscellaneous

Item No.	Item	Mark if Instl.	Weight (Pounds)	Arm (In.) Aft Datum	Moment (Lb-In.)
33 A	Front Seat Belts (2) Piper PS50039-4-2A American Safety Eqpt. Corp. 500576 Davis Acft. Prod. Inc. FDC-5900-120-5 (Black) Cert. Basis - TSO C22f		1.8	84.0	151
35 A	Aft Seat Belts (2) Piper PS50039-4-3 American Safety Eqpt. Corp. 449968 Davis Acft. Prod. Inc. FDC-5900-120-2 (Black) Cert. Basis - TSO C22f		1.6	123.0	197
36 B	Left Front Seat Piper Dwg. 79337-21	_____	15.5	84.0	1302
37 B	Right Front Seat Piper Dwg. 79337-2	_____	15.5	84.0	1302
38	Rear Seat Piper Dwg. 35131		27.0	124.1	3351
39 A	a. Shoulder Harness (2) Front Seats Only) Piper PS50039-4-20 Pacific Scientific P/N 110747-13	_____	1.4	119.5	167
B	b. Shoulder Harness-Fixed (Front) (2) Piper Dwg. PS50039-4-23 American Safety Eqpt. Corp. 501385-407 Davis Acft. Prod. Inc. FDC-7275-16-4 (Black)	_____	1.1	119.5	131
40 A	Baggage Straps Piper Dwg. 66804 and 66805		1.3	142.8	186

THIS PAGE INTENTIONALLY LEFT BLANK

(j) Electrical Equipment
(Optional Equipment)

Item No.	Item	Mark if Instl.	Weight (Pounds)	Arm (In.) Aft Datum	Moment (Lb-In.)
79	Instrument Panel Lights Piper Dwg. 35544	_____	0.3	62.8	19
81	Instrument Light (2), Grimes 15-0083-7 or Whelen A300-W-14	_____	0.1	99.0	10
83	Cabin Light Piper Dwg. 95229	_____	0.3	99.0	30
85	Landing Light G.E. Model 4509	_____	0.5	13.1	7
87	Navigation Lights (2) Grimes Model A1285 (Red and Green)	_____	0.4	106.6	43
88	Navigation Light (Rear) (1) Grimes Model A2064 (White)	_____	0.2	281.0	56
89	Navigation Lights (Wing) (2) Red/White & Green/White Whelen Model A675	_____	0.5	106.6	53
90	Navigation Lights (Wing) (2) Red White & Green White with White Strobe (Wing) Whelen Model A600 Fin Strobe (A-470)	_____ _____	5.8 1.1	157.9 216.0	916 238
91	Navigation Lights (Wing) (2) Red White & Green White with Red Strobe (Wing) Fin Strobe (A-470)	_____ _____	5.8 1.1	157.9 216.0	916 238
92	Rotating Beacon Whelen Eng. Co. WRMI-12 Piper Dwg. 63892 or 63518	_____	1.5	263.4	395
93	Anti-Collision Light (Fin only) Piper Dwg. 99033-2 Includes power supply	_____	3.1	210.3	652

**SECTION 6
WEIGHT AND BALANCE**

**PIPER AIRCRAFT CORPORATION
PA-28-161, CHEROKEE WARRIOR II**

(j) Electrical Equipment
(Optional Equipment) (cont)

Item No.	Item	Mark if Instl.	Weight (Pounds)	Arm (In.) Aft Datum	Moment (Lb-In.)
94	Anti-Collision Lights (Wing tips only) Cert. Basis - STC SA800 EA	_____	5.7	157.9	900
95	Anti-Collision Lights (Fin and Wing Tips) Piper Dwg. 99033-10	_____	6.1	172.8	1054
97	Heated Pitot Head Piper Dwg. 35493-2	_____	0.4	100.0	40
99	Piper Pitch Trim. Piper Dwg. 67496-3	_____	4.3	155.3	668
101 C	Battery 12V 35 A.H. Rebat R35 (Wt. 27.2 lbs.)	_____	*5.3	114.9	609
103	Auxiliary Power Receptacle Piper Dwg. 35298	_____	2.7	178.5	482
105	External Power Cable Piper Dwg. 62355-11	_____	4.6	142.8	657
107	Lighter, #200462, 12 Volt Universal	_____	0.2	62.9	13

*Weight and moment difference between standard and optional equipment.

(k) Instruments
(Optional Equipment)

Item No.	Item	Mark if Instl.	Weight (Pounds)	Arm (In.) Aft Datum	Moment (Lb-In.)
113	Vacuum System Installation				
	a. With Airborne Model 211cc Pump	_____	4.5	39.1	176
	b. With Edo-Aire Model 1U128A Pump	_____	4.9	39.1	192
115	Attitude Gyro, Piper Dwg. 99002-2, -3, 4 or -8 Cert. Basis - TSO C4c	_____	2.2	59.4	131
117	Directional Gyro, Piper Dwg. 99003-2, -3, -4 or -7 Cert. Basis - TSO C5c	_____	2.6	59.7	155
119 C	Tru-Speed Indicator Piper PS50049-41 T Cert. Basis - TSO C2b	_____	(same as standard equipment)		
121 C	Encoding Altimeter Piper PS50008-6 or -7 Cert. Basis - TSO C10b, C88	_____	*0.9	60.3	54
122	Altitude Digitizer (United Instruments P/N 5125-P3) Cert. Basis - TSO C88	_____	1.0	51.5	52
123	Vertical Speed Piper Dwg. 99010-2, -4 or -5 Cert. Basis - TSO C8b	_____	1.0	60.9	61
125	Alternate Static Source Piper Dwg. 35493	_____	0.4	61.0	24
127	Turn and Slip Indicator Piper PS50030-2 or -3 Cert. Basis - TSO C3b	_____	2.6	59.7	155

*Weight and moment difference between standard and optional equipment.

**SECTION 6
WEIGHT AND BALANCE**

**PIPER AIRCRAFT CORPORATION
PA-28-161, CHEROKEE WARRIOR II**

(k) Instruments
(Optional Equipment) (cont)

Item No.	Item	Mark if Instl.	Weight (Pounds)	Arm (In.) Aft Datum	Moment (Lb-In.)
129	Engine Hour Meter Piper Dwg. 69889-0	_____	0.3	61.2	18
131	Clock	_____	0.4	62.4	25
132	Control Wheel Digital Clock Piper Dwg. 87347-3	_____	0.3	71.9	22
133	Air Temperature Gauge Piper Dwg. 99479-0 or -2	_____	0.2	72.6	15

(I) Autopilots
(Optional Equipment)

Item No.	Item	Mark if Instl.	Weight (Pounds)	Arm (In.) Aft Datum	Moment (Lb-In.)
141	AutoFlite II Piper Dwg. 99447 Cert. Basis - STC SA3066SW-D	_____	5.6	91.8	514
143	AutoControl IIIB a. Omni Coupler 1C-388 Piper Dwg. 79221 Cert. Basis - STC SA3065SW-D	_____ _____	9.6 1.0	77.6 59.3	745 59
145	AutoPilot - Century 21 Piper Dwg. 39726 Cert. Basis - STC SA3352SW	_____	12.0	69.0	828

**SECTION 6
WEIGHT AND BALANCE**

**PIPER AIRCRAFT CORPORATION
PA-28-161, CHEROKEE WARRIOR II**

**(m) Radio Equipment
(Optional Equipment)**

Item No.	Item	Mark if Instl.	Weight (Pounds)	Arm (In.) Aft Datum	Moment (Lb.-In.)
151	Bendix AS-2015A-7 or -9 Audio Panel	_____	1.0	66.4	66
152	Bendix CN2013-1 Com/Nav Cert. Basis - TSO C34c, C35d, C36c, C37b, C38b, C40a	_____	7.5	61.4	461
153	Bendix CN2013-2 Com/Nav w/G.S. Receiver Cert. Basis - TSO C34c, C35d, C36c, C37b, C38b, C40a	_____	8.2	61.4	504
154	Bendix CN 2013-4 Com/Nav w/G.S. Receiver and M.B. Receiver	_____	8.5	61.4	522
155	Bendix ADF 2070 Cert. Basis - TSO C41c, C2a	_____	6.0*	105.0	630
156	Bendix TR2060 Transponder Cert. Basis - TSO C74c	_____	2.8*	63.6	178
157	Bendix CN2011 Dual Com/Nav Cert. Basis - TSO C34c, C35d C36c, C37b, C40a	_____	16.8	66.8	1122
158	Bendix IN2014B Indicator a. Single b. Dual Cert. Basis - TSO C34c, C 36c, C40a, C66c	_____ _____ _____	1.9 3.8	63.4 63.4	121 241
159	Bendix DME 2030 Cert. Basis - TSO C66a	_____	10.3*	185.0	1906

*Weight includes antenna and cable

(m) Radio Equipment
(Optional Equipment) (cont)

Item No.	Item	Mark if Instl.	Weight (Pounds)	Arm (In.) Aft Datum	Moment (Lb-In.)
161	Collins VHF-250 or VHF-251 Comm Transceiver				
	a. Single	_____	4.0	56.9	228
	b. Dual	_____	8.1	56.9	461
	Cert. Basis - TSO C37b, C38b				
162	Collins VIR-350 or VIR-351 Nav Receiver				
	a. Single	_____	3.9	57.4	224
	b. Dual	_____	7.9	57.4	453
	Cert. Basis - TSO C40a, C36c				
163	Collins IND-350 () VOR/LOC Indicator				
	a. Single	_____	1.0	60.2	60
	b. Dual	_____	2.0	60.2	120
	Cert. Basis - TSO C40a, C36c				
164	Collins IND-351 () VOR/LOC/GS Indicator				
	Cert. Basis - TSO C40a, C36c				
		_____	1.3	60.2	78
165	Collins GLS-350 Glide Slope Receiver				
	Cert. Basis - TSO C34c				
		_____	2.0	183.4	367
167	Collins DCE 400 Distance Computing Equipment				
	Cert. Basis - TSO C40a				
		_____	2.1	58.9	124
168	Collins RCR-650 ADF Receiver and Antenna and IND-650 Indicator				
	Cert. Basis - TSO C41c				
		_____	6.6	104.8	692
169	Collins RCR-650A ADF Receiver and Antenna and IND-650A Indicator				
	Cert. Basis - TSO C41c				
		_____	7.3	100.3	733

**SECTION 6
WEIGHT AND BALANCE**

**PIPER AIRCRAFT CORPORATION
PA-28-161, CHEROKEE WARRIOR II**

(m) Radio Equipment
(Optional Equipment) (cont)

Item No.	Item	Mark if Instl.	Weight (Pounds)	Arm (In.) Aft Datum	Moment (Lb-In.)
170	Collins AMR-350 Audio/Marker Panel Cert. Basis - TSO C35d, C50b	_____	*3.3	110.0	363
171	Collins DME-451 W/Ind. 451 450 Cert. Basis - TSO C66a	_____	8.0	174.9	1399
172	Collins TDR-950 Transponder Cert. Basis - TSO C74c	_____	**2.8	62.9	176
173	King KN 53 Nav/Receiver	_____	2.8	63.8	179
177	King KX 170 () VHF Comm/Nav a. Transceiver, Single b. Transceiver, Dual	_____ _____	7.5 15.0	56.6 56.6	425 849
174	King KN 53 Nav Receiver W GS Receiver a. Single b. Dual	_____ _____	3.1 6.2	63.8 63.8	198 396
175	King KX 155 VHF Nav/Comm Transceiver a. With Audio Amplifier b. With Glide Slope Receiver c. Without Glide Slope Receiver Cert. Basis - TSO C37b, C38b, C40a, C36a	_____ _____ _____	5.0 5.3 4.8	58.1 58.1 58.1	291 308 279
176	King KX 165 VHF Nav/ Comm Transceiver a. With Glide Slope Receiver b. Without Glide Slope Receiver Cert. Basis - TSO C37b, C38b C40a, C36a	_____ _____	5.7 5.1	58.0 58.1	331 296

*Weight includes antenna and cable.

*Weight includes antenna.

(m) Radio Equipment
(Optional Equipment) (cont)

Item No.	Item	Mark if Instl.	Weight (Pounds)	Arm (In.) Aft Datum	Moment (Lb-In.)
178	King KX 175 () VHF				
	a. Transceiver	_____	9.4	56.6	532
	b. King KN 72 VOR/LOC Converter	_____	1.3	183.6	239
	c. King KN 73 Glide Slope Receiver	_____	3.2	184.3	590
	d. KN 75 Glide Slope Receiver	_____	1.6	184.3	295
	e. King KN 77 VOR/LOC Converter	_____	3.6	183.6	661
	f. King KI-204 VOR/ILS Indicator	_____	1.7	60.5	103
	g. King KNI-520 VOR/ILS Indicator	_____	1.7	60.5	103
	Cert. Basis - TSO C36c, C37b, C38b, C40a				
179	King KX 175 () VHF				
	a. Transceiver (2nd)	_____	8.6	56.6	487
	b. King KN 72 VOR/LOC Converter	_____	1.3	183.6	239
	c. King KN 77 VOR/LOC Converter	_____	4.2	183.6	771
	d. King KI-203 VOR/ILS Indicator	_____	1.6	60.5	97
	e. King KNI 520 VOR/ILS Indicator	_____	1.7	60.5	103
	Cert. Basis - TSO C36c, C37b, C38b, C40a				
180	King KY 196E Transceiver with RB 125 Power Booster				
	a. Single	_____	5.7	77.0	439
	b. Dual	_____	11.4	77.0	878
	Cert. Basis - TSO C37b, C38b				
181	King KY 197 Transceiver				
	a. Single	_____	4.2	58.7	246
	b. Dual	_____	8.4	58.7	492
	Cert. Basis - TSO C37B, C38B				
182	King KI 201 () VOR/LOC Ind.				
	a. Single	_____	2.5	59.6	149
	b. Dual	_____	5.0	59.9	300
183	King KI 202 VOR/LOC Indicator				
	Cert. Basis - TSO C40a, C36c				
		_____	1.3	60.9	79

**SECTION 6
WEIGHT AND BALANCE**

**PIPER AIRCRAFT CORPORATION
PA-28-161, CHEROKEE WARRIOR II**

(m) Radio Equipment
(Optional Equipment) (cont)

Item No.	Item	Mark If Instl.	Weight (Pounds)	Arm (In.) Aft Datum	Moment (Lb-In.)
184	King KI 206 VOR/LOC Indicator Cert. Basis - TSO C40a, C36c	_____	1.3	60.9	79
185	King KI 208 VOR LOC Indicator a. Single b. Dual Cert. Basis - TSO C34c, C36c, C40a	_____ _____ _____	1.0 2.0	59.6 59.9	60 120
186	King KI 209 VOR LOC GS Ind. Cert. Basis - TSO C34c C36c, c40a	_____	1.2	59.9	72
187	King KI 213 VOR LOC GS Ind.	_____	2.5	60.4	151
188	King KI 214 () VOR LOC GS Ind.	_____	3.3	59.9	198
189	King KN 74 R-Nav	_____	4.7	56.6	266
191	King KN 61 DME	_____	12.5	179.0	2237
192	King KN 62A DME	_____	3.3	58.3	193
193	King KN 65A DME Cert. Basis - TSO C66a	_____	13.0	174.9	2274
194	King KRA-10 Radio Altimeter	_____	4.3	162.6	699
195	King KR 85 Digital ADF a. Audio Amplifier Cert. Basis - TSO C41b	_____ _____	8.6 0.8	85.2 51.0	733 41
196	King KR 85 ADF with KA 42B Loop and Sense Antenna a. Audio Amplifier Cert. Basis - TSO C41b	_____ _____	9.5 0.8	85.2 51.0	809 41
197	King KR 86 ADF a. First b. Second c. Audio Amplifier	_____ _____ _____	6.7 9.7 0.8	91.6 107.0 51.0	614 1038 41

(m) Radio Equipment
(Optional Equipment) (cont)

Item No.	Item	Mark if Instl.	Weight (Pounds)	Arm (In.) Aft Datum	Moment (Lb-In.)
198	King KR 86 ADF with KA 42B Loop and Sense Antenna				
	a. First	_____	7.6	91.6	696
	b. Second	_____	10.6	107.0	1134
	c. Audio Amplifier	_____	0.8	51.0	41
199	King KR 87 ADF Receiver and Indicator	_____	4.0	59.0	236
	a. KA 44 Antenna	_____	2.8	147.4	413
	b. KA 44B Antenna	_____	3.6	150.6	542
	c. Audio Amplifier	_____	0.8	51.0	41
	Cert. Basis - TSO C41c				
200	King KMA 20 () Audio Panel Cert. Basis - TSO C35c, C50b	_____	*3.7	70.8	262
201	King KMA-24 Audio Panel Cert. Basis - TSO C35d, C50b	_____	1.7	65.3	111
203	King KT 76 ()/78 () Transponder Cert. Basis - TSO C74b	_____	*3.1	58.1	180
204	Narco Comm 10A VHF Transceiver	_____	3.9	57.4	224
205	Narco Comm 11A VHF Transceiver				
	a. Single	_____	3.6	57.4	207
	b. Dual	_____	7.1	57.4	408
207	Narco Comm 11B VHF Transceiver				
	a. Single	_____	3.9	57.4	224
	b. Dual	_____	7.8	57.4	448

*Weight includes antenna and cable.

**SECTION 6
WEIGHT AND BALANCE**

**PIPER AIRCRAFT CORPORATION
PA-28-161, CHEROKEE WARRIOR II**

(m) Radio Equipment
(Optional Equipment) (cont)

Item No.	Item	Mark if Instl.	Weight (Pounds)	Arm (In.) Aft Datum	Moment (Lb-In.)
209	Narco Comm 111 VHF Transceiver				
	a. Single	_____	3.0	57.4	172
	b. Dual	_____	6.0	57.4	344
	Cert. Basis - TSO C37b, C38b				
211	Narco Comm IIIB VHF Transceiver				
	a. Single	_____	3.9	57.4	224
	b. Dual	_____	7.8	57.4	448
	Cert. Basis - TSO C37b, C38b				
213	Narco Comm 120 VHF Transceiver				
	a. Single	_____	4.8	56.9	273
	b. Dual	_____	8.6	57.4	494
	Cert. Basis - TSO C37b, C38b				
215	Narco Nav 10 VHF Receiver	_____	1.9	58.6	111
217	Narco Nav 11 VHF Receiver				
	a. Single	_____	2.8	58.6	164
	b. Dual	_____	5.6	58.6	328
219	Narco Nav 12 VHF Receiver	_____	3.4	58.6	199
221	Narco Nav 14 VHF Receiver	_____	2.5	57.4	144
223	Narco Nav 111 Cert. Basis - TSO C36c, C40a, C66a	_____	2.5	58.6	147
225	Narco Nav 112 Receiver Cert. Basis - TSO C36c, C40a, C66c, C34c	_____	3.3	58.6	193
227	Narco Nav 114 VHF Receiver Cert. Basis - TSO C38b, C40a, C36c, C34c, C66a	_____	2.5	57.4	144

*Weight includes marker antenna and cable.

(m) Radio Equipment
(Optional Equipment) (cont)

Item No.	Item	Mark if Instl.	Weight (Pounds)	Arm (In.) Aft Datum	Moment (Lb-In.)
229	Narco Nav 121 VHF Receiver				
	a. Single	_____	3.1	58.4	181
	b. Dual	_____	6.2	58.4	362
	Cert. Basis - TSO C36c, C40c, C66a				
231	Narco Nav 122 VHF Receiver				
	a. Single	_____	*5.1	99.4	507
	b. Dual	_____	*8.6	82.9	713
	Cert. Basis - TSO C35d, C36c, C40c, C66a				
233	Narco Nav 122A VHF Receiver				
	a. Single	_____	* 5.2	98.5	512
	b. Dual	_____	* 8.8	82.2	723
	Cert. Basis - TSO C34c, C35d, C36c, C40c, C66a				
235	Narco Nav 124A VHF Receiver				
	a. Single	_____	* 6.2	92.3	572
	b. Dual	_____	*10.9	77.2	841
	Cert. Basis - TSO C35d, C36c, C40a, C66a				
237	Narco ID 124 VOR/LOC/GS Indicator				
	a. Single	_____	1.2	60.5	73
	b. Dual	_____	2.4	60.5	145
	Cert. Basis - TSO C34c, C35d, C36c, C40c				
239	Narco UGR-2A Glide Slope				
	a. Single	_____	4.2	154.0	647
	b. Dual	_____	8.4	220.0	1848
	Cert. Basis - TSO C34b				
241	Narco UGR-3 Glide Slope	_____	4.2	154.0	647
243	Narco MBT-12-R, Marker Beacon	_____	3.1	69.1	214
245	Narco CP-125 Audio Selector Panel	_____	2.2	60.2	132

*Weight includes marker antenna and cable.

**SECTION 6
WEIGHT AND BALANCE**

**PIPER AIRCRAFT CORPORATION
PA-28-161, CHEROKEE WARRIOR II**

(m) Radio Equipment
(Optional Equipment) (cont)

Item No.	Item	Mark if Instl.	Weight (Pounds)	Arm (In.) Aft Datum	Moment (Lb-In.)
247	Narco CPI 35 Audio Selector Panel Cert. Basis - TSO C50b	_____	.22	55.0	121
249	Narco CPI 35M Audio Selector Panel Cert. Basis - TSO C50b, C35d	_____	* 3.7	114.3	423
251	Narco DME-190	_____	** 5.9	61.0	360
253	Narco DME-190 TSO Cert. Basis - TSO C66a	_____	** 5.9	60.9	359
255	Narco DME-195 Receiver and Indicator Cert. Basis - TSO C66a	_____	**13.2	154.5	2039
257	Narco ADF-140 a. Single b. Dual Cert. Basis - TSO C41c	_____ _____ _____	6.0 ***17.9	91.2 107.6	547 1926
259	Narco ADF-141 a. Single b. Dual Cert. Basis - TSO C41c	_____ _____ _____	6.0 ***17.9	91.2 107.6	547 1926
261	Narco AT50A Transponder Cert. Basis - TSO C74b a. Narco AR-500 Altitude Encoder Cert. Basis - TSO C88	_____ _____ _____	** 3.0 1.0	57.3 51.5	172 52
263	Narco AT150 Transponder Cert. Basis - TSO C74c a. Narco AR-500 Altitude Encoder Cert. Basis - TSO C88	_____ _____ _____	** 3.0 1.0	57.3 51.5	172 52

*Weight includes marker antenna and cable.

**Weight includes antenna and cable.

***Weight includes dual antenna and cable.

(m) Radio Equipment
(Optional Equipment) (cont)

Item No.	Item	Mark if Instl.	Weight (Pounds)	Arm (In.) Aft Datum	Moment (Lb-In.)
273	Antenna and Cable				
	a. Nav Receiving VRP-37 or AV12-PPR	_____	1.6	171.3	274
	b. #1 VHF Comm VTP-17	_____	0.7	125.7	88
	c. #2 VHF Comm VTP-17	_____	0.8	147.5	118
	d. Glide Slope (Single) GS401 or CI 104	_____	0.9	120.0	108
	e. Glide Slope (Dual) GS401 or CI 104	_____	2.8	151.0	431
	f. Single ADF Sense 99841 Piper Dwg. 99461	_____	0.4	150.0	60
275	Anti Static Antenna and Cable				
	a. #1 VHF Comm PS50040-18	_____	1.4	144.3	202
	b. #2 VHF Comm PS50040-18	_____	1.5	170.7	256
	c. Single ADF Sense 79160	_____	0.5	147.5	74
276	Marker Beacon Antenna Piper PS50040-15 King KA-23 or Narco VMA-15 or Comant CI-102				
				Included as part of marker beacon installation	
277	Marker Beacon Antenna Comant CI 102 Piper Dwg. 39737-4	_____	*1.2	175.0	210
278	Emergency Locator Transmitter (C.C.C. Model CIR-11-2)				
	a. Antenna and Coax	_____	1.7	236.2	402
	b. Shelf and Access Hole	_____	0.2	224.4	45
	Cert. Basis - TSO C91	_____	0.5	235.4	118
279	Emergency Locator Transmitter (Narco Model ELT-10)				
	a. Antenna and Coax	_____	3.5	236.2	827
	b. Shelf and Access Hole	_____	0.3	224.4	67
	Cert. Basis - TSO C91	_____	0.5	235.4	118
280	Microphone				
	a. Piper Dwg. 68856-10	_____	0.3	69.9	21
	b. Piper Dwg. 68856-11	_____	0.6	69.9	42
	c. Piper Dwg. 68856-12	_____	0.3	69.9	21

*Weight includes antenna coax wire to Marker Beacon Receiver.

**SECTION 6
WEIGHT AND BALANCE**

**PIPER AIRCRAFT CORPORATION
PA-28-161, CHEROKEE WARRIOR II**

(m) Radio Equipment
(Optional Equipment) (cont)

Item No.	Item	Mark if Instl.	Weight (Pounds)	Arm (In.) Aft Datum	Moment (Lb-In.)
281	Boom Microphone, Headset Piper Dwg. 37921-2	_____	0.3	80.5	24
283	Cabin Speaker Piper Dwg. 99220	_____	1.1	99.0	109
285	Headset Piper Dwg. 68856-10	_____	0.5	60.0	30

THIS PAGE INTENTIONALLY LEFT BLANK

**SECTION 6
WEIGHT AND BALANCE**

**PIPER AIRCRAFT CORPORATION
PA-28-161, CHEROKEE WARRIOR II**

THIS PAGE INTENTIONALLY LEFT BLANK

(n) Miscellaneous
(Optional Equipment)

Item No.	Item	Mark if Instl.	Weight (Pounds)	Arm (In.) Aft Datum	Moment (Lb.-In.)
321	Zinc Chromate Finish Piper Dwg. 79700	_____	5.0	158.0	790
323	Stainless Steel Control Cables Piper Dwg. 79700	_____	-	-	-
325	Air Conditioner Piper Dwg. 99575-4	_____	68.3	103.6	7076
327	Overhead Vent System a. Piper Dwg. 76304-9 b. Piper Dwg. 76304-15	_____ _____	6.4 5.7	159.6 148.9	1022 849
329	Overhead Vent System with Ground Ventilating Blower a. Piper Dwg. 76304-10 b. Piper Dwg. 76304-16	_____ _____	14.9 14.2	172.2 168.5	2566 2393
331	Rear Seat Vents Piper Dwg. 68556	_____	2.5	98.0	245
333	Assist Step Piper Dwg. 65384	_____	1.8	156.0	281
335	Super Cabin Sound Proofing Piper Dwg. 79030-2	_____	18.1	86.8	1571
337 C	Adjustable Front Seat (Left) Piper Dwg. 79591-0/79591-2	_____	*6.6	80.3	530
339	Adjustable Front Seat (Right) Piper Dwg. 79591-1/79591-3	_____	*6.6	79.6	525
341	Headrests (2) Front Piper Dwg. 79337-18	_____	2.2	94.5	208
342	Shoulder Harness Inertia (Front) (2) Piper Dwg. PS50039-4-20 Pacific Scientific 1107447-13 (Black)	_____	1.3	119.5	155

*Weight and moment difference between standard and optional equipment.

**SECTION 6
WEIGHT AND BALANCE**

**PIPER AIRCRAFT CORPORATION
PA-28-161, CHEROKEE WARRIOR II**

(n) Miscellaneous
(Optional Equipment) (cont)

Item No.	Item	Mark if Instl.	Weight (Pounds)	Arm (In.) Aft Datum	Moment (Lb-In.)
343	Inertia Safety Belts (Rear) (2) 0.8 lbs. each, Piper PS50039-4-14 Pacific Scientific 1107319-01 American Safety Eqpt. Corp. 500853-401 (Black)	_____	1.6	140.3	224
344	Shoulder Harness - Fixed (Rear) (2) Piper Dwg. PS50039-4-22 American Safety Eqpt. Corp. 501385-403 Davis Acft. Prod. Inc. FDC-7275-16-2 (Black)	_____	1.1	140.3	154
345	Shoulder Harness - Inertia (Rear) (2) Piper Dwg. PS50039-4-19 Pacific Scientific 1107447-01 (Black)	_____	1.3	140.3	187
346	Sun Visors Piper Dwg. 66991-0	_____	1.5	85.0	128
347	Assist Strap Piper Dwg. 79455	_____	0.2	109.5	22
349	Curtain and Rod Installation Piper Dwg. 67955-2	_____	4.2	124.0	521
351	Luxurious Interior Piper Dwg. 67952-4	_____	*14.5	98.3	1425
352	Deluxe Carpeting Piper Dwg. 66801	_____	*2.6	97.8	254
355	Fire Extinguisher a. Piper Dwg. 76167-2, Scott 42211-00	_____	4.6	71.0	327
	b. Piper Dwg. 37872-2, Graviner HA 1014-01	_____	5.6	57.9	324
357	Tow Bar Piper Dwg. 99458	_____	1.3	156.0	203

*Weight and moment difference between standard and optional equipment.

(n) Miscellaneous
(Optional Equipment) (cont)

Item No.	Item	Mark if Instl.	Weight (Pounds)	Arm (In.) Aft Datum	Moment (Lb-In.)
361	Locking Gas Cap Piper Dwg. 39830-2	_____	*0.1	94.1	9

*Weight and moment difference between standard and optional equipment.

TOTAL OPTIONAL EQUIPMENT _____

**SECTION 6
WEIGHT AND BALANCE**

**PIPER AIRCRAFT CORPORATION
PA-28-161, CHEROKEE WARRIOR II**

THIS PAGE INTENTIONALLY LEFT BLANK

TABLE OF CONTENTS

SECTION 7

DESCRIPTION AND OPERATION OF THE AIRPLANE AND ITS SYSTEMS

Paragraph No.		Page No.
7.1	The Airplane	7-1
7.3	Airframe	7-1
7.5	Engine and Propeller	7-3
7.7	Landing Gear.....	7-5
7.9	Flight Controls	7-7
7.11	Engine Controls.....	7-8
7.13	Fuel System.....	7-10
7.15	Electrical System.....	7-12
7.17	Vacuum System.....	7-15
7.19	Instrument Panel	7-16
7.21	Pitot-Static System.....	7-18
7.23	Heating and Ventilating System.....	7-21
7.25	Cabin Features.....	7-21
7.27	Baggage Area.....	7-22
7.29	Stall Warning.....	7-22
7.31	Finish.....	7-22
7.33	Piper External Power	7-23
7.35	Emergency Locator Transmitter.....	7-23
7.37	Air Conditioning	7-25
7.39	Carburetor Ice Detection System	7-26

BLANK PAGE

SECTION 7

**DESCRIPTION AND OPERATION
OF THE AIRPLANE AND ITS SYSTEMS**

7.1 THE AIRPLANE

The Cherokee Warrior II is a single-engine, fixed gear monoplane of all metal construction with low semi-tapered wings. It has four place seating and a two hundred pound baggage capacity.

7.3 AIRFRAME

The primary structure, with the exception of the steel tube engine mount, steel landing gear struts and isolated areas, is of aluminum alloy construction. Fiberglass and thermoplastic are used extensively in the extremities - the wing tips, the engine cowling, etc. - and in nonstructural components throughout the airplane.

The fuselage is a conventional semi-monocoque structure. On the right side of the airplane is a cabin door for entrance and exit and a baggage door to provide loading into the 24 cubic foot compartment.

The wing is a conventional semi-tapered design incorporating a laminar flow, NACA 65:415, airfoil section. The cantilever wings are attached to each side of the fuselage by insertion of the butt ends of the main spars into a spar box carry-through which is an integral part of the fuselage structure. The spar box carry-through structure, located under the rear seat, provides in effect a continuous main spar with splices at each side of the fuselage. There are also fore and aft attachments at the rear and at an auxiliary front spar.

THIS PAGE INTENTIONALLY LEFT BLANK

7.5 ENGINE AND PROPELLER

The PA-28-161 is powered by a four cylinder, direct drive, horizontally opposed engine rated at 160 H P at 2700 RPM. It is equipped with a starter, a 60 amp 14 volt alternator, a shielded ignition, two magnetos, vacuum pump drive, a fuel pump, a wetted polyurethane foam induction air filter.

The engine compartment is accessible for inspection through top-hinged side panels on either side of the engine cowlings. The engine cowlings are cantilever structures attached at the fire wall. The engine mounts are constructed of steel tubing, and dynafocal mounts are provided to reduce vibration.

The exhaust system is constructed of stainless steel and incorporates dual mufflers with heater shrouds to supply heated air for the cabin, the defroster system and the carburetor deicing system.

An oil cooler is located on the left rear of the engine mounted to the engine baffling. Engine cooling air, which is picked up in the nose section of the engine cowling and carried through the baffling, is utilized on the left side for the oil cooler. A winterization plate is provided to restrict air during winter operation (refer to paragraph 8.29).

Engine air enters on either side of the propeller through openings in a nose cowling and is carried through the engine baffling around the engine and oil cooler. Air for the muffler shroud is also picked up from the nose cowling and carried through a duct to the shroud. Carburetor induction air enters a chin scoop on the lower right cowling and is passed through a wetted polyurethane filter to the carburetor air box. Heated air enters the carburetor air box through a hose connected to the heater shroud.

A fixed pitch propeller is installed as standard equipment. The propeller has a 74 inch diameter with a 58 or 60 inch pitch. The pitch is determined at 75% of the diameter. The propeller is made of an aluminum alloy construction.

The pilot should read and follow the procedures recommended in the Lycoming Operator's Manual for this engine in order to obtain maximum engine efficiency and time between engine overhauls.

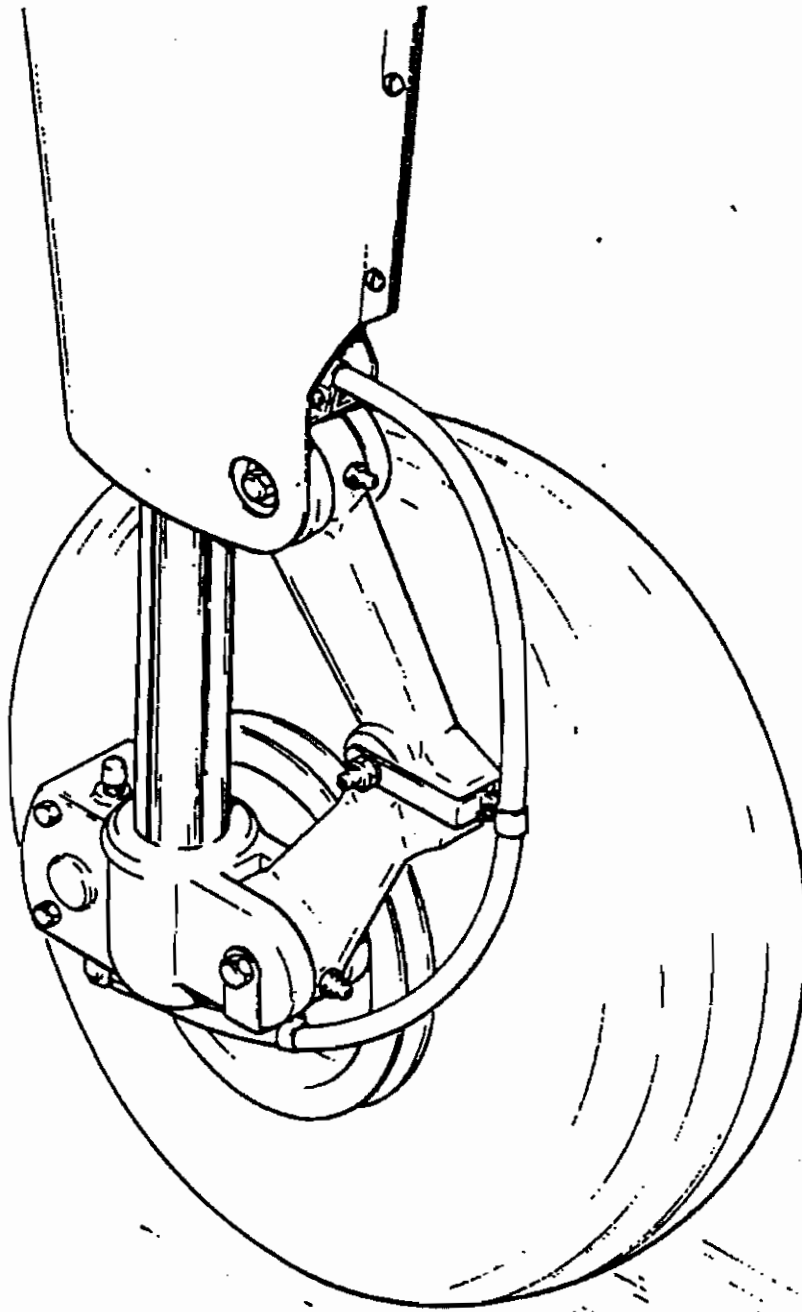

MAIN WHEEL ASSEMBLY

Figure 7-1

7.7 LANDING GEAR

The fixed gear PA-28-161 is equipped with a Cleveland 5.00 x 5 wheel on the nose gear and a Cleveland 6.00 x 6 wheel on each main gear (Figure 7-1). Cleveland single disc hydraulic brake assemblies are provided on the main gear. The nose gear has a 5.00 x 5 four ply tire, while the main wheel assemblies have 6.00 x 6 four ply tires. At gross weight, the main gear tires require a pressure of 24 psi, and the nose gear tire requires a pressure of 30 psi.

The nose gear is steerable through a 30 degree arc each side of center by the use of the rudder pedals and toe brakes. A spring device is incorporated for rudder centering and to provide rudder trim. A bungee assembly on the nose gear steering mechanism reduces ground steering effort and dampens shocks and bumps during taxiing. The steering mechanism also incorporates a shimmy dampener.

The three struts are of the air-oil type with the normal static load extension being 3.25 inches for the nose gear and 4.50 inches for the main gear.

The brakes are actuated by toe brake pedals which are attached to the rudder pedals or by a hand lever and master cylinder located below and behind the center of the instrument sub panel. Hydraulic cylinders are located above each pedal and adjacent to the hand brake lever. The brake fluid reservoir is installed on the top left front face of the fire wall. The parking brake is incorporated in the master cylinder and is actuated by pulling back on the brake lever and depressing the knob attached to the left side of the handle. To release the parking brake, pull back on the brake lever to disengage the catch mechanism and allow the handle to swing forward (refer to Figure 7-5).

THIS PAGE INTENTIONALLY LEFT BLANK

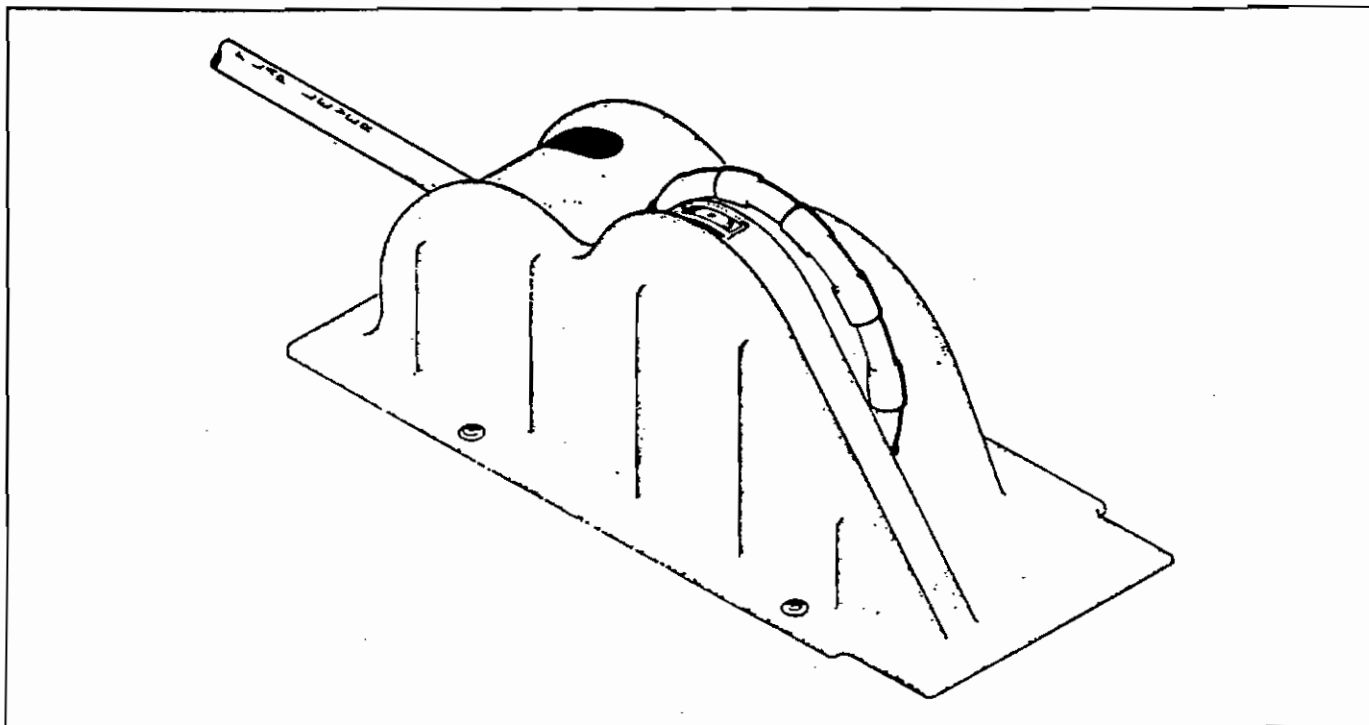

FLIGHT CONTROL CONSOLE

Figure 7-3

7.9 FLIGHT CONTROLS

Dual flight controls are provided as standard equipment. The flight controls actuate the control surfaces through a cable system.

The horizontal surface (stabilator) is of the flying tail design with a trim tab mounted on the trailing edge. This tab serves the dual function of providing trim control and pitch control forces. The trim tab is actuated by a trim control wheel located on the control console between the front seats (Figure 7-3). Forward rotation of the wheel gives nose down trim and aft rotation gives nose up trim.

The rudder is conventional in design and incorporates a rudder trim. The trim mechanism is a spring loaded recentering device. The trim control is located on the right side of the pedestal below the throttle quadrant (refer to Figure 7-5). Turning the trim control clockwise gives nose right trim and counterclockwise rotation gives nose left trim.

Manually controlled flaps are provided on the PA-28-161. The flaps are balanced and spring loaded to return to the retracted (up) position. A control handle, which is located between the two front seats on the control console (Figure 7-3), extends the flaps by the use of a control cable. To extend the flaps, the handle is pulled up to the desired flap setting of 10, 25 or 40 degrees. To retract, depress the button on the end of the handle and lower the control. When extending or retracting flaps, there is a pitch change in the airplane. This pitch change can be corrected either by stabilator trim or increased control wheel force. When the flaps are in the retracted (up) position the right flap, provided with an over-center lock mechanism, acts as a step.

NOTE

The right flap will support a load only in the fully retracted (up) position. When the flap is to be used as a step, make sure the flaps are in the retracted (up) position.

7.11 ENGINE CONTROLS

Engine controls consist of a throttle control and a mixture control lever. These controls are located on the control quadrant on the lower center of the instrument panel (Figure 7-5) where they are accessible to both the pilot and the copilot. The controls utilize teflon-lined control cables to reduce friction and binding.

The throttle lever is used to adjust engine RPM. The mixture control lever is used to adjust the air to fuel ratio. The engine is shut down by the placing of the mixture lever in the full lean position. For information on the leaning procedure, see the Avco-Lycoming Operator's Manual.

The friction adjustment lever on the right side of the control quadrant may be adjusted to increase or decrease the friction holding the throttle and mixture controls or to lock the controls in a selected position.

The carburetor heat control lever is located to the right of the control quadrant on the instrument panel. The control is placarded with two positions: "ON" (down), "OFF" (up).

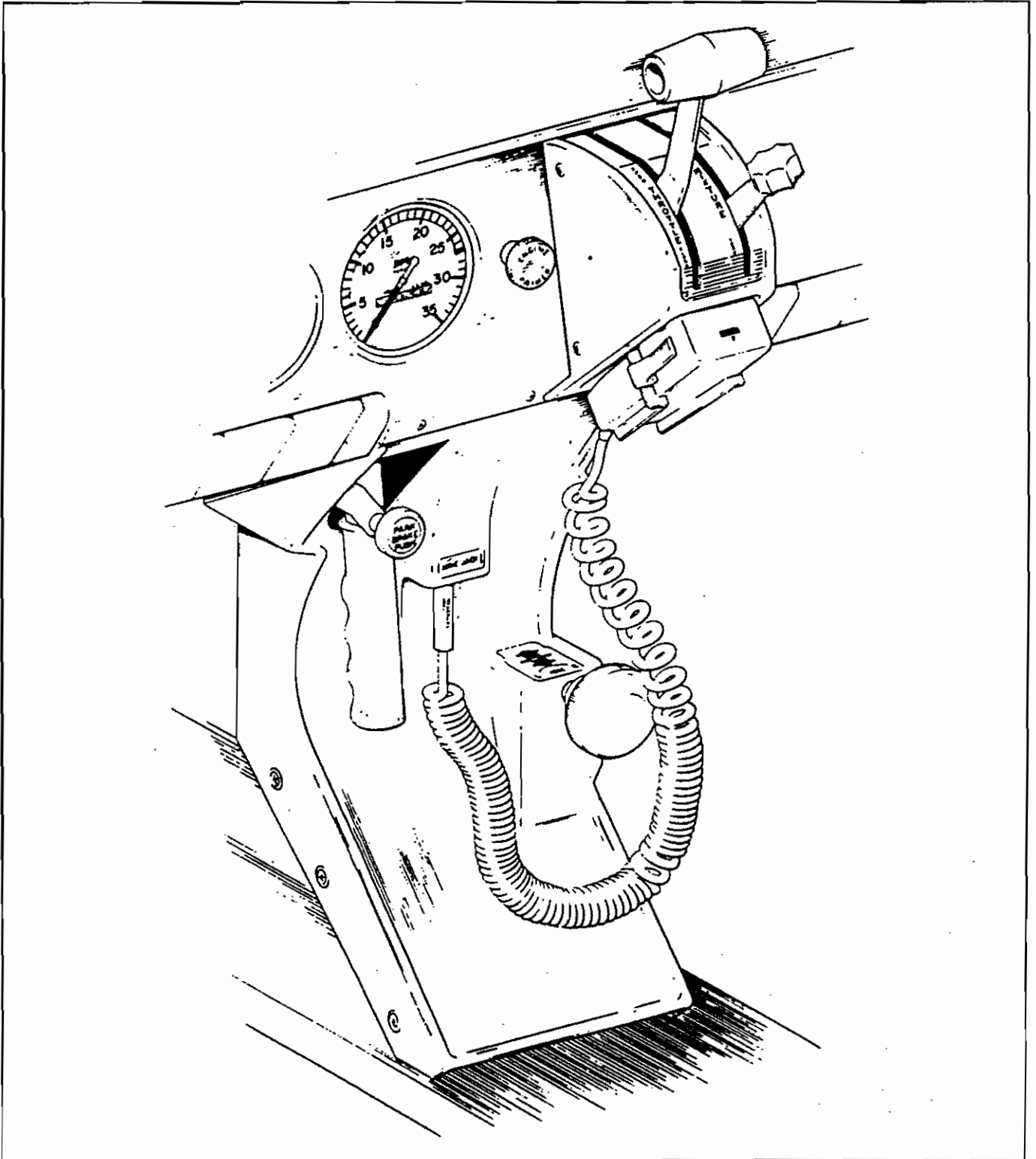

CONTROL QUADRANT AND CONSOLE

Figure 7-5

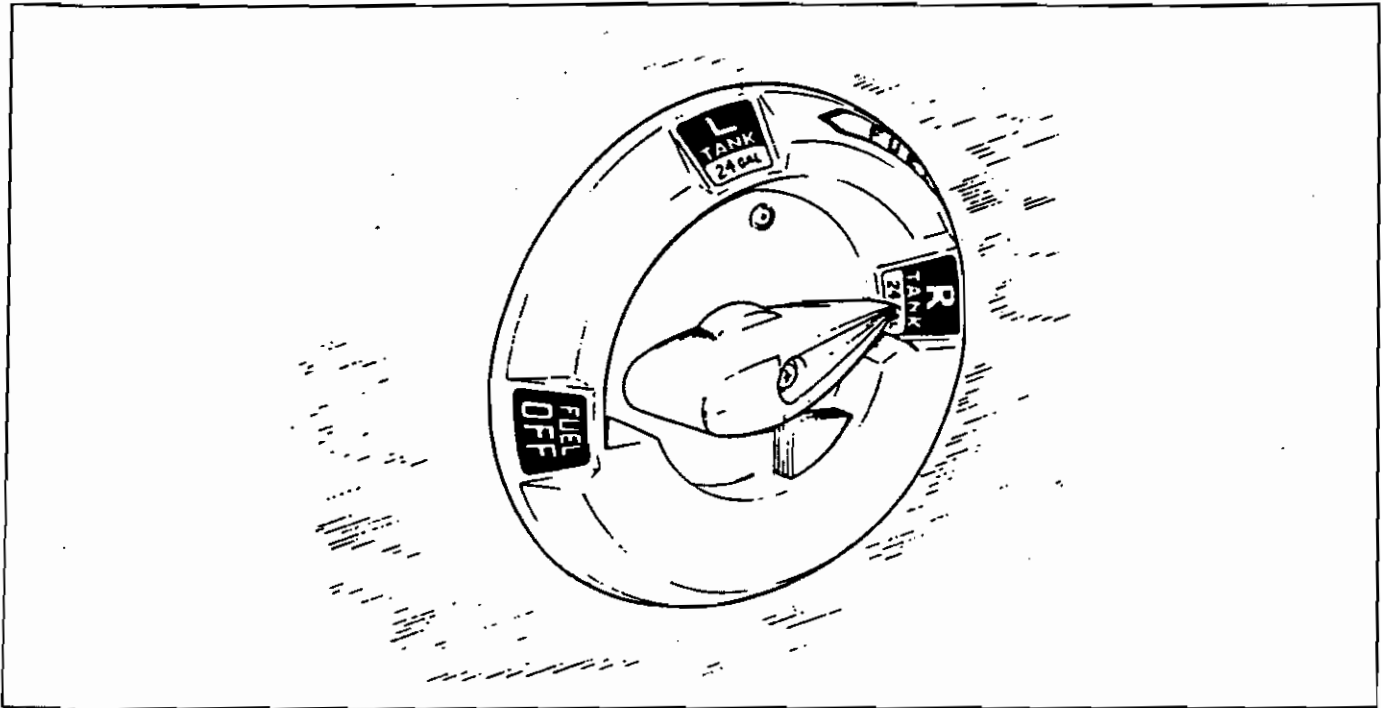

FUEL SELECTOR

Figure 7-7

7.13 FUEL SYSTEM

Fuel is stored in two twenty-five gallon (24 gallons usable) fuel tanks, giving the airplane a total capacity of fifty U.S. gallons (48 gallons usable). Each tank is equipped with a filler neck indicator tab to aid in determining fuel remaining when the tanks are not full. Usable capacity to the bottom of the indicator tab is 17 gallons. The tanks are secured to the leading edge of each wing with screws and nut plates. This allows removal for service or inspection.

The fuel tank selector control (Figure 7-7) is located on the left side panel forward of the pilot's seat. The button on the selector cover must be depressed and held while the handle is moved to the OFF position. The button releases automatically when the handle is moved back to the ON position.

An auxiliary electric fuel pump is provided in case of the failure of the engine driven pump. The electric pump should be ON for all takeoffs and landings and when switching tanks. The fuel pump switch is located in the switch panel above the throttle quadrant.

The fuel drains should be opened daily prior to first flight to check for water or sediment. Each tank has an individual drain at the bottom, inboard rear corner.

A fuel strainer, located on the lower left front of the fire wall, has a drain which is accessible from outside the nose section. The strainer should also be drained before the first flight of the day. Refer to paragraph 8.21 for the complete fuel draining procedure.

Optional locking fuel caps are available for all fillers. A single key will fit fuel caps, cabin door and baggage door compartments.

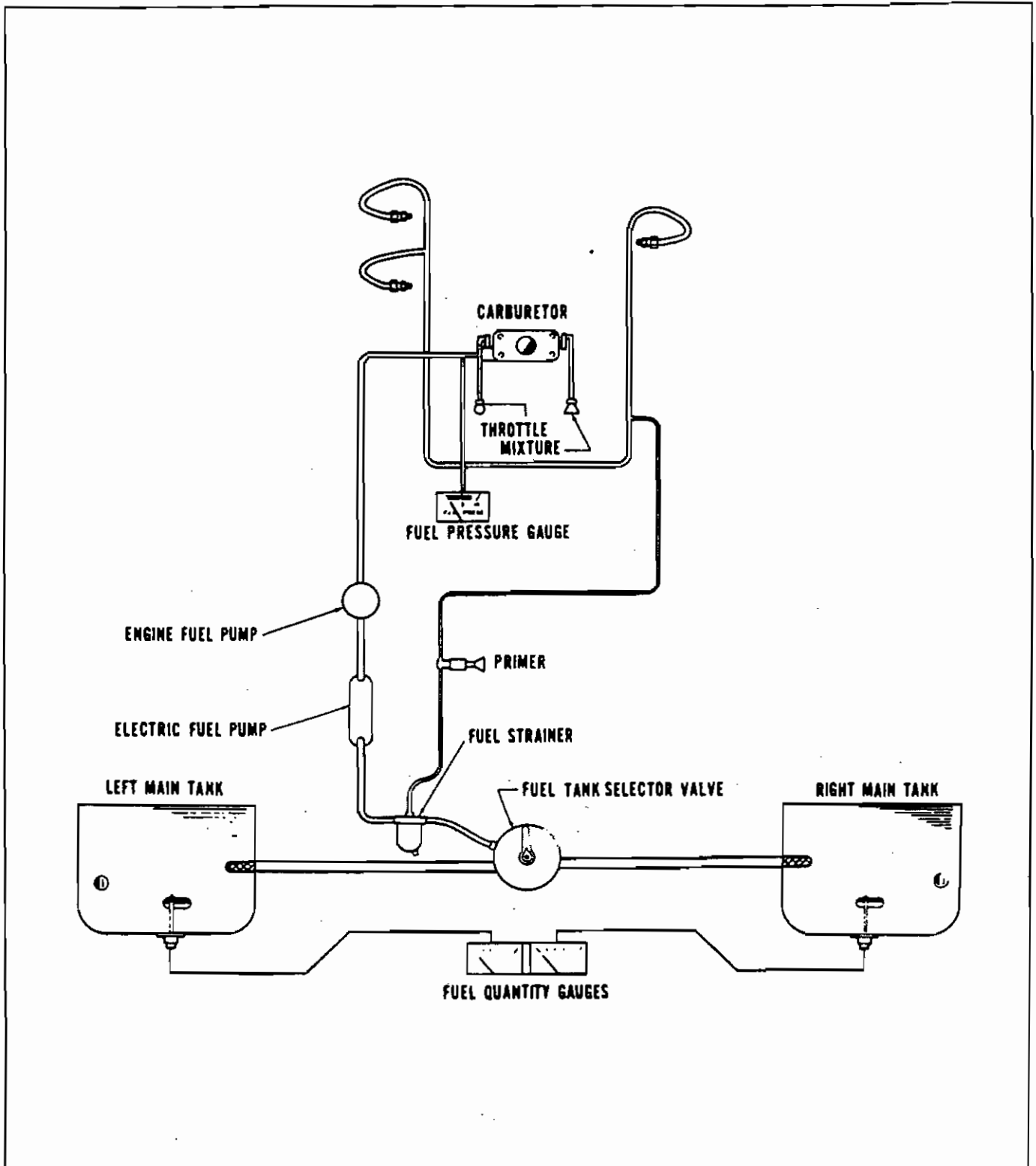

FUEL SYSTEM SCHEMATIC

Figure 7-9

Fuel quantity and fuel pressure gauges are mounted in a gauge cluster located on the left side of the instrument panel to the right of the control wheel (refer to Figure 7-15).

An optional engine priming system is available to facilitate starting. The primer pump is located to the immediate left of the throttle quadrant (refer to Figure 7-5).

7.15 ELECTRICAL SYSTEM

The electrical system includes a 14-volt, 60 amp alternator, a 12-volt battery, a voltage regulator, an over-voltage relay and a master switch relay (Figure 7-11). The battery is mounted in a thermoplastic box immediately aft of the main spar on the right side of the fuselage below the rear passenger seat. The regulator and overvoltage relay are located on the forward left side of the fuselage behind the instrument panel.

Electrical switches are located on the right center instrument panel (refer to Figure 7-15) and the circuit breakers are located on the lower right instrument panel (refer to Figure 7-13). A rheostat switch on the left side of the switch panel controls the navigational lights and the radio lights. The similar switch on the right side controls and dims the panel lights.

Standard electrical accessories include a starter, electric fuel pump, stall warning indicator, cigar lighter, fuel gauge, ammeter, and annunciator panel.

The annunciator panel includes alternator and low oil pressure indicator lights. When the optional gyro system is installed, the annunciator panel also includes a low vacuum indicator light. The annunciator panel lights are provided only as a warning to the pilot that a system may not be operating properly, and that he should check and monitor the applicable system gauge to determine when or if any necessary action is required.

Optional electrical accessories include navigation lights, anti-collision light, landing light, instrument lighting, and cabin dome light. Circuits will handle the addition of communications and navigational equipment.

An optional light, mounted in the overhead panel, provides instrument and cockpit lighting for night flying. The light is controlled by a rheostat switch located adjacent to the light. A map light window in the lens is actuated by an adjacent switch.

WARNING

Anti-collision lights should not be operating when flying through cloud, fog or haze, since the reflected light can produce spatial disorientation. Strobe lights should not be used in close proximity to the ground such as during taxiing, takeoff or landing.

NOTE

On airplanes with interlocked BAT and ALT switches, the ALT switch is mechanically interlocked with the BAT switch. When ALT switch is turned ON, the BAT switch will also be turned ON. On airplanes with separate BAT and ALT switch operation, the switches may be positioned independently as desired.

Unlike previous generator systems, the ammeter as installed does not show battery discharge; rather, it indicates the electrical load on the alternator in amperes. With all the electrical equipment off and the master switch on, the ammeter will indicate the charging rate of the battery. As each electrical unit is switched on, the ammeter will indicate the total ampere draw of all the units including the battery. For example, the average continuous load for night flight with radios on is about 30 amperes. This 30 ampere value plus approximately 2 amperes for a fully charged battery will appear continuously under these flight conditions. The amount of current shown on the ammeter will tell immediately if the alternator system is operating normally, as the amount of current shown should equal the total amperage drawn by the electrical equipment which is operating.

For abnormal and/or emergency operation and procedures, see Section 3.

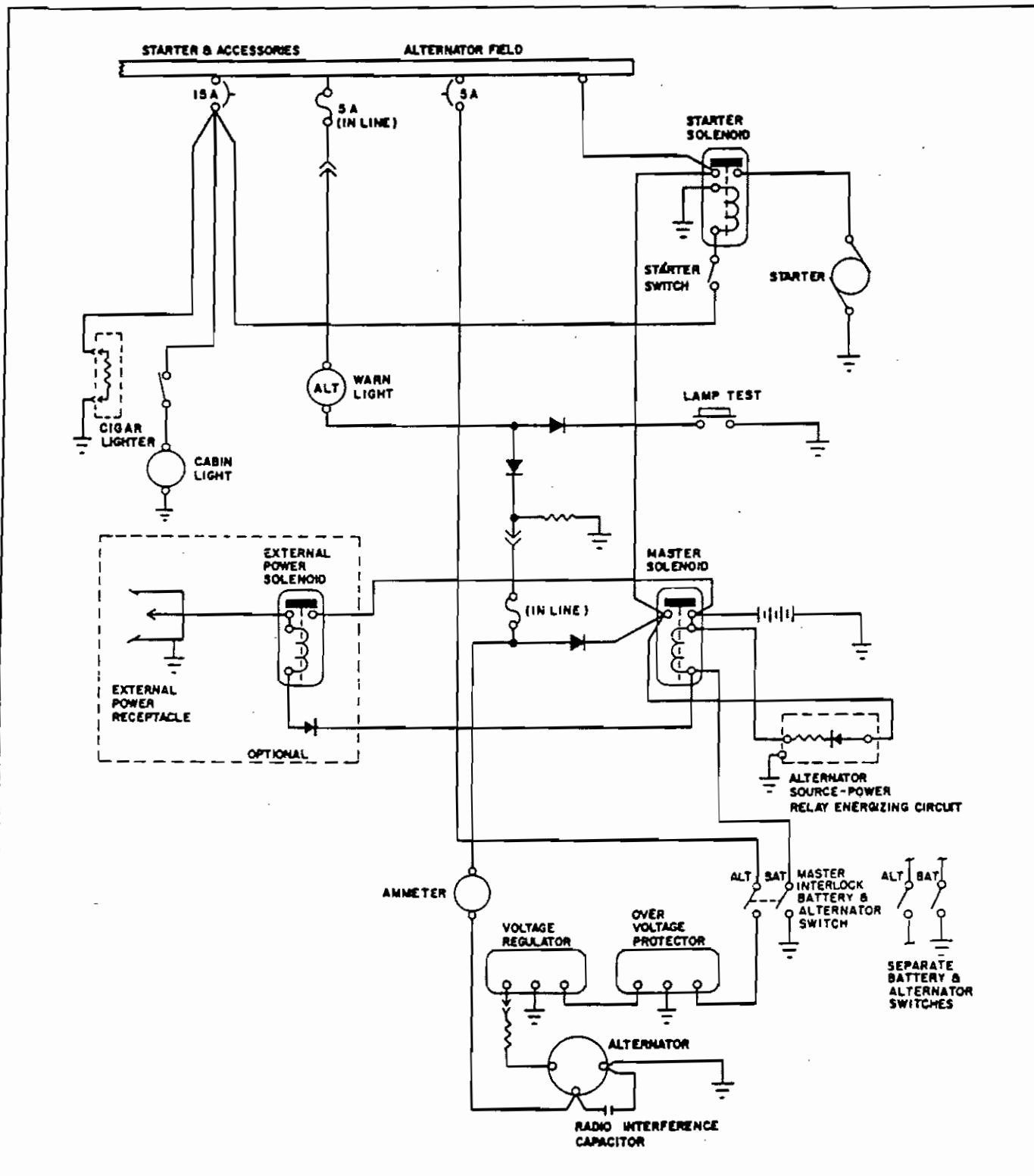

ALTERNATOR AND STARTER SCHEMATIC

Figure 7-11

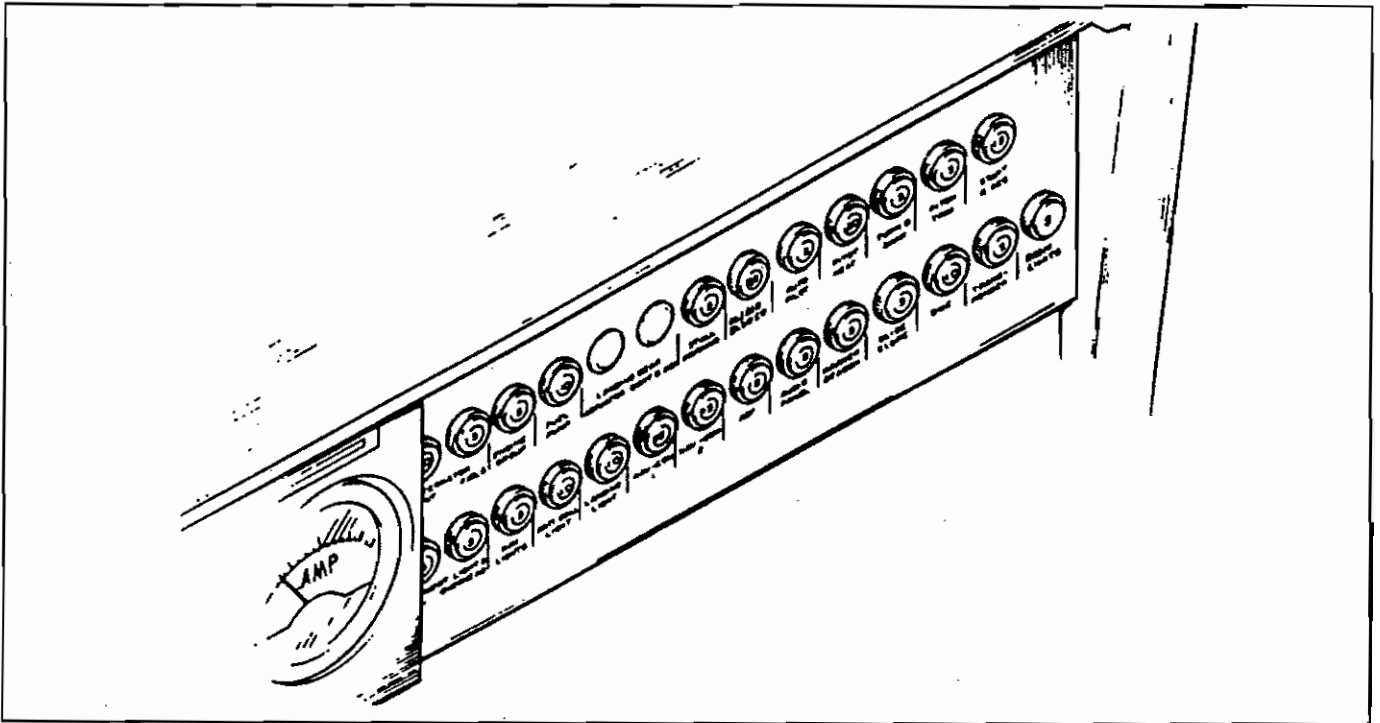

CIRCUIT BREAKER PANEL

Figure 7-13

7.17 VACUUM SYSTEM*

The vacuum system is designed to operate the air driven gyro instruments. This includes the directional and attitude gyros when installed. The system consists of an engine driven vacuum pump, a vacuum regulator, a filter and the necessary plumbing.

The vacuum pump is a dry type pump. A shear drive protects the pump from damage. If the drive shears, the gyros will become inoperative.

A vacuum gauge, mounted on the far right instrument panel provides a pilot check for the system during operation. A decrease in pressure in a system that remained constant over an extended period may indicate a dirty filter, dirty screens, possibly a sticky vacuum regulator or leak in the system (a low vacuum indicator light is provided in the annunciator panel). Zero pressure would indicate a sheared pump drive, defective pump, possibly a defective gauge or collapsed line. In the event of any gauge variation from the norm, the pilot should have a mechanic check the system to prevent possible damage to the system components or eventual failure of the system.

A vacuum regulator is provided in the system to protect the gyros. The valve is set so the normal vacuum reads $5.0 \pm .1$ inches of mercury, a setting which provides sufficient vacuum to operate all the gyros at their rated RPM. Higher settings will damage the gyros and with a low setting the gyros will be unreliable. The regulator is located behind the instrument panel. Vacuum pressure, even though set correctly, can read lower at very high altitude (above 12,000 ft), and at low engine RPM (usually on approach or during training maneuvers. This is normal and should not be considered a malfunction.

*Optional equipment

7.19 INSTRUMENT PANEL

The instrument panel (Figure 7-15) is designed to accommodate instruments and avionics equipment for VFR and IFR flights.

The radios and the circuit breakers are located on the upper and lower right panel respectively, and have circuits provided for the addition of optional radio equipment. An optional radio master switch is located near the top of the instrument panel between the radio stacks. It controls the power to all radios through the aircraft master switch. An emergency bus switch is also provided to provide auxiliary power to the avionics bus in event of a radio master switch circuit failure. The emergency bus switch is located behind the lower right shin guard left of the circuit breaker panel. An engine cluster is located to the right of the pilot control wheel and includes a fuel pressure gauge, a right and left main fuel quantity gauge, an oil temperature gauge and an oil pressure gauge.

Standard instruments include a compass, an airspeed indicator, a tachometer, an altimeter, an ammeter, an engine cluster, and an annunciator panel. The compass is mounted on the windshield bow in clear view of the pilot. The annunciator panel is mounted in the upper instrument panel to warn the pilot of a possible malfunction in the alternator, oil pressure, or vacuum systems.

Instrument options available for the panel includes a suction gauge, vertical speed indicator, attitude gyro, directional gyro, clock, true-speed indicator and a turn and slip indicator or turn coordinator. The attitude gyro and directional gyro are vacuum operated through the use of a vacuum pump installed on the engine, while the turn and slip indicator is electrically operated. The vacuum suction gauge is on the far right of the instrument panel.

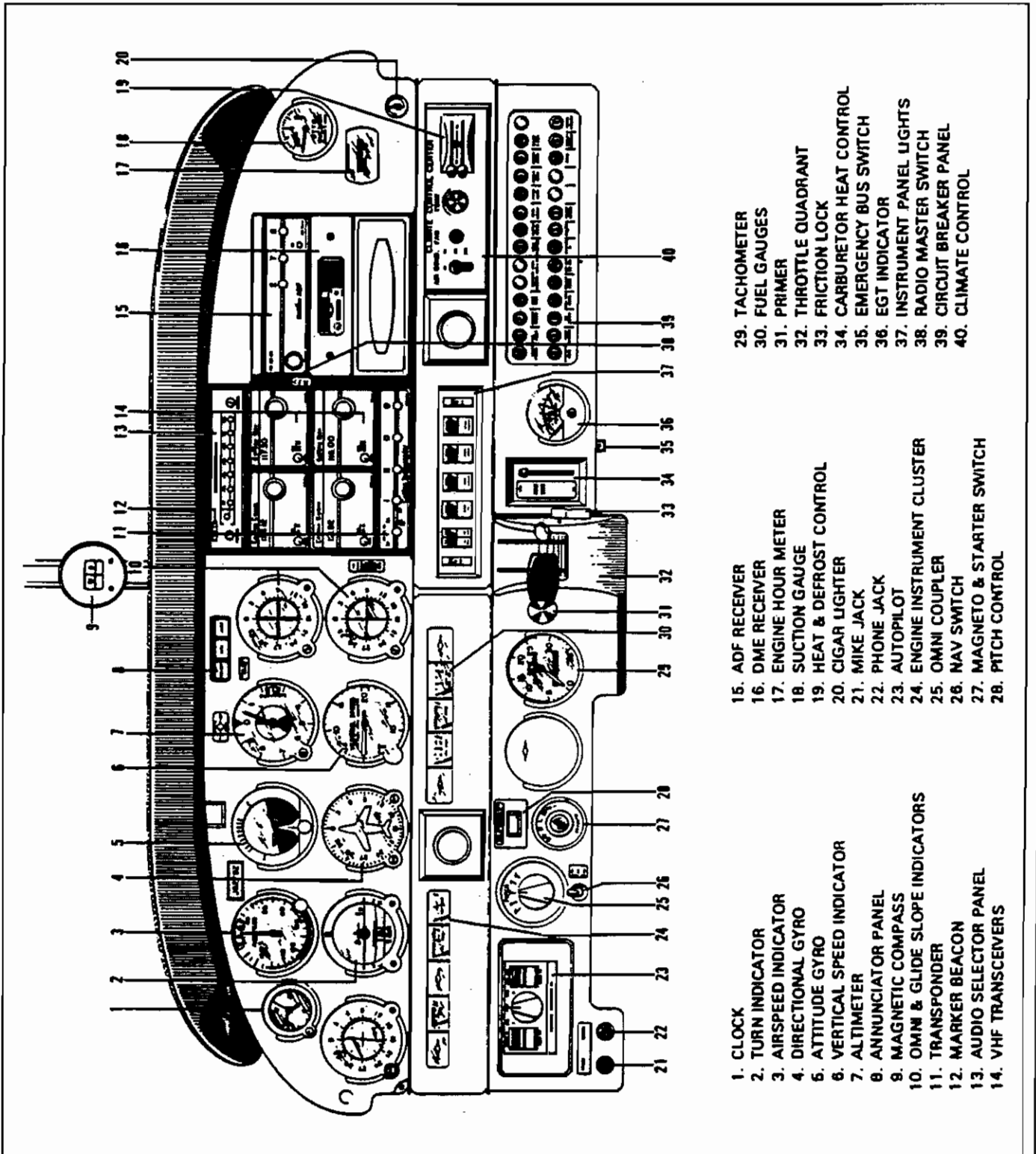

INSTRUMENT PANEL

Figure 7-15

7.21 PITOT-STATIC SYSTEM

The system supplies both pitot and static pressure for the airspeed indicator, altimeter, and the optional vertical speed indicator (Figure 7-17)

Pitot and static pressure are picked up by a pitot head installed on the bottom of the left wing and carried through pitot and static lines within the wing and fuselage to the gauges on the instrument panel.

An alternate static source is available as optional equipment. The control valve is located below the left side of the instrument panel. When the valve is set in the alternate position, the altimeter, vertical speed indicator and airspeed indicator will be using cabin air for static pressure. The storm window and cabin vents must be closed and the cabin heater and defroster must be on during alternate static source operation. The altimeter error is less than 50 feet unless otherwise placarded.

Both the pitot and static lines can be drained through separate drain valves located on the left lower side of the fuselage interior.

A heated pitot head, which alleviates problems with icing and heavy rain, is available as optional equipment. The switch for the heated pitot head is located on the electrical switch panel to the left of the right control wheel.

To prevent bugs and water from entering the pitot and static pressure holes, a cover should be placed over the pitot head. A partially or completely blocked pitot head will give erratic or zero readings on the instruments.

NOTE

During the preflight, check to make sure the pitot cover is removed.

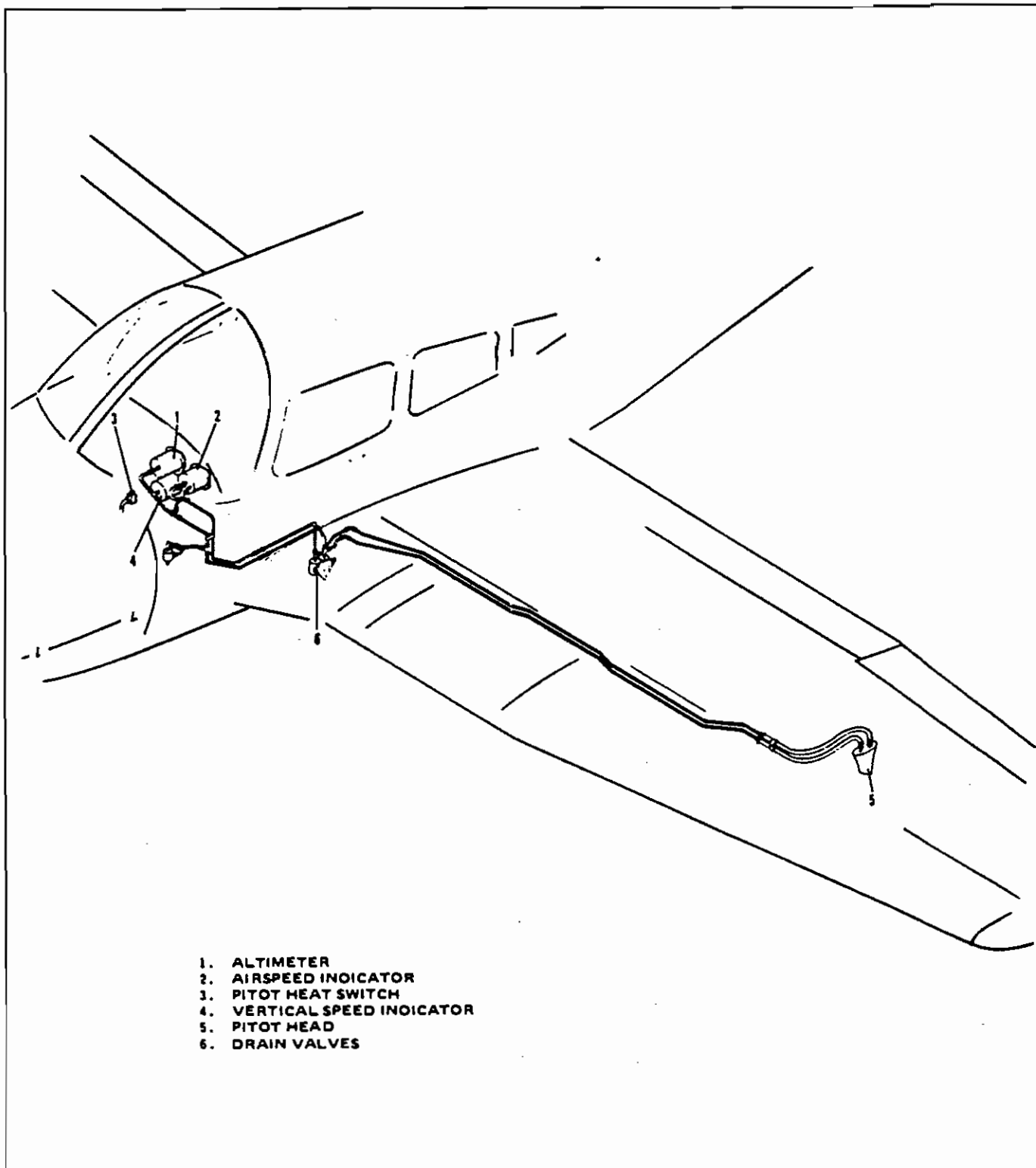

PITOT-STATIC SYSTEM

Figure 7-17

SECTION 7
DESCRIPTION AND OPERATION

PIPER AIRCRAFT CORPORATION
PA-28-161, CHEROKEE WARRIOR II

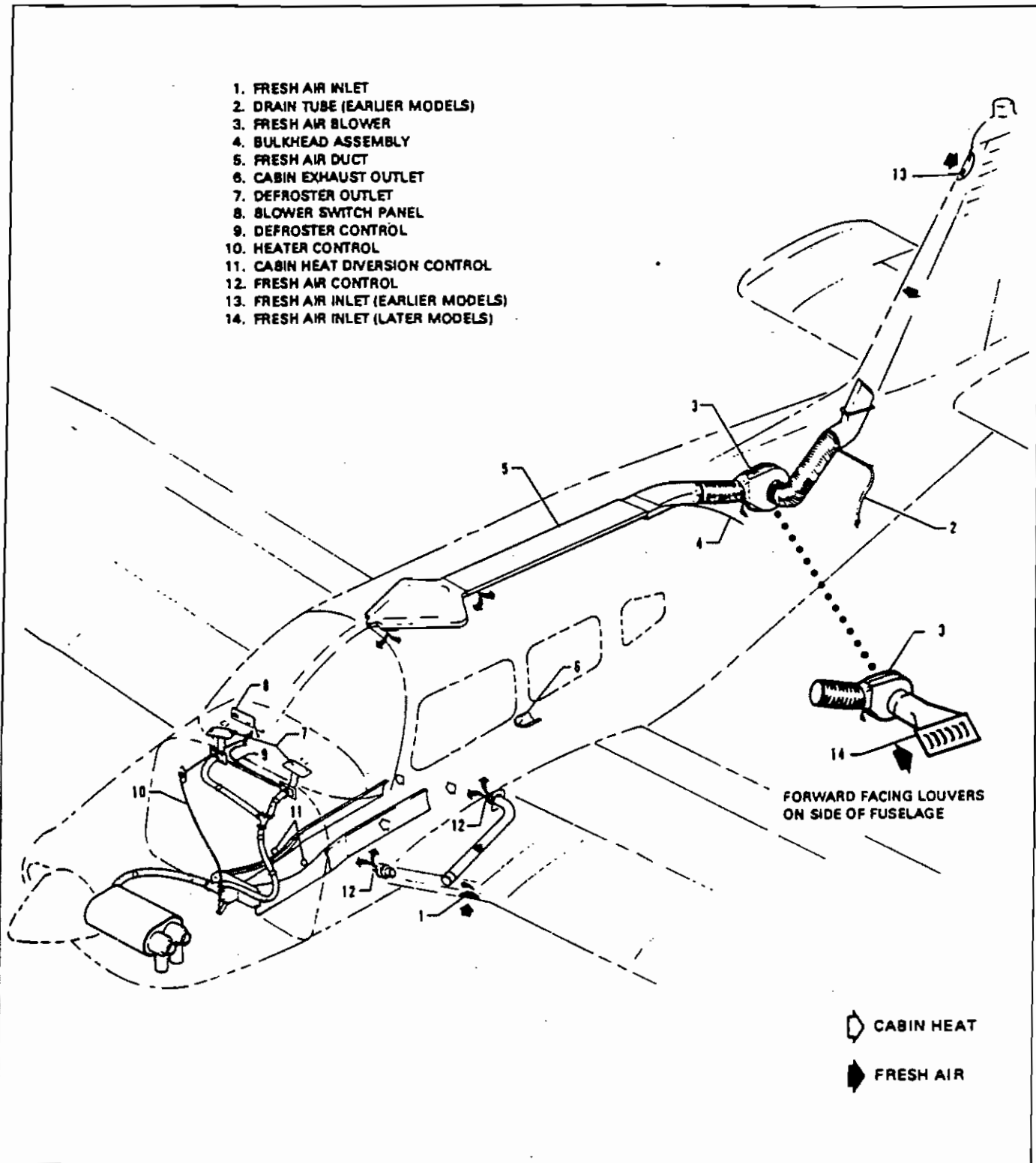

HEATING AND VENTILATING SYSTEM

Figure 7-19

7.23 HEATING AND VENTILATING SYSTEM

Heat for the cabin interior and the defroster system is provided by a shroud attached to the muffler (Figure 7-19). The amount of heat can be regulated with the controls located on the far right side of the instrument panel.

The airflow between front and rear seats can be regulated by the heat diversion controls located on either side of the console atop the heat ducts.

CAUTION

When cabin heat is operated, heat duct surface becomes hot. This could result in burns if arms or legs are placed too close to heat duct outlets or surface.

Fresh air inlets are located in the leading edges of the wings near the fuselage. At each front seat location there is an adjustable fresh air outlet on the side of the cabin near the floor. Rear seat vents are optional. Cabin air is exhausted through an outlet located below the rear seat.

An optional overhead ventilating system with outlets over each seat is also available. An additional option to aid in fresh air circulation on models without air conditioning is a cabin air blower to force air through the overhead vent system. This blower is operated by a fan switch with four positions - "OFF," "LOW," "MED," and "HIGH." The switch is located on the right side of the instrument panel with the heater and defroster controls.

7.25 CABIN FEATURES

For ease of entry and exit and for pilot-passenger comfort, the front seats are adjustable fore and aft. The right front seat tilts forward to allow easy entry to the rear seats. The cabin interior includes a pilot storm window, ash trays and armrests on each front seat, two map pockets and pockets on the backs of the front seats.

The front seats can be equipped with optional headrests and optional vertical adjustment.

Seat belts are standard equipment for both front and rear seats. A single strap adjustable shoulder harness located above the side window, protects each front seat occupant. Optional shoulder straps for the rear seat occupants are available. The shoulder strap is routed over the shoulder adjacent to the window and attached to the lap belt in the general area of the occupant's inboard hip. Adjust this fixed strap so that all controls are accessible while maintaining adequate restraint for the occupant. Shoulder harness with inertial reels are available for all four seats.

A check of the inertia reel mechanism is made by pulling sharply on the strap. The reel should lock in place under this test and prevent the strap from extending. For normal body movements, the strap will extend or retract as required.

7.27 BAGGAGE AREA

A 24 cubic foot baggage area, located behind the rear seat, is accessible from the cabin or loaded through a large 20 x 22 inch outside baggage door on the right side of the fuselage. Maximum capacity is 200 pounds. Tie-down straps are available and they should be used at all times.

NOTE

It is the pilot's responsibility to be sure when the baggage is loaded that the aircraft C.G. falls within the allowable C.G. range. (See Weight and Balance Section.)

7.29 STALL WARNING

An approaching stall is indicated by an audible alarm located behind the instrument panel. The indicator activates at between five and ten knots above stall speed.

7.31 FINISH

All exterior surfaces are primed with etching primer and finished with acrylic lacquer. To keep the finish attractive, economy size spray cans of touch-up paint are available from Piper Dealers.

An optional polyurethane finish is available.

7.33 PIPER EXTERNAL POWER*

An optional starting installation known as Piper External Power (PEP) is accessible through a receptacle located on the right side of the fuselage aft of the baggage door. An external battery can be connected to the socket, thus allowing the operator to crank the engine without having to gain access to the airplane's battery. Instructions on a placard located on the cover of the receptacle should be followed before using the external power. For instructions on the use of the PEP see; STARTING WITH EXTERNAL POWER SOURCE in Section 4 - Normal Operating Procedures.

7.35 EMERGENCY LOCATOR TRANSMITTER*

The Emergency Locator Transmitter (ELT) when installed, is located in the aft portion of the fuselage just below the stabilator leading edge and is accessible through a plate on the right side of the fuselage. This plate is attached with slotted-head nylon screws for ease of removal; these screws may be readily removed with a variety of common items such as a dime, a key, a knife blade, etc. If there are no tools available in an emergency the screw heads may be broken off by any means. The ELT is an emergency locator transmitter which meets the requirements of FAR 91.52.

A battery replacement date is marked on the transmitter to comply with FAA regulations, the battery must be replaced on or before this date. The battery must also be replaced if the transmitter has been used in an emergency situation or if the accumulated test time exceeds one hour, or if the unit has been inadvertently activated for an undetermined time period.

NOTE

If for any reason a test transmission is necessary, the test transmission should be conducted only in the first five minutes of any hour and limited to three audio sweeps. If the tests must be made at any other time, the tests should be coordinated with the nearest FAA tower or flight service station.

NARCO ELT 10 OPERATION

On the ELT unit itself is a three position switch placarded "ON," "OFF" and "ARM." The ARM position sets the ELT so that it will transmit after impact and will continue to transmit until its battery is drained. The ARM position is selected when the ELT is installed in the airplane and it should remain in that position.

To use the ELT as a portable unit in an emergency, remove the cover and unlatch the unit from its mounting base. The antenna cable is disconnected by a left quarter-turn of the knurled nut and a pull. A sharp tug on the two small wires will break them loose. Deploy the self-contained antenna by pulling the plastic tab marked "PULL FULLY TO EXTEND ANTENNA." Move the switch to ON to activate the transmitter.

In the event the transmitter is activated by an impact, it can only be turned off by moving the switch on the ELT unit to OFF. Normal operation can then be restored by pressing the small clear plastic reset button located on the top of the front face of the ELT and then moving the switch to ARM.

A pilot's remote switch located on the left side panel is provided to allow the transmitter to be turned on from inside the cabin. The pilot's remote switch is placarded "ON" and "ARMED." The switch is normally in the ARMED position. Moving the switch to ON will activate the transmitter. Moving the switch back to the ARMED position will turn off the transmitter only if the impact switch has not been activated.

*Optional equipment.

**SECTION 7
DESCRIPTION AND OPERATION**

**PIPER AIRCRAFT CORPORATION
PA-28-161, CHEROKEE WARRIOR II**

The ELT should be checked to make certain the unit has not been activated during the ground check. Check by selecting 121.50 MHz on an operating receiver. If there is an oscillating chirping sound, the ELT may have been activated and should be turned off immediately. This requires removal of the access cover and moving the switch to OFF, then press the reset button and return the switch to ARM. Recheck with the receiver to ascertain the transmitter is silent.

CCC CIR 11-2 OPERATION

On the unit itself is a three position selector switch placarded "OFF," "ARM" and "ON." The ARM position is provided to set the unit to the automatic position so that it will transmit only after impact and will continue to transmit until the battery is drained to depletion or until the switch is manually moved to the OFF position. The ARM position is selected when the transmitter is installed at the factory and the switch should remain in that position whenever the unit is installed in the airplane. The ON position is provided so the unit can be used as a portable transmitter or in the event the automatic feature was not triggered by impact or to periodically test the function of the transmitter.

Select the OFF position when changing the battery, when rearming the unit if it has been activated for any reason, or to discontinue transmission.

NOTE

If the switch has been placed in the ON position for any reason, the OFF position has to be selected before selecting ARM. If ARM is selected directly from the ON position, the unit will continue to transmit in the ARM position.

A pilot's remote switch, located on the left side panel, is provided to allow the transmitter to be controlled from inside the cabin. The pilot's remote switch is placarded "ON," "AUTO/ARM" and "OFF/RESET." The switch is normally left in the AUTO/ARM position. To turn the transmitter off, move the switch momentarily to the OFF/RESET position. The aircraft master switch must be ON to turn the transmitter OFF. To actuate the transmitter for tests or other reasons, move the switch upward to the ON position and leave it in that position as long as transmission is desired.

The unit is equipped with a portable antenna to allow the locator to be removed from the aircraft in case of an emergency and used as a portable signal transmitter.

The locator should be checked during the ground check to make certain the unit has not been accidentally activated. Check by tuning a radio receiver to 121.50 MHz. If there is an oscillating sound, the locator may have been activated and should be turned off immediately. Reset to the ARM position and check again to insure against outside interference.

7.37 AIR CONDITIONING*

The air conditioning system is a recirculating air system. The major items include: evaporator, condenser, compressor, blower, switches and temperature controls.

The evaporator is located behind the left rear side of the baggage compartment. This cools the air that is used for air conditioning.

The condenser is mounted on a retractable scoop located on the bottom of the fuselage and to the rear of the baggage compartment area. The scoop extends when the air conditioner is "ON" and retracts to a flush position when the system is "OFF."

The compressor is mounted on the forward right underside of the engine. It has an electric clutch which automatically engages or disengages the compressor to the belt drive system of the compressor.

An electrical blower is mounted on the aft side of the rear cabin panel. Air from the baggage area is drawn through the evaporator by the blower and distributed through an overhead duct to individual outlets located adjacent to each occupant.

The switches and temperature control are located on the lower right side of the instrument panel in the climate control center panel. The temperature control regulates the desired temperature of the cabin. Turn the control clockwise for increased cooling, counterclockwise for decreased cooling.

Located inboard of the temperature control is the fan speed switch and the air conditioning "ON-OFF" switch. The fan can be operated independently of the air conditioning. However, it must be on for air conditioner operation. Turning either switch off will disengage the compressor clutch and retract the condenser door. Cooling air should be felt within one minute after the air conditioner is turned on.

NOTE

If the system is not operating in 5 minutes, turn the system "OFF" until the fault is corrected.

The "FAN" switch allows operation of the fan with the air conditioner turned "OFF" to aid cabin air circulation if desired. A "LOW," "MED" or "HIGH" flow of air can be selected to the air conditioner outlets located in the overhead duct. The outlets can be adjusted or turned off by each occupant to regulate individual cooling effect.

The "DOOR OPEN" indicator light is located to the left of the radio stack in front of the pilot. The light illuminates whenever the condenser door is open and remains on until the door is closed.

A circuit breaker located on the circuit breaker panel protects the air conditioning electrical system.

Whenever the throttle is in the full throttle position, it actuates a micro switch which disengages the compressor and retracts the scoop. This is done to obtain maximum power and maximum rate of climb. The fan continues to operate and the air will remain cool for approximately one minute. When the throttle is retarded approximately 1/4 inch, the clutch will engage and the scoop will extend, again supplying cool, dry air.

*Optional equipment

7.39 CARBURETOR ICE DETECTION SYSTEM*

A carburetor ice detection system is available as optional equipment.

The system consists of a control box mounted on instrument panel, a probe sensor mounted in the carburetor and a red warning light to indicate the presence of ice in the carburetor. If ice is present apply full carburetor heat. Refer to 3.28. Carburetor Icing, in the emergency procedures. To adjust the system for critical ice detection, first turn on the airplanes master switch and then turn on the ice detection unit. Turn the sensitivity knob fully counter clockwise causing the carb ice light to come on. Now rotate the sensitivity knob back (clockwise) until the ice light just goes out. This establishes the critical setting.

WARNING

This instrument is approved as optional equipment only and Flight Operations should not be predicated on its use.

*Optional equipment

TABLE OF CONTENTS
SECTION 8
AIRPLANE HANDLING, SERVICING AND MAINTENANCE

Paragraph No.		Page No.
8.1	General	8-1
8.3	Airplane Inspection Periods	8-3
8.5	Preventive Maintenance	8-4
8.7	Airplane Alterations	8-5
8.9	Ground Handling.....	8-6
8.11	Engine Air Filter	8-8
8.13	Brake Service	8-8
8.15	Landing Gear Service.....	8-10
8.17	Propeller Service	8-11
8.19	Oil Requirements	8-11
8.21	Fuel System.....	8-11
8.23	Tire Inflation	8-14
8.25	Battery Service	8-14
8.27	Cleaning	8-14
8.29	Cold Weather Operation.....	8-16

SECTION 8

AIRPLANE HANDLING, SERVICING, AND MAINTENANCE

8.1 GENERAL

This section provides guidelines relating to the handling, servicing, and maintenance of the Cherokee Warrior II. For complete maintenance instructions, refer to the PA-28 Service Manual.

Every owner should stay in close contact with an authorized Piper Service Center or Piper's Customer Services Department to obtain the latest information pertaining to their airplane, and to avail themselves of Piper Aircraft's support systems.

Piper Aircraft Corporation takes a continuing interest in having owners get the most efficient use from their airplane and keeping it in the best mechanical condition. Consequently, Piper Aircraft, from time to time, issues service releases including Service Bulletins, Service Letters, Service Spares Letters, and others relating to the airplane.

Piper Service Bulletins are of special importance and Piper considers compliance mandatory. These are sent directly to the latest FAA-registered owners in the United States (U.S.) and Piper Service Centers worldwide. Depending on the nature of the release, material and labor allowances may apply. This information is provided to all authorized Piper Service Centers.

Service Letters deal with product improvements and servicing techniques pertaining to the airplane. They are sent to Piper Service Centers and, if necessary, to the latest FAA-registered owners in the U.S. Owners should give careful attention to Service Letter information.

Service Spares Letters offer improved parts, kits, and optional equipment which were not available originally, and which may be of interest to the owner.

Piper Aircraft Corporation offers a subscription service for Service Bulletins, Service Letters, and Service Spares Letters. This service is available to interested persons such as owners, pilots, and mechanics at a nominal fee, and may be obtained through an authorized Piper Service Center or Piper's Customer Services Department.

Maintenance manuals, parts catalogs, and revisions to both, are available from Piper Service Centers or Piper's Customer Services Department.

Any correspondence regarding the airplane should include the airplane model and serial number to ensure proper response.

THIS PAGE INTENTIONALLY LEFT BLANK

8.3 AIRPLANE INSPECTION PERIODS

Piper Aircraft Corporation has developed inspection items and required inspection intervals for the PA-28 (see PA-28 Service and Inspection Manual). The PA-28 Inspection Manual contains appropriate forms, and all inspection procedures should be complied with by a properly trained, knowledgeable, and qualified mechanic at a Piper Authorized Service Center or a reputable repair shop. Piper Aircraft Corporation cannot accept responsibility for the continued airworthiness of any aircraft not maintained to these standards, and/or not brought into compliance with applicable Service Bulletins issued by Piper Aircraft Corporation, instructions issued by the engine, propeller, or accessory manufacturers, or Airworthiness Directives issued by the FAA.

A programmed Inspection, approved by the Federal Aviation Administration (FAA), is also available to the owner. This involves routine and detailed inspections to allow maximum utilization of the airplane. Maintenance inspection costs are reduced, and the maximum standard of continued airworthiness is maintained. Complete details are available from Piper Aircraft Corporation.

In addition, but in conjunction with the above, the FAA requires periodic inspections on all aircraft to keep the Airworthiness Certificate in effect. The owner is responsible for assuring compliance with these inspection requirements and for maintaining proper documentation in logbooks and/or maintenance records.

A spectrographic analysis of the engine oil is available from several sources. This inspection, if performed properly, provides a good check of the internal condition of the engine. To be accurate, induction air filters must be cleaned or changed regularly, and oil samples must be taken and sent in at regular intervals.

8.5 PREVENTIVE MAINTENANCE

The holder of a pilot certificate issued under Federal Aviation Regulations (FAR) Part 61 may perform certain preventive maintenance as defined in the FARs. This maintenance may be performed only on an aircraft which the pilot owns and operates, and which is not used in air carrier or air taxi/commercial operations service.

All other aircraft maintenance must be accomplished by a person or facility appropriately certificated by the Federal Aviation Administration (FAA) to perform that work.

Anytime maintenance is accomplished, an entry must be made in the appropriate aircraft maintenance records. The entry shall include:

- (a) The date the work was accomplished.
- (b) Description of the work.
- (c) Number of hours on the aircraft.
- (d) The certificate number of pilot performing the work.
- (e) Signature of the individual doing the work.

8.7 AIRPLANE ALTERATIONS

If the owner desires to have his aircraft modified, he must obtain FAA approval for the alteration. Major alterations accomplished in accordance with Advisory Circular 43.13-2, when performed by an A & P mechanic, may be approved by the local FAA office. Major alterations to the basic airframe or systems not covered by AC 43.13-2 require a Supplemental Type Certificate.

The owner or pilot is required to ascertain that the following Aircraft Papers are in order and in the aircraft.

- (a) To be displayed in the aircraft at all times:
 - (1) Aircraft Airworthiness Certificate Form FAA-8100-2.
 - (2) Aircraft Registration Certificate Form FAA-8050-3.
 - (3) Aircraft Radio Station License if transmitters are installed.

- (b) To be carried in the aircraft at all times:
 - (1) Pilot's Operating Handbook.
 - (2) Weight and Balance data plus a copy of the latest Repair and Alteration Form FAA-337, if applicable.
 - (3) Aircraft equipment list.

Although the aircraft and engine logbooks are not required to be in the aircraft, they should be made available upon request. Logbooks should be complete and up to date. Good records will reduce maintenance cost by giving the mechanic information about what has or has not been accomplished.

8.9 GROUND HANDLING

(a) Towing

The airplane may be moved on the ground by the use of the nose wheel steering bar that is stowed below the forward ledge of the baggage compartment or by power equipment that will not damage or excessively strain the nose gear steering assembly. Towing lugs are incorporated as part of the nose gear fork.

CAUTION

When towing with power equipment, do not turn the nose gear beyond its steering radius in either direction, as this will result in damage to the nose gear and steering mechanism.

CAUTION

Do not tow the airplane when the controls are secured.

In the event towing lines are necessary, ropes should be attached to both main gear struts as high up on the tubes as possible. Lines should be long enough to clear the nose and/or tail by not less than fifteen feet, and a qualified person should ride in the pilot's seat to maintain control by use of the brakes.

(b) Taxiing

Before attempting to taxi the airplane, ground personnel should be instructed and approved by a qualified person authorized by the owner. Engine starting and shut-down procedures as well as taxi techniques should be covered. When it is ascertained that the propeller back blast and taxi areas are clear, power should be applied to start the taxi roll, and the following checks should be performed:

- (1) Taxi a few feet forward and apply the brakes to determine their effectiveness.
- (2) While taxiing, make slight turns to ascertain the effectiveness of the steering.
- (3) Observe wing clearance when taxiing near buildings or other stationary objects. If possible, station an observer outside the airplane.
- (4) When taxiing over uneven ground, avoid holes and ruts.
- (5) Do not operate the engine at high RPM when running up or taxiing over ground containing loose stones, gravel, or any loose material that may cause damage to the propeller blades.

(c) Parking

When parking the airplane, be sure that it is sufficiently protected from adverse weather conditions and that it presents no danger to other aircraft. When parking the airplane for any length of time or overnight, it is suggested that it be moored securely.

- (1) To park the airplane, head it into the wind if possible.
- (2) Set the parking brake by pulling back on the brake lever and depressing the knob on the handle. To release the parking brake, pull back on the handle until the catch disengages; then allow the handle to swing forward.

CAUTION .

Care should be taken when setting brakes that are overheated or during cold weather when accumulated moisture may freeze a brake.

- (3) Aileron and stabilator controls should be secured with the front seat belt and chocks used to properly block the wheels.

(d) Mooring

The airplane should be moored for immovability, security and protection. The following procedures should be used for the proper mooring of the airplane:

- (1) Head the airplane into the wind if possible.
- (2) Retract the flaps.
- (3) Immobilize the ailerons and stabilator by looping the seat belt through the control wheel and pulling it snug.
- (4) Block the wheels.
- (5) Secure tie-down ropes to the wing tie-down rings and to the tail skid at approximately 45 degree angles to the ground. When using rope of non-synthetic material, leave sufficient slack to avoid damage to the airplane should the ropes contract.

CAUTION

Use bowline knots, square knots or locked slip knots. Do not use plain slip knots.

NOTE

Additional preparations for high winds include using tie-down ropes from the landing gear forks and securing the rudder.

- (6) Install a pitot head cover if available. Be sure to remove the pitot head cover before flight.
- (7) Cabin and baggage doors should be locked when the airplane is unattended.

8.11 ENGINE AIR FILTER

The wet-type polyurethane foam air filter must be inspected at least once every fifty hours. Under extremely adverse operating conditions, it may be necessary to inspect the filter more frequently. The filter is disposable and inexpensive and a spare should be kept on hand for a rapid replacement.

(a) Removal Of Engine Air Filter

The filter is located in the lower right front of the engine compartment and may be removed by the following procedure:

- (1) Open the right side of the engine cowling.
- (2) Loosen each of the four quarter-turn fasteners securing the air filter cover.
- (3) Separate the cover and remove the filter.
- (4) Inspect the filter. If it is excessively dirty or shows any damage, replace it immediately.

(b) Installation Of Engine Air Filter

When replacing the filter, install the filter in the reverse order of removal.

8.13 BRAKE SERVICE

The brake system is filled with MIL-H-5606 (petroleum base) hydraulic brake fluid. The fluid level should be checked periodically or at every 50 hour inspection and replenished when necessary. The brake reservoir is located on the fire wall in the engine compartment. If the entire system must be refilled, fill with fluid under pressure from the brake end of the system. This will eliminate air from the system.

No adjustment of the brake clearances is necessary. If after extended service brake blocks become excessively worn, they should be replaced with new segments.

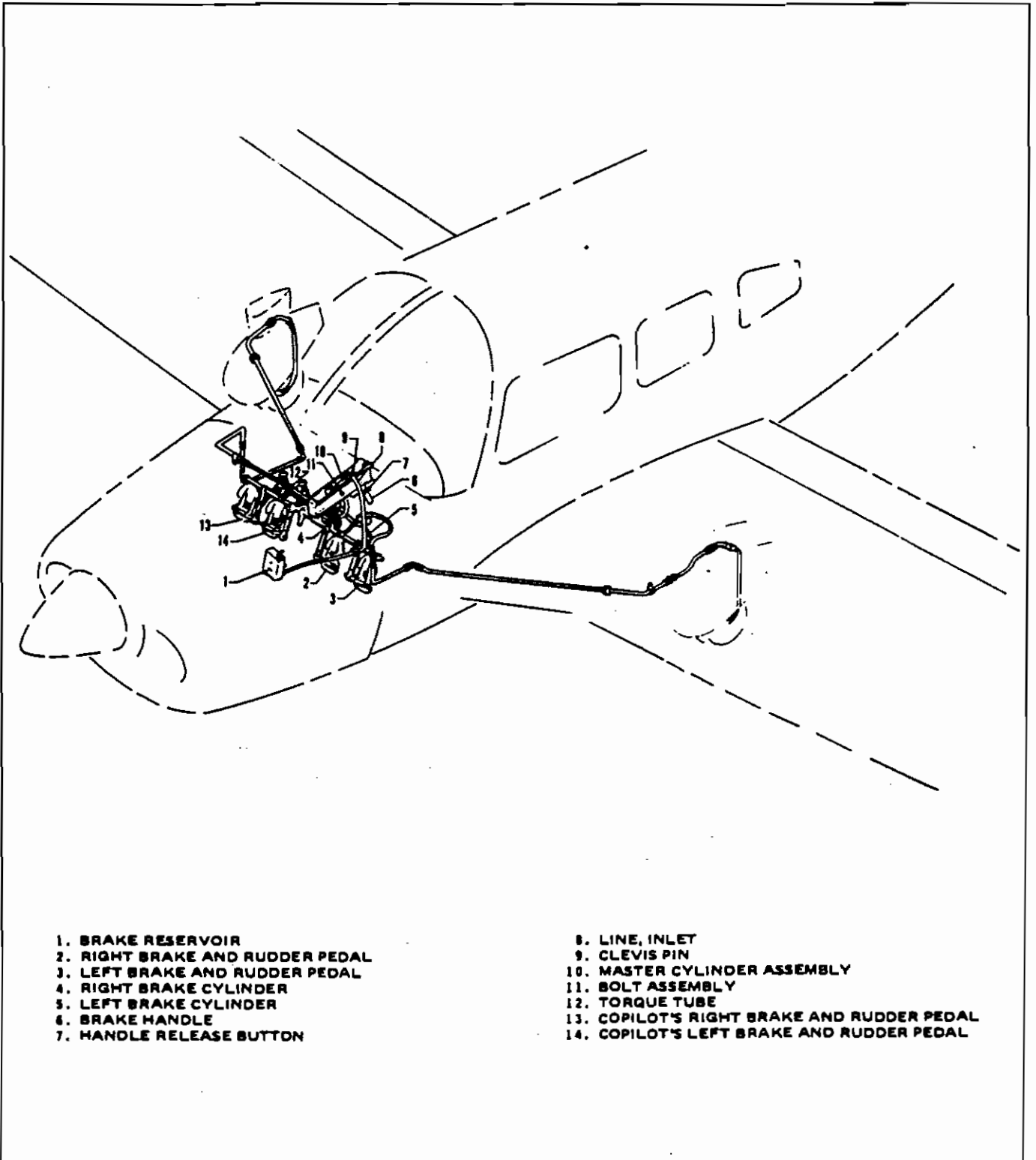

BRAKE SYSTEM

Figure 8-1

8.15 LANDING GEAR SERVICE

The main landing gears use 6.00 x 6 wheels and the nose gear carries a 5.00 x 5 wheel. All three tires are four-ply rating, type III tires with tubes. (Refer to paragraph 8.23).

Wheels are removed by taking off the hub cap, cotter pin, axle nut, and the two bolts holding the brake segment in place. Mark tire and wheel for reinstallation; then ~~dismount~~ by deflating the tire, removing the three through-bolts from the wheel and separating the wheel halves.

Landing gear oleos should be serviced according to the instructions on the units. The main oleos should be extended under normal static load until $4.50 \pm .25$ inches of oleo piston tube is exposed, and the nose gear should show $3.25 \pm .25$ inches. Should the strut exposure be below that required, it should be determined whether air or oil is required by first raising the airplane on jacks; Depress the valve core to allow air to escape from the strut housing chamber. Remove the filler plug and slowly raise the strut to full compression. If the strut has sufficient fluid, it will be visible up to the bottom of the filler plug hole and will then require only proper inflation.

Should fluid be below the bottom of the filler plug hole, oil should be added. Replace the plug with valve core removed; attach a clear plastic hose to the valve stem of the filler plug and submerge the other end in a container of hydraulic fluid. Fully compress and extend the strut several times, thus drawing fluid from the container and expelling air from the strut chamber. To allow fluid to enter the bottom chamber of the main gear strut housing, the torque link assembly must be disconnected to let the strut be extended a minimum of 10 inches (the nose gear torque links need not be disconnected). Do not allow the strut to extend more than 12 inches. When air bubbles cease to flow through the hose, compress the strut fully and again check fluid level. Reinstall the valve core and filler plug, and the main gear torque links, if disconnected.

With fluid in the strut housing at the correct level, attach a strut pump to the air valve and with the airplane on the ground, inflate the oleo strut to the correct height.

In jacking the aircraft for landing gear or other service, two hydraulic jacks and a tail stand should be used. At least 250 pounds of ballast should be placed on the base of the tail stand before the airplane is jacked up. The hydraulic jacks should be placed under the jack points on the bottom of the wing and the airplane jacked up until the tail skid is at the right height to attach the tail stand. After the tail stand is attached and the ballast added, jacking may be continued until the airplane is at the height desired.

The steering arms from the rudder pedals to the nose wheel are adjusted at the nose wheel by turning the threaded rod end bearings in or out. Adjustment is normally accomplished at the forward end of the rods and should be done in such a way that the nose wheel is in line with the fore and aft axis of the plane when the rudder pedals and rudder are centered. Alignment of the nose wheel can be checked by pushing the airplane back and forth with the rudder centered to determine that the plane follows a perfectly straight line. The turning arc of the nose wheel is $30.0^\circ \pm 2^\circ$ in either direction and is limited by stops on the bottom of the forging.

The rudder pedal arm stops should be carefully adjusted so that the pedal arms contact the stops just after the rudder hits its stops. This guarantees that the rudder will be allowed to move through its full ravel.

8.17 PROPELLER SERVICE

The spinner and backing plate should be cleaned and inspected for cracks. Before each flight the propeller should be inspected for nicks, scratches, and corrosion. If found, they should be repaired as soon as possible by a rated mechanic, since a nick or scratch causes an area of increased stress which can lead to serious cracks or the loss of a propeller tip. The back face of the blades should be painted when necessary with flat black paint to retard glare. To prevent corrosion, the surface should be cleaned and waxed periodically.

8.19 OIL REQUIREMENTS

The oil capacity of engine is 8 quarts, and the minimum safe quantity is 2 quarts. It is recommended that engine oil be drained and renewed every 50 hours. The oil filter element should be changed every 50 hours of operation. The interval between oil and oil filter changes should not exceed a total of four (4) months. Under unfavorable dusty conditions, the oil and oil filter should be changed more frequently.

The following seasonal aviation oil grades and seasonal ambient temperature ranges are recommended.

Average Ambient Temperature	MIL-L-6082B SAE Grade	MIL-L-22851 Ashless Dispersant SAE Grades
All Temperatures	—	15W-50 or 20W-50
Above 80°F	60	60
Above 60°F	50	40 or 50
30°F to 90°F	40	40
0°F to 70°F	30	30, 40 or 20W-40
Below 10°F	20	30 or 20W-30

When operating temperatures overlap indicated ranges, use the lighter grade oil.

NOTE

Refer to the latest issue of Textron Lycoming Service Instruction 1014 (Lubricating Recommendations) for further information.

8.21 FUEL SYSTEM

(a) Servicing Fuel System

At every 50 hour inspection, the fuel screens in the strainer, in the electric fuel pumps, and at the carburetor inlet must be cleaned.

(b) Fuel Requirements (AVGAS ONLY)

The minimum aviation grade fuel for the PA-28-161 is 100. Since the use of lower grades can cause serious engine damage in a short period of time, the engine warranty is invalidated by the use of lower octanes.

Whenever 100 or 100LL grade fuel is not available, commercial grade 100/130 should be used. (See Fuel Grade Comparison Chart, Page 8-12.) Refer to the latest issue of Lycoming Service Instruction No. 1070 for additional information.

A summary of the current grades as well as the previous fuel designations is shown in the following chart:

FUEL GRADE COMPARISON CHART

Previous Commercial Fuel Grades (ASTM-D910)			Current Commercial Fuel Grades (ASTM-D910-75)			Current Military Fuel Grades (MIL-G-5572E) Amendment No. 3		
Grade	Color	Max. TEL ml/U.S. gal.	Grade	Color	Max. TEL ml/U.S. gal.	Grade	Color	Max. TEL ml/U.S. gal.
80/87	red	0.5	80	red	0.5	80/87	red	0.5
91/98	blue	2.0	*100LL	blue	2.0	none	none	none
100/130	green	3.0	100	green	**3.0	100/130	green	**3.0
115/145	purple	4.6	none	none	none	115/145	purple	4.6

* - Grade 100LL fuel in some over seas countries is currently colored green and designated as 100L.

** - Commercial fuel grade 100 and grade 100/130 (both of which are colored green) having TEL content of up to 4 ml/U.S. gallon are approved for use in all engines certificated for use with grade 100/130 fuel.

The operation of the aircraft is approved with an anti-icing additive in the fuel. When anti-icing additive is used it must meet the specification MIL-I-27686, must be uniformly blended with the fuel while refueling, must not exceed 0.15% by volume of the refueled quantity, and to ensure its effectiveness should be blended at not less than 0.10% by volume. One and one half liquid ozs. per ten gallon of fuel would fall within this range. A blender supplied by the additive manufacturer should be used. Except for the information contained in this section, the manufacturer's mixing or blending instructions should be carefully followed.

CAUTION

Assure that the additive is directed into the flowing fuel stream. The additive flow should start after and stop before the fuel flow. Do not permit the concentrated additive to come in contact with the aircraft painted surfaces or the interior surfaces of the tanks.

Some fuels have anti-icing additives pre-blended in the fuel at the refinery, so no further blending should be performed.

Fuel additive can not be used as a substitute for preflight draining of the fuel system drains.

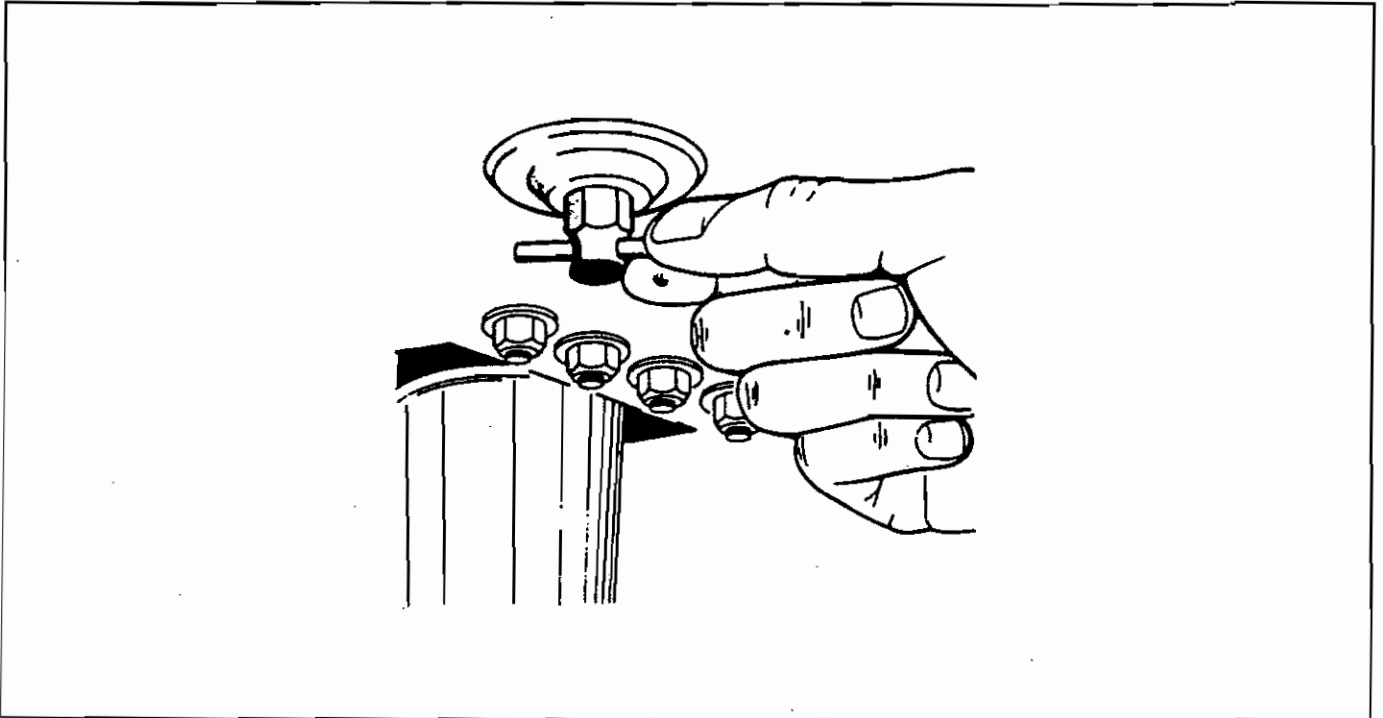

FUEL DRAIN

Figure 8-3

(c) Filling Fuel Tanks

Observe all required precautions for handling gasoline. Fuel is stored in two twenty-five gallon (24 usable) tanks.

(d) Draining Fuel Strainer, Sumps and Lines

The fuel system sumps and strainer should be drained daily prior to the first flight and after refueling to avoid the accumulation of contaminants such as water or sediment. Each fuel tank is equipped with an individual quick drain located at the lower inboard rear corner of the tank. The fuel strainer is equipped with a quick drain located on the front lower corner of the firewall. Each of the fuel tank sumps should be drained first. Then the fuel strainer should be drained twice, once with the fuel selector valve on each tank. Each time fuel is drained, sufficient fuel should be allowed to flow to ensure removal of contaminants. This fuel should be collected in a suitable container, examined for contaminants, and then discarded.

CAUTION

When draining any amount of fuel, care should be taken to ensure that no fire hazard exists before starting the engine.

After draining, each quick drain should be checked to make sure it has closed completely and is not leaking.

(e) Draining Fuel System

The bulk of the fuel may be drained from the system by opening valve at the inboard end of each fuel tank. Push up on the arms of the drain valve and turn counterclockwise to hold the drain open. The remaining fuel in the system may be drained through the filter bowl. Any individual tank may be drained by closing the selector valve and then draining the desired tank.

8.23 TIRE INFLATION

For maximum service from the tires, keep them inflated to the proper pressures - 30 psi for the nose gear and 24 psi for the main gear. All wheels and tires are balanced before original installation, and the relationship of tire, tube and wheel should be maintained upon reinstallation. Unbalanced wheels can cause extreme vibration in the landing gear; therefore, in the installation of new components, it may be necessary to rebalance the wheels with the tires mounted. When checking tire pressure, examine the tires for wear, cuts, bruises, and slippage.

8.25 BATTERY SERVICE

Access to the 12-volt battery is obtained by raising the rear seat and removing the cover of the battery box. The plastic battery box has a drain tube which is normally closed off with a cap and which should be opened occasionally to drain off any accumulation of liquid.

The battery should be checked for proper fluid level. DO NOT fill the battery above the baffle plates. DO NOT fill the battery with acid - use only water. A hydrometer check will determine the percent of charge in the battery.

If the battery is not up to charge, recharge starting at a 4 amp rate and finishing with a 2 amp rate. Quick charges are not recommended.

8.27 CLEANING

(a) Cleaning Engine Compartment

Before cleaning the engine compartment, place a strip of tape on the magneto vents to prevent any solvent from entering these units.

- (1) Place a large pan under the engine to catch waste.
- (2) With the engine cowling removed, spray or brush the engine with solvent or a mixture of solvent and degreaser. In order to remove especially heavy dirt and grease deposits, it may be necessary to brush areas that were sprayed.

CAUTION

Do not spray solvent into the alternator, vacuum pump, starter, or air intakes.

- (3) Allow the solvent to remain on the engine from five to ten minutes. Then rinse the engine clean with additional solvent and allow it to dry.

CAUTION

Do not operate the engine until excess solvent has evaporated or otherwise been removed.

- (4) Remove the protective tape from the magnetos.
- (5) Lubricate the controls, bearing surfaces, etc., in accordance with the Lubrication Chart.

(b) Cleaning Landing Gear

Before cleaning the landing gear, place a plastic cover or similar material over the wheel and brake assembly.

- (1) Place a pan under the gear to catch waste.
- (2) Spray or brush the gear area with solvent or a mixture of solvent and degreaser, as desired. Where heavy grease and dirt deposits have collected, it may be necessary to brush areas that were sprayed, in order to clean them.
- (3) Allow the solvent to remain on the gear from five to ten minutes. Then rinse the gear with additional solvent and allow to dry.
- (4) Remove the cover from the wheel and remove the catch pan.
- (5) Lubricate the gear in accordance with the Lubrication Chart.

(c) Cleaning Exterior Surfaces

The airplane should be washed with a mild soap and water. Harsh abrasives or alkaline soaps or detergents could make scratches on painted or plastic surfaces or could cause corrosion of metal. Cover areas where cleaning solution could cause damage. To wash the airplane, use the following procedure:

- (1) Flush away loose dirt with water.
- (2) Apply cleaning solution with a soft cloth, a sponge or a soft bristle brush.
- (3) To remove exhaust stains, allow the solution to remain on the surface longer.
- (4) To remove stubborn oil and grease, use a cloth dampened with naphtha.
- (5) Rinse all surfaces thoroughly.
- (6) Any good automotive wax may be used to preserve painted surfaces. Soft cleaning cloths or a chamois should be used to prevent scratches when cleaning or polishing. A heavier coating of wax on the leading surfaces will reduce the abrasion problems in these areas.

(d) Cleaning Windshield and Windows

- (1) Remove dirt, mud and other loose particles from exterior surfaces with clean water.
- (2) Wash with mild soap and warm water or with aircraft plastic cleaner. Use a soft cloth or sponge in a straight back and forth motion. Do not rub harshly.
- (3) Remove oil and grease with a cloth moistened with kerosene.

CAUTION

Do not use gasoline, alcohol, benzene, carbon tetrachloride, thinner, acetone, or window cleaning sprays.

- (4) After cleaning plastic surfaces, apply a thin coat of hard polishing wax. Rub lightly with a soft cloth. Do not use a circular motion.
- (5) A severe scratch or mar in plastic can be removed by rubbing out the scratch with jeweler's rouge. Smooth both sides and apply wax.

(e) Cleaning Headliner, Side Panels and Seats

- (1) Clean headliner, side panels, and seats with a stiff bristle brush, and vacuum where necessary.
- (2) Soiled upholstery, except leather, may be cleaned with a good upholstery cleaner suitable for the material. Carefully follow the manufacturer's instructions. Avoid soaking or harsh rubbing.

CAUTION

Solvent cleaners require adequate ventilation.

- (3) Leather should be cleaned with saddle soap or a mild hand soap and water.

(f) Cleaning Carpets

To clean carpets, first remove loose dirt with a whisk broom or vacuum. For soiled spots and stubborn stains use a nonflammable dry cleaning fluid. Floor carpets may be removed and cleaned like any household carpet.

8.29 COLD WEATHER OPERATION

For cold weather operation a winterization plate is installed on the inlet opening of the oil cooler. This plate should be installed whenever the ambient temperature reaches 50°F or less. The plate should be removed and stored in the cockpit when the ambient temperature exceeds 50°F.

It is recommended that an optional Engine Breather Tube Winterization Kit be installed for cold weather operation. This kit is available through your Piper Dealer/Distributor.

TABLE OF CONTENTS

SECTION 9

SUPPLEMENTS

Paragraph/ Supplement No.		Page No.
9.1	General	9-1
1	AutoFlite II Autopilot Installation	9-3
2	AutoControl IIIB Autopilot Installation	9-5
3	Piper Electric Pitch Trim.....	9-9
4	Air Conditioning Installation	9-11
5	Century 21 Autopilot	9-15
6	Piper Control Wheel Clock Installation	9-19

BLANK PAGE

**SECTION 9
SUPPLEMENTS**

9.1 GENERAL

This section provides information in the form of Supplements which are necessary for efficient operation of the airplane when equipped with one or more of the various optional systems and equipment not provided with the standard airplane.

All of the Supplements provided by this section are "FAA Approved" and consecutively numbered as a permanent part of this Handbook. The information contained in each Supplement applies only when the related equipment is installed in the airplane.

THIS PAGE INTENTIONALLY LEFT BLANK

SUPPLEMENT 1

AUTOFLITE II AUTOPILOT INSTALLATION

SECTION 1 - GENERAL

This supplement supplies information necessary for the operation of the airplane when the optional AutoFlite II Autopilot is installed. The information contained within this supplement is to be used in conjunction with the complete handbook.

This supplement has been "FAA Approved" as a permanent part of this handbook based on EDO-AIRE Mitchell STC SA3066SW-D and must remain in this handbook at all times when the optional AutoFlite II Autopilot is installed.

SECTION 2 - LIMITATIONS

- (a) Autopilot operation prohibited above 155 KIAS. (Autopilot Vmo)
- (b) Autopilot must be "OFF" for takeoff and landing.

SECTION 3 - EMERGENCY PROCEDURES

- (a) In case of malfunction, depress disconnect switch on pilot's control wheel, or overpower autopilot at either control wheel.
- (b) AutoFlite II master switch - OFF.
- (c) In climb, cruise or descent configuration a malfunction with a 3 second delay in recovery initiation may result in 60° bank and 320 foot altitude loss.
- (d) In approach configuration, coupled or uncoupled, a malfunction with a 1 second delay in recovery initiation may result in 15° bank and 20 foot altitude loss.

SECTION 4 - NORMAL PROCEDURES

AUTOFLITE II PREFLIGHT INSPECTION

- (a) AutoFlite II master switch - ON.
- (b) Rotate turn command knob to left and right. Aircraft control wheels should rotate in corresponding directions.
- (c) With AutoFlite II on, rotate aircraft control wheel to left and right. Only light forces should be required to override roll servo clutch.
- (d) AutoFlite II master switch - OFF - rotate control wheel left and right to assure disengagement.

AUTOFLITE II IN-FLIGHT PROCEDURE

- (a) Engagement
 - (1) Check turn command knob in center detent position.
 - (2) AutoFlite II master switch - ON.
- (b) Disengagement
 - (1) AutoFlite II master switch - OFF.
- (c) Heading Changes
 - (1) Move trim knob on instrument for drift correction from a constant heading.
 - (2) Move turn command knob for left or right banked turns. Rotation of knob to stop will yield an appropriate bank angle to obtain an approximate standard rate turn. Intermediate settings may be used for lesser turn rates.
- (d) OMNI Tracker
 - (1) Turn command knob - move to center detent position and push IN to engage tracker. Aircraft will track desired radial established on NAV 1 (or as selected, if equipped with a NAV selector switch).

NOTE

Tracker must be engaged within 10° of being "on course," i.e. VOR course needle centered and aircraft heading within 10° of VOR course.

- (2) Trim knob - push IN for high sensitivity. Use high sensitivity position for localizer tracking and as desired for OMNI tracking.
- (e) Maintain directional trim during all autopilot operations.

PERFORMANCE

No changes to the basic performance provided by Section 5 of this Pilot's Operating Handbook are necessary for this supplement.

SUPPLEMENT 2

AUTOCONTROL IIIB AUTOPILOT INSTALLATION

SECTION 1 - GENERAL

This supplement supplies information necessary for the operation of the airplane when the optional Piper AutoControl IIIB Autopilot is installed. The information contained within this supplement is to be used in conjunction with the complete handbook.

This supplement has been FAA Approved as a permanent part of this handbook based on EDO-AIRE Mitchell STC SA3065SW-D and must remain in this handbook at all times when the optional Piper AutoControl IIIB Autopilot is installed.

SECTION 2 - LIMITATIONS

- (a) Autopilot operation prohibited above 155 KIAS. (Autopilot VMO)
- (b) Autopilot must be OFF for takeoff and landing.

SECTION 3 - EMERGENCY PROCEDURES

- (a) In an emergency the AutoControl IIIB can be disconnected by:
 - (1) Pushing the A/P ON-OFF rocker switch - OFF.
- (b) The autopilot can be overpowered at either control wheel.
- (c) An autopilot runaway, with a 3 second delay in the initiation of recovery while operating in climb, cruise or descending flight, could result in a 60° bank and 320 foot altitude loss.
- (d) An autopilot runaway, with a 1 second delay in the initiation of recovery, during an approach operation, coupled or uncoupled, could result in an 15° bank and 20 foot altitude loss.
- (e) Emergency operation with optional NSD 360 and NSD 360A (HST) - Slaved and/or Non-Slaved:

NSD 360

- (1) Appearance of HDG Flag:
 - a. Check air supply gauge (vac or pressure) for adequate air supply (4 in. Hg. min.).
 - b. Check compass circuit breaker.
 - c. Observe display for proper operation.
- (2) To disable heading card - pull circuit breaker and use magnetic compass for directional data.

NOTE

If heading card is not operational, autopilot should not be used.

- (3) With card disabled:
 - a. VOR and Glide Slope displays are still functional; use card set to rotate card to aircraft heading for correct picture.
 - b. Localizer - left-right information still usable. Flag information is disabled - compare needle with No. 2 indicator for valid left-right needle operation.
- (4) Slaving Failure - (i.e. failure to self-correct for gyro drift):
 - a. Check gyro slaving switch is set to No. 1 position.
 - b. Check for HDG Flag.
 - c. Check compass circuit breaker.
 - d. Reset heading card while observing slaving meter.
 - e. Select slaving amplifier No. 2 (gyro slaving switch is set to No. 2 position).
 - f. Reset heading card while checking slaving meter.
 - g. Switch to free gyro and periodically set card as unslaved gyro.

NSD 360A (Instrument with red-white striped NAV-HDG Flags)

- (1) The emergency procedures for the NSD 360A remain identical to those listed for the NSD 360 (above), except that the presence of the NAV Flag on a localizer frequency invalidates the NAV left-right information. Usable navigation data will be indicated in both VOR and Localizer modes by the absence of the NAV Flag, whether the card is disabled or not.
- (2) In the localizer mode the "TO-FROM" arrows may remain out of view, depending upon the design of the NAV converter used in the installation.

SECTION 4 - NORMAL PROCEDURES

PREFLIGHT

- (a) AUTOPILOT
 - (1) Place radio coupler in HDG mode (if installed) and place the A/P "ON-OFF" switch to the "ON" position to engage roll section. Rotate roll command knob left and right and observe that control wheel describes a corresponding left and right turn, then center knob.
 - (2) Set proper D.G. heading on D.G. and turn HDG bug to aircraft heading. Engage HDG mode rocker switch and rotate HDG bug right and left. Aircraft control wheel should turn same direction as bug. Grasp control wheel and manually override servo, both directions.
- (b) RADIO COUPLER - (OPTIONAL)
 - (1) Tune and identify VOR or VOT station. Position radio coupler to OMNI mode. Engage autopilot "ON" and HDG switches. Set HDG bug to aircraft heading and rotate OBS to cause OMNI indicator needle to swing left and right slowly. Observe that control wheel rotates in direction of needle movement.
 - (2) Disengage A/P "ON-OFF" switch. Reset radio coupler control to HDG.

IN-FLIGHT

- (a) Trim airplane (ball centered).
- (b) Check air pressure or vacuum to ascertain that the directional gyro and attitude gyro are receiving sufficient air.

- (c) Roll Section:
- (1) To engage, center roll knob, push A/P "ON-OFF" switch to "ON" position. To turn, rotate console roll knob in desired direction. (Maximum angle of bank should not exceed 30°.)
 - (2) For heading mode, set directional gyro with magnetic compass. Push directional gyro HDG knob in, rotate bug to aircraft heading. Push console heading rocker (HDG) switch to "ON" position. To select a new aircraft heading, push D.G. heading knob "IN" and rotate, in desired direction of turn, to the desired heading.
- (d) Radio Coupling VOR-ILS with H.S.I. (Horizontal Situation Indicator) Type Instrument Display - (Optional)
- (1) VOR Navigation
 - a. Tune and identify VOR station. Select desired course by rotating CRS knob of H.S.I.
 - b. Select OMNI mode on radio coupler.
 - c. Select HDG mode on autopilot console to engage coupler. Aircraft will turn to a 45° intercept angle to intercept the selected VOR course. Intercept angle magnitude depends on radio needle off course magnitude, 100% needle deflection will result in 45° intercept with the intercept angle diminishing as the needle offset diminishes.
 - d. NAV mode - NAV mode provides reduced VOR sensitivity for tracking weak, or noisy VOR signals. NAV mode should be selected after the aircraft is established on course.
 - (2) ILS-LOC Front Course
 - a. Set inbound, front, localizer course on H.S.I.
 - b. Select LOC-Normal on radio coupler to intercept and track inbound on localizer. Select LOC-REV to intercept and track outbound to the procedure turn area.
 - c. Select HDG mode on autopilot console to engage coupler.
 - (3) ILS - Back Course
 - a. Set inbound, front localizer course on H.S.I.
 - b. Select LOC-REV on radio coupler to intercept and track inbound on the back localizer course. Select LOC-NORM to intercept and track outbound on the back course to the procedure turn area.
 - c. Select HDG mode on autopilot console to engage coupler.
- (e) Radio Coupling - VOR-ILS with standard directional gyro. (Optional)
- Radio coupler operation in conjunction with a standard directional gyro and VOR-LOC display differs from operation with an integrated display (H.S.I.) only in one respect. The HDG bug is used as the radio course datum and therefore must be set to match the desired VOR course as selected on the OBS.
- (1) For VOR intercepts and tracking:

Select the desired VOR course and set the HDG bug to the same heading. Select OMNI mode on the coupler and HDG mode on the autopilot console.
 - (2) For ILS Front Course intercepts and tracking:

Tune the localizer frequency and place the HDG bug on the inbound, front course heading. Select LOC-NORM mode on the coupler and HDG mode on the autopilot console.
 - (3) For LOC Back Course intercepts and tracking:

Tune the localizer frequency and place the HDG bug on the inbound course heading to the airport. Select LOC-REV mode with coupler and HDG mode on the autopilot console.

SECTION 5 - PERFORMANCE

No changes to the basic performance provided by Section 5 of the Pilot's Operating Handbook are necessary for this supplement.

SUPPLEMENT 3

PIPER ELECTRIC PITCH TRIM

SECTION 1 - GENERAL

This supplement supplies information necessary for the operation of the airplane when the optional Piper Electric Pitch Trim is installed. The information contained within this supplement is to be used in conjunction with the complete handbook.

This supplement has been FAA Approved as a permanent part of this handbook and must remain in this handbook at all times when the optional Piper Electric Pitch Trim is installed.

SECTION 2 - LIMITATIONS

No changes of the basic limitations provided by Section 2 of this Pilot's Operating Handbook are necessary for this supplement.

SECTION 3

- (a) In case of malfunction, disconnect electric pitch trim by advancing pitch trim switch on instrument panel to OFF position.
- (b) In an emergency, electric pitch trim may be overpowered using manual pitch trim.
- (c) In cruise configuration, malfunction results in 10° pitch change and 200 ft altitude variation.
- (d) In approach configuration, a malfunction can result in a 5° pitch change and 50 ft altitude loss.

SECTION 4 - NORMAL PROCEDURES

The electric trim system may be turned ON or OFF by a switch located above the ignition switch. The pitch trim may be changed when the electric trim system is turned on either by moving the manual pitch trim control wheel or by operating the trim control switch on the pilot's control yoke.

SECTION 5 - PERFORMANCE

No changes of the basic performance provided by Section 5 of this Pilot's Operating Handbook are necessary for this supplement.

THIS PAGE INTENTIONALLY LEFT BLANK

SUPPLEMENT 4

AIR CONDITIONING INSTALLATION

SECTION 1 - GENERAL

This supplement supplies information necessary for the efficient operation of the airplane when the optional air conditioning system is installed. The information contained within this supplement is to be used "as described" in conjunction with the complete handbook.

This supplement has been "FAA Approved" as a permanent part of this handbook and must remain in this handbook at all times when the optional air conditioning system is installed.

SECTION 2 - LIMITATIONS

- (a) To insure maximum climb performance the air conditioner must be turned "OFF" manually prior to takeoff to disengage the compressor and retract the condenser door. Also the air conditioner must be turned "OFF" manually before the landing approach in preparation for a possible go-around.
- (b) Placards
In full view of the pilot, in the area of the air conditioner controls when the air conditioner is installed:

"WARNING - AIR CONDITIONER MUST BE OFF TO INSURE
NORMAL TAKEOFF CLIMB PERFORMANCE."

In full view of the pilot, to the right of the engine gauges (condenser door light):

"AIR COND DOOR
OPEN"

SECTION 3 - EMERGENCY PROCEDURES

No changes to the basic Emergency Procedures provided by Section 3 of this Pilot's Operating Handbook are necessary for this supplement.

SECTION 4 - NORMAL PROCEDURES

Prior to takeoff, the air conditioner should be checked for proper operation as follows:

- (a) Check aircraft master switch "ON."
- (b) Turn the air conditioner control switch to "ON" and the fan switch to one of the operating positions - the "AIR COND DOOR OPEN" warning light will turn on, thereby indicating proper air conditioner condenser door actuation.
- (c) Turn the air conditioner control switch to "OFF" - the "AIR COND DOOR OPEN" warning light will go out, thereby indicating the air conditioner condenser door is in the up position.
- (d) If the "AIR COND DOOR OPEN" light does not respond as specified above, an air conditioner system or indicator bulb malfunction is indicated and further investigation should be conducted prior to flight.

The above operational check may be performed during flight if an in flight failure is suspected.

The condenser door light is located to the right of the engine instrument cluster in front of the pilot. The door light illuminates when the door is open and is off when the door is closed.

SECTION 5 - PERFORMANCE

Operation of the air conditioner will cause slight decreases in cruise speed and range. Power from the engine is required to run the compressor, and the condenser door, when extended, causes a slight increase in drag. When the air conditioner is turned off there is normally no measurable difference in climb, cruise or range performance of the airplane.

NOTE

To insure maximum climb performance the air conditioner must be turned off manually before takeoff to disengage the compressor and retract the condenser door. Also the air conditioner must be turned off manually before the landing approach in preparation for a possible go-around.

Although the cruise speed and range are only slightly affected by the air conditioner operation, these changes should be considered in preflight planning. To be conservative, the following figures assume that the compressor is operating continuously while the airplane is airborne. This will be the case only in extremely hot weather.

- (a) The decrease in true airspeed is approximately 4 KTS at all power settings.
- (b) The decrease in range may be as much as 32 nautical miles for the 48 gallon capacity.

The climb performance is not compromised measurably with the air conditioner operating since the compressor is declutched and the condenser door is retracted, both automatically, when a full throttle position is selected. When the full throttle position is not used or in the event of a malfunction which would cause the compressor to operate and the condenser door to be extended, a decrease in rate of climb of as much as 100 fpm can be expected. Should a malfunction occur which prevents condenser door retraction when the compressor is turned off, a decrease in rate of climb of as much as 50 fpm can be expected.

THIS PAGE INTENTIONALLY LEFT BLANK

SUPPLEMENT 5

CENTURY 21 AUTOPILOT INSTALLATION

SECTION 1 - GENERAL

This supplement supplies information necessary for the operation of the airplane when the optional Century 21 Autopilot is installed in accordance with STC SA3352SW. The information contained within this supplement is to be used in conjunction with the complete handbook.

This supplement has been "FAA Approved" as a permanent part of this handbook and must remain in this handbook at all times when the optional Century 21 Autopilot is installed.

SECTION 2 - LIMITATIONS

- (a) Autopilot operation prohibited above 155 KIAS.
- (b) Autopilot OFF during takeoff and landing.

SECTION 3 - EMERGENCY PROCEDURES

- (a) AUTOPILOT
In the event of an autopilot malfunction, or anytime the autopilot is not performing as commanded, do not attempt to identify the problem. Regain control of the aircraft by overpowering and immediately disconnecting the autopilot by depressing the AP ON-OFF switch on the programmer OFF.

Do not operate until the system failure has been identified and corrected.

- (1) Altitude Loss During Malfunction:
 - a. An autopilot malfunction during climb, cruise or descent with a 3 second delay in recovery initiation could result in as much as 60° of bank and 320' altitude loss. Maximum altitude loss was recorded at 155 KIAS during descent.
 - b. An autopilot malfunction during an approach with a 1 second delay in recovery initiation could result in as much as 15° bank and 20' altitude loss. Maximum altitude loss measured in approach configurations and operating either coupled or uncoupled.

- (b) COMPASS SYSTEM

- (1) Emergency Operation With Optional NSD 360A (HSI) Slaved and/or Non-Slaved:

- NSD 360A

- a. Appearance of HDG Flag:
 - 1. Check air supply gauge (vac or pressure) for adequate air supply (4 in. Hg. min.)
 - 2. Check compass circuit breaker.
 - 3. Observe display for proper operation.

- b. To disable heading card - pull circuit breaker and use magnetic compass for directional data.

NOTE

If heading card is not operational, autopilot should not be used.

- c. With card disabled VOR/Localizer and Glide Slope displays are still functional: use card set to rotate card to aircraft heading for correct picture.
- d. Slaving Failure - (i.e. failure to self correct for gyro drift):
 1. Check gyro slaving switch is set to No. 1 position (if equipped with Slave No. 1 - No. 2 switch) or "Slaved" position when equipped with Slaved and Free Gyro Mode Switch.
 2. Check for HDG Flag.
 3. Check compass circuit breaker.
 4. Reset heading card while observing slaving meter.

NOTE

Dead slaving meter needle or a needle displaced fully one direction indicates a slaving system failure.

5. Select slaving amplifier No. 2 if equipped.
6. Reset heading card while checking slaving meter. If proper slaving indication is not obtained, switch to free gyro mode and periodically set card as an unslaved gyro.

NOTE

In the localizer mode, the "TO-FROM" arrows may remain out of view, depending upon the design of the NAV converter used in the installation.

SECTION 4 - NORMAL PROCEDURES

Refer to Edo-Aire Mitchell Century 21 Autopilot Operator's Manual. P/N 68S805, dated 1-79 for Autopilot Description and Normal Operating Procedures.

(a) PREFLIGHT PROCEDURES

NOTE

During system functional check the system must be provided adequate D.C. voltage (12.0 VDC min.) and instrument air (4.2 in. Hg. min.). It is recommended that the engine be operated to provide the necessary power and that the aircraft be positioned in a level attitude, during the functional check.

(b) AUTOPILOT WITH STANDARD D.G.

- (1) Engage autopilot.
- (2) Control wheel movement should correspond to HDG command input.
- (3) Grasp control wheel and override roll servo actuator to assure override capability.

- (4) With HDG bug centered select NAV or APPR mode and note control wheel movement toward VOR needle offset.
 - (5) Select REV mode and note control wheel movement opposite VOR needle offset.
 - (6) Disengage autopilot.
 - (7) Check aileron controls through full travel to assure complete autopilot disengagement.
- (c) **AUTOPILOT WITH COMPASS SYSTEM (NSD 360A)**
(For other compass systems, refer to appropriate manufacturer's instructions)
- (1) Check slaving switch in slave or slave 1 or 2 position, as appropriate. (Slaving systems with R.M.I. output provide only slave and free gyro positions.)
 - (2) Rotate card to center slaving meter - check HDG displayed with magnetic compass HDG.
 - (3) Perform standard VOR receiver check.
 - (4) Perform Steps (1) - (7) in Section 4 item (b) except in Steps (4) and (5) substitute course arrow for HDG bug when checking control wheel movement in relation to L/R needle. HDG bug is inoperative with NAV, APPR, or REV mode selected.
- (d) **IN-FLIGHT PROCEDURE**
- (1) Trim aircraft for existing flight condition (all axes).
 - (2) Rotate heading bug to desired heading. Engage autopilot.
 - (3) During maneuvering flight - control aircraft through use of the HDG bug. (HDG mode)
 - (4) For navigation operations select modes as required by the operation being conducted and in accordance with the mode description provided in the Century 21 Operator's Manual.

SECTION 5 - PERFORMANCE

No changes to the basic performance provided by Section 5 of this Pilot's Operating Handbook are necessary for this supplement.

THIS PAGE INTENTIONALLY LEFT BLANK

SUPPLEMENT 6

PIPER CONTROL WHEEL CLOCK INSTALLATION

SECTION 1 - GENERAL

This supplement supplies information necessary for the operation of the airplane when the optional Piper control wheel clock is installed. The information contained within this supplement is to be used in conjunction with the complete handbook.

This supplement has been "FAA Approved" as a permanent part of this handbook and must remain in this handbook at all times when the optional Piper control wheel clock is installed.

SECTION 2 - LIMITATIONS

No changes of the basic limitations provided by Section 2 of this Pilot's Operating Handbook are necessary for this supplement.

SECTION 3 - EMERGENCY PROCEDURES

No changes of the basic Emergency Procedures provided by Section 3 of this Pilot's Operating Handbook are necessary for this supplement.

SECTION 4 - NORMAL PROCEDURES

(a) **SETTING**

While in the CLOCK mode, the time and the date can be set by the operation of the RST button.

(b) **DATE SETTING**

Pressing the RST button once will cause the date to appear with the month flashing. Pressing the ST-SP button will advance the month at one per second, or at one per push, until the right month appears.

Pressing the RST button once again will cause the date to flash, and it can be set in a similar manner.

(c) TIME SETTING

The RST button must now be pressed two times to cause the hours digits to flash. The correct hour can be set in as described above.

Pressing the RST button once again will now cause the minutes digits to flash. The minutes should be set to the next minute to come up at the zero seconds time mark. The RST button is pressed once more to hold the time displayed. At the time mark, the ST-SP button is pressed momentarily to begin the counting at the exact second.

If the minutes are not advanced when they are flashing in the set mode, pressing the RST button will return the clock to the normal timekeeping mode without altering the minutes timing. This feature is useful when changing time zones, when only the hours are to be changed.

(d) AUTOMATIC DATE ADVANCE

The calendar function will automatically advance the date correctly according to the four year perpetual calendar. One day must be added manually on Feb. 29 on leap year. The date advances correctly at midnight each day.

(e) DISPLAY TEST

Pressing both the RST and ST-SP buttons at the same time will result in a display test function.

SECTION 5 - PERFORMANCE

No changes to the basic performance provided by Section 5 of this Pilot's Operating Handbook are necessary for this supplement.

TABLE OF CONTENTS

SECTION 10

SAFETY TIPS

Paragraph No.	Page No.
10.1 General	10-1
10.3 Safety Tips	10-1

BLANK PAGE

**SECTION 10
SAFETY TIPS**

10.1 GENERAL

This section provides safety tips of particular value in the operation of the Cherokee Warrior II.

10.3 SAFETY TIPS

- (a) Learn to trim for takeoff so that only a very light back pressure on the control wheel is required to lift the airplane off the ground.
- (b) The best speed for takeoff is about 55 KIAS under normal conditions. Trying to pull the airplane off the ground at too low an airspeed decreases the controllability of the airplane in the event of engine failure.
- (c) Flaps may be lowered at airspeeds up to 103 KIAS. To reduce flap operating loads, it is desirable to have the airplane at a slower speed before extending the flaps. The flap step will not support weight if the flaps are in any extended position. The flaps must be placed in the "UP" position before they will lock and support weight on the step.
- (d) Before attempting to reset any circuit breaker, allow a two to five minute cooling off period.
- (e) Before starting the engine, check that all radio switches, light switches and the pitot heat switch are in the off position so as not to create an overloaded condition when the starter is engaged.
- (f) Anti-collision lights should not be operating when flying through cloud, fog or haze, since the reflected light can produce spatial disorientation. Strobe lights should not be used in close proximity to the ground such as during taxiing, takeoff or landing.
- (g) The rudder pedals are suspended from a torque tube which extends across the fuselage. The pilot should become familiar with the proper positioning of his feet on the rudder pedals so as to avoid interference with the torque tube when moving the rudder pedals or operating the toe brakes.
- (h) In an effort to avoid accidents, pilots should obtain and study the safety related information made available in FAA publications such as regulations, advisory circulars, Aviation News, AIM and safety aids.
- (i) Prolonged slips or skids which result in excess of 2000 ft. of altitude loss, or other radical or extreme maneuvers which could cause uncovering of the fuel outlet must be avoided as fuel flow interruption may occur when tank being used is not full.

**SECTION 10
SAFETY TIPS**

**PIPER AIRCRAFT CORPORATION
PA-28-161, CHEROKEE WARRIOR II**

- (j) Hand starting of the engine is not recommended, however, should hand starting of the engine be required, only experienced personnel should attempt this procedure. The magneto selector should be placed to "LEFT" during the starting procedures to reduce the probability of "kick back." Place the ignition switch to "BOTH" position after the engine has started.

Information contained
in this section is not
part of the
Manufacturers Pilot
Operating Handbook

This section is for use
at pilot discretion
only

PREPARED	PIPER AIRCRAFT CORP. DEVELOPMENT CENTER, VERO BEACH, FLA.	REPORT VB-838
CHECKED		MODEL PA-28-161 2 December 1976
APPROVED		PAGE 9

SECTION 4 - PERFORMANCE

4.1 - PERFORMANCE CHARTS

The charts in this Section contain data establishing weight limitations for take-off and landing in accordance with Air Navigation Orders Section 20.7.4.

Extrapolation outside the boundaries of the performance charts is not permitted. When the outside air temperature and/or pressure height is below the lowest range scheduled on the charts, the aeroplane performance shall be assumed to be no better than that appropriate to this lowest range. The performance information is not valid when the outside air temperature and/or pressure height exceed the maximum values for which this information is scheduled.

4.2 - TAKE-OFF

The gross weight of the aeroplane for take-off shall not exceed the lesser of:

- (i) the maximum take-off weight specified in Section 2 of this Manual; and
- (ii) the gross weight for take-off determined from the take-off weight chart of this Section.

The take-off chart is based on factored take-off distances from rest to a height of 50 feet with the engine operating at take-off power. The surface corrections on the chart are based on standard factors related to strips with a firm surface. Soft ground and unusually long and/or wet grass will increase the take-off distance over that scheduled and the pilot should therefore ensure that adequate strip length is available to cover these conditions.

For sealed and gravel surfaces, the gross weight for take-off shall be determined as for a short dry grass surface.

The technique used in establishing the take-off distance is such that the aeroplane is held on or close to the ground until the appropriate take-off safety speed is approached, and the climb away then commenced so that this speed is achieved and maintained at or before the 50 foot height point.

When included on the take-off weight chart, the climb weight limitation graph provides for a weight restriction to ensure that the aeroplane achieves the required 6 percent climb gradient at take off. This graph is based on a climb at the take off safety speed using take off power.

PREPARED	PIPER AIRCRAFT CORP. DEVELOPMENT CENTER, VERO BEACH, FLA.	REPORT VB-838
CHECKED		MODEL PA-28-161
APPROVED		2 December 1976
		PAGE 10

4.3 - Landing

The gross weight of the aeroplane for landing shall not exceed the lesser of: -

- (i) the maximum landing weight specified in Section 2 of this Manual; and
- (ii) the gross weight for landing determined from the landing weight chart of this Section.

The landing weight chart is based on factored landing distances on a short dry grass surface from a height of 50 feet to stop. The chart is also applicable to sealed and gravel strips. Wet and/or slippery surfaces will increase the landing distance over that scheduled and the pilot should therefore ensure that adequate strip length is available to cover these conditions.

The technique used in establishing the landing distance is such that the aeroplane approaches at the given approach speed in a glide through the 50 foot height point at the strip threshold. After touchdown, maximum wheel braking is used to bring the aeroplane to a stop.

When included on the landing weight chart, the climb weight limitation graph provides for a weight restriction to ensure that the aeroplane achieves the required 3.2 percent climb gradient during a baulked landing. This graph is based on a climb after accelerating to 63 KTS IAS and using take-off power.

In determining the gross weight for landing from the landing weight chart of this Section for Night V. M. C. operations, the distance applied to the landing weight chart shall be the actual distance available reduced by 20 percent.

PRER MODEL PA-28-161
TAKE-OFF WEIGHT CHART

2ND NOTCH OF FLAP

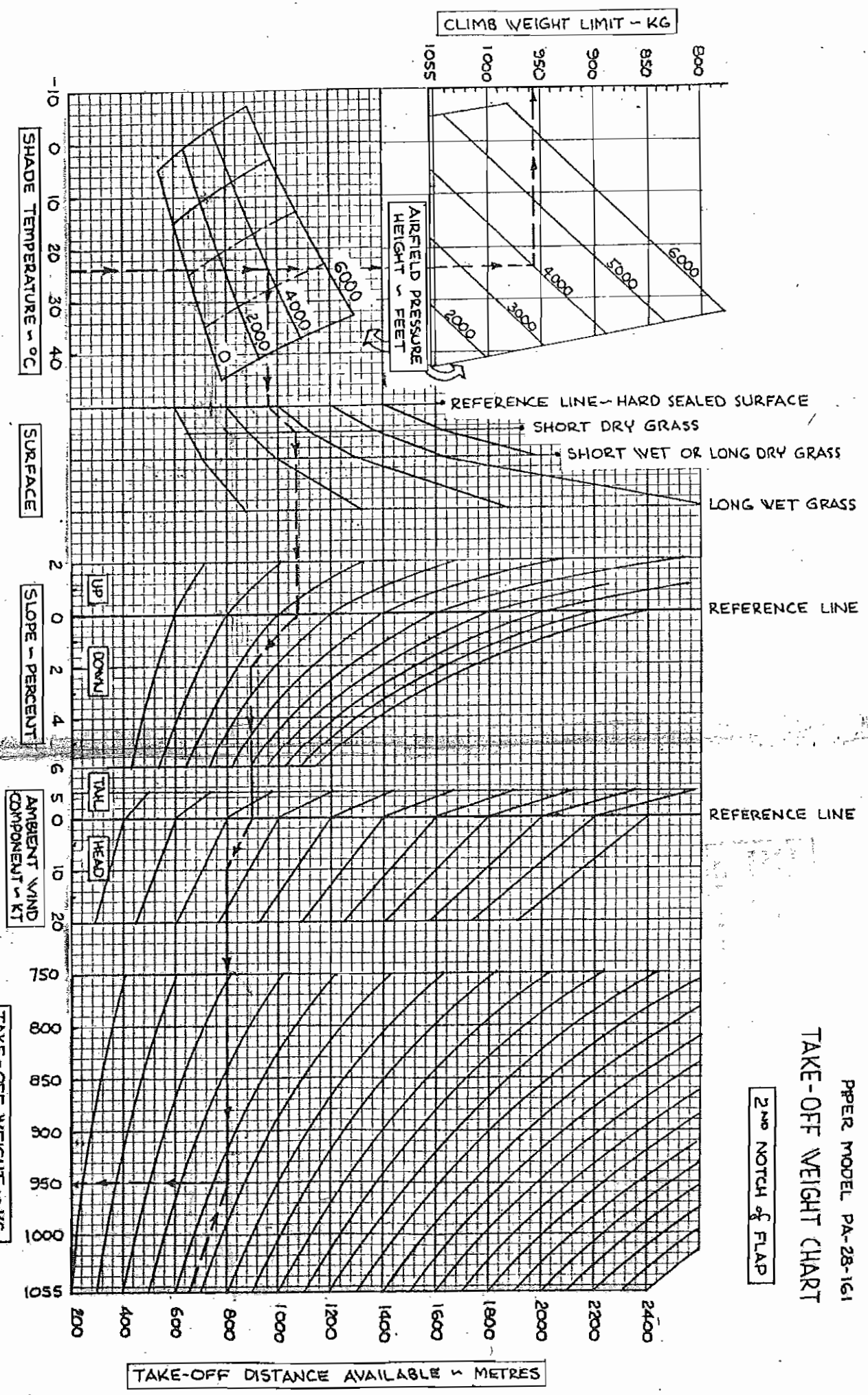

© 1979 by
 B. & G. ASSOCIATES PVT LTD.
 -087-02 / ISSUE 1 / 19-1-79 / JB

FLAP SETTINGS - 2ND NOTCH
 TAKE-OFF SAFETY SPEED 58 KI/AS
 POWER SETTINGS - FULL THROTTLE
 CHART DISTANCE FACTOR 1.15

NOTE: TAKE-OFF WEIGHT MUST NOT EXCEED CLIMB WEIGHT LIMIT AT...

TAKE-OFF WEIGHT CHART

ZERO FLAP

REFERENCE LINE

REFERENCE LINE

LONG WET GRASS
SHORT WET OR LONG DRY GRASS
SHORT DRY GRASS
REFERENCE LINE - HARD SEALED SURFACE

CLIMB WEIGHT LIMIT - KG

1055
950
900
850

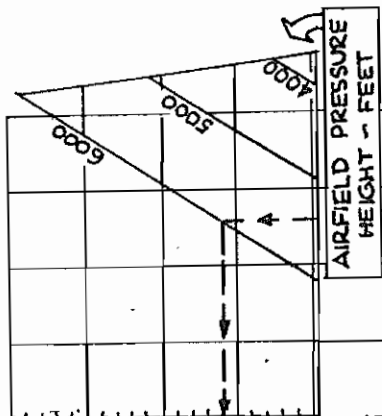

SHADE TEMPERATURE - °C

-10 0 10 20 30 40

SURFACE

SLOPE - PERCENT

AMBIENT WIND COMPONENT - KT

TAKE-OFF WEIGHT - KG

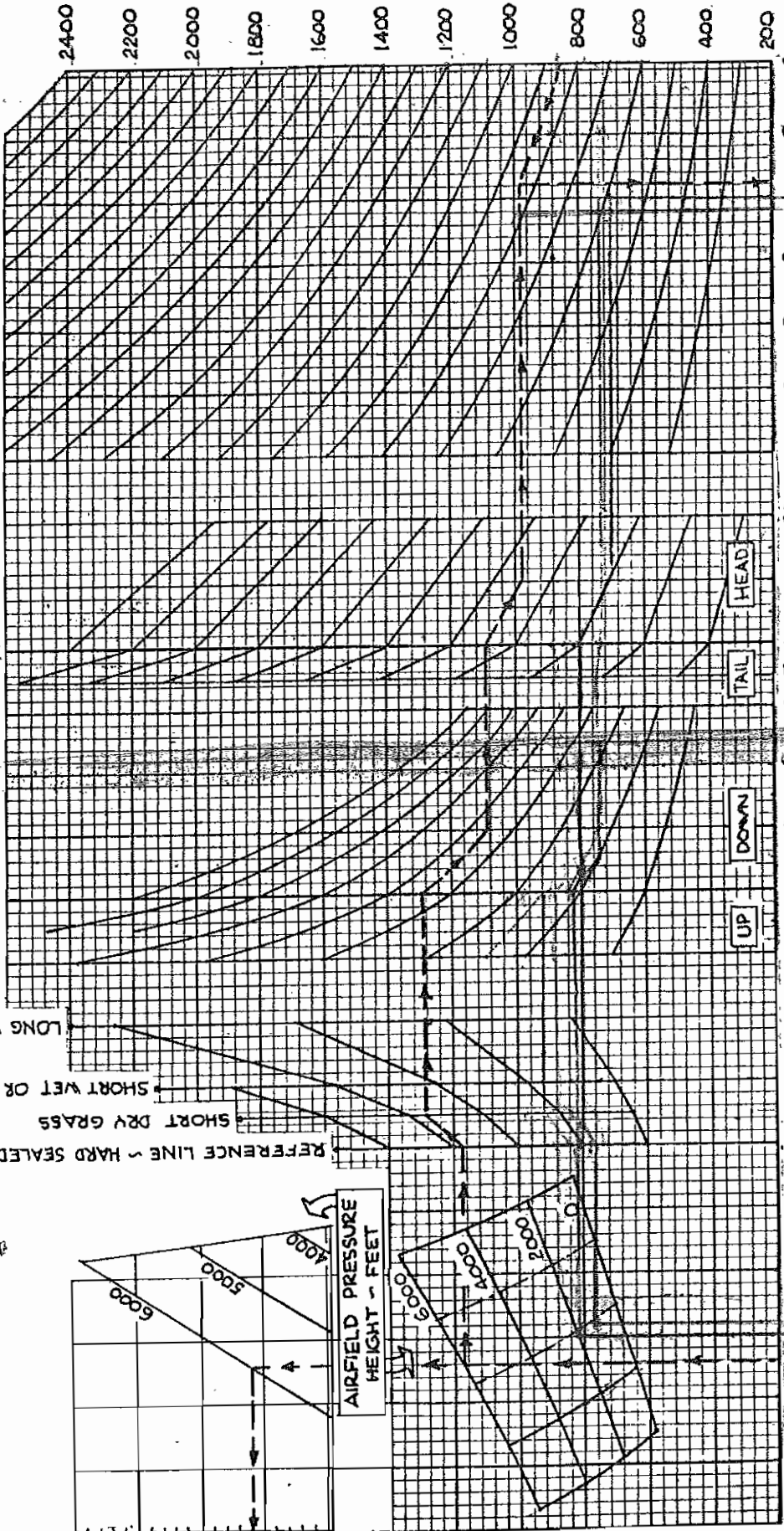

NOTE: TAKE-OFF WEIGHT MUST NOT EXCEED CLIMB WEIGHT LIMIT ABOVE

FLAP SETTING - ZERO
TAKE-OFF SAFETY SPEED 64 KT IAS
POWER SETTING - FULL THROTTLE
RPM - NOT LESS THAN 2350
CHART DISTANCE FACTOR 1.15

© 1979 by
B. & G. ASSOCIATES PTY LTD
AV-087-01 / ISSUE 1 / 18-1-79 / JB

LANDING DISTANCE CHART

CLIMB WEIGHT LIMIT ~ KG



AIRFIELD PRESSURE HEIGHT ~ FEET

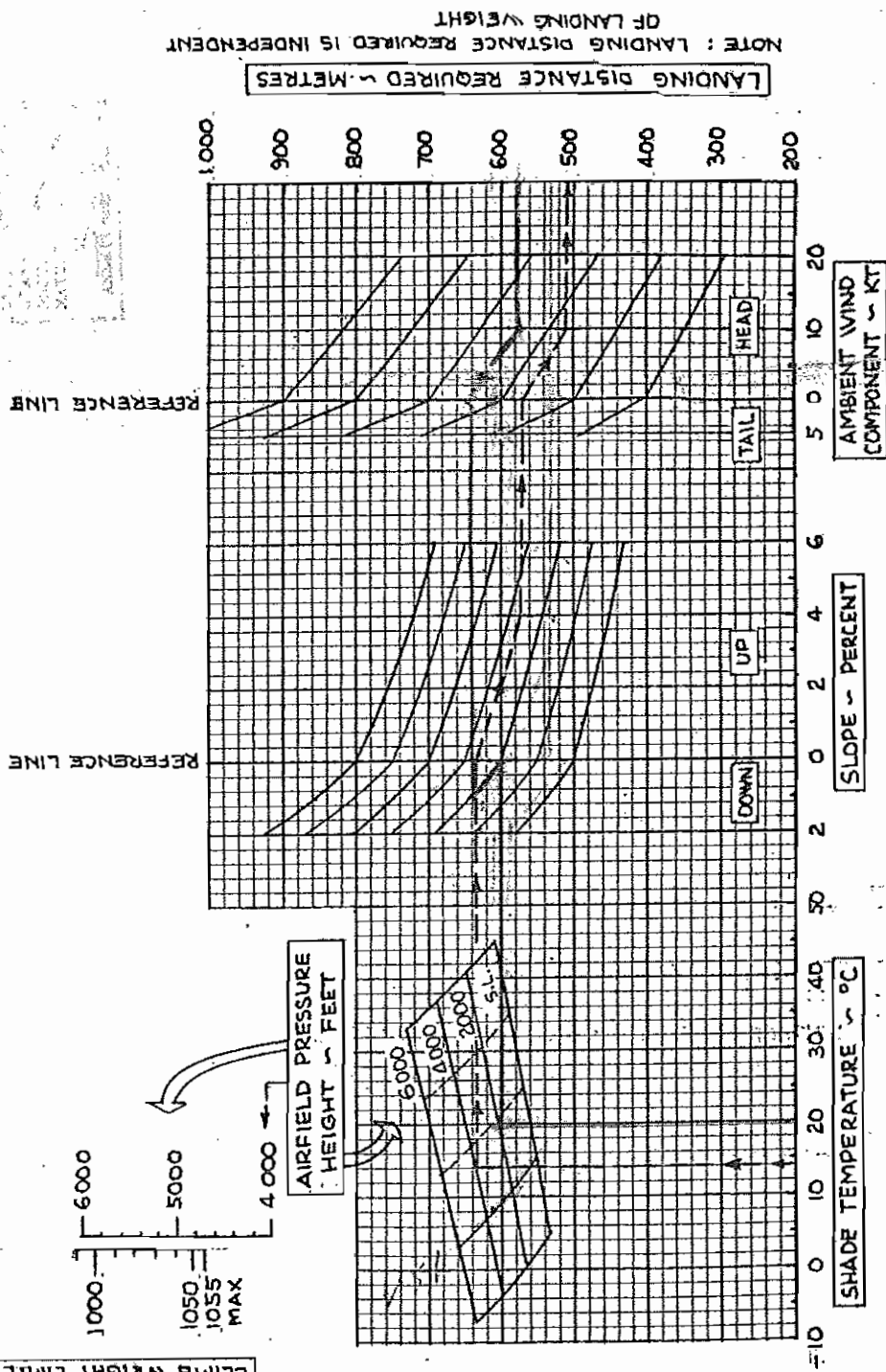
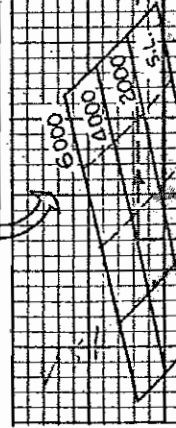

FLAP SETTING 40°
 APPROACH SPEED 65 KT IAS
 LANDING DISTANCE FACTOR 1.15

NOTE:
 LANDING WEIGHT MUST NOT EXCEED CLIMB WEIGHT LIMIT ABOVE.

© 1978 by
 B. & G. ASSOCIATES PTY. LTD.

AV-079-02/ISSUE 1 / 13-11-78 / J.B.

2/m

PROPOSED	PIPER AIRCRAFT CORP. DEVELOPMENT CENTER, VERO BEACH, FLA.	REPORT VB-838
CHECKED		MODEL PA-28-161
APPROVED		2 December 1976
		PAGE _____

6.2 - Aeroplane Weight

Aeroplane Type : PIPER PA-28-161 'Cherokee Warrior II'.

Registration Marking VH- DDX (Aircraft s/no.: 28-7816137)

Issue	Date	Date of Expiry
2	23/5/78	INDEFINITE.

Aeroplane Weight and Centre of Gravity Data:

<u>EMPTY/BASIC EMPTY Weight (Kg)</u> (see note below)	Arm (millimeters) Aft of the Datum	MOMENT/1000 Index Units	Cabin Configuration
<u>EMPTY WEIGHT.</u> 659.2	2213.8	1459.35	4 SEATS TOTAL.
<u>BASIC EMPTY WEIGHT.</u> 666.2	2197.7	1464.11	4 SEATS TOTAL.

Note: The above weight(s) include UNUSABLE FUEL (7.6 litres),
UNDRAINABLE OIL, & 'FIXED EQUIPMENT' AS PER PIPER PILOT'S OPERATING
HANDBOOK FOR AIRCRAFT S/NO: 28-7816137 PAGES 6-17 to 6-55. WITH PAGES
6-54 AMENDED ON 8/3/78 AND 6-44 AMENDED ON 8/3/78 & 23/5/78.

NOTE:..... 'BASIC EMPTY WEIGHT' = 'EMPTY WEIGHT' + FULL OIL (15.0 kg).

APPROVED:.....

S. C. Rigby 23/5/78

S. C. RIGBY, 33 CRAYFORD CRES, MT. PRITCHARD 2170
D.O.T.

AUTHORITY AN11

4/12

PREPARED	PIPER AIRCRAFT CORP. DEVELOPMENT CENTER, VERO BEACH, FLA.	REPORT VB-838
CHECKED		MODEL PA-28-161
APPROVED		2 December 1976
		PAGE _____

6.2 - Aeroplane Weight

Aeroplane Type :... PIPER PA-28-161 'CHEROKEE WARRIOR II'.

Registration Marking VH- DDK (Aircraft s/no:.. 28-7816422)

Issue	Date	Date of Expiry
1	23/5/78	INDEFINITE.

Aeroplane Weight and Centre of Gravity Data:

EMPTY/BASIC EMPTY Weight (Kg) (see note below)	Arm (millimeters) Aft of the Datum	(MOMENT/1000) Index Units	Cabin Configuration
<u>EMPTY WEIGHT.</u> 659.9	2215.5	1462.04	4 SEATS TOTAL.
<u>BASIC EMPTY WEIGHT</u> 666.7	2200.1	1466.79	4 SEATS TOTAL.
1473.40 LBS.	86.62 INS	127630 IN/LBS	

Note: The above weight(s) include UNUSABLE FUEL (7.6 litres),
UNDRAINABLE OIL & 'FIXED EQUIPMENT' AS PER PIPER PILOT'S OPERATING
HANDBOOK FOR AIRCRAFT S/NO: 28-7816422 PAGES 6-17 to 6-55 (as amended
on date 23/5/78).

NOTE:... 'BASIC EMPTY WEIGHT' = 'EMPTY WEIGHT' + FULL OIL (15.0 kg).

APPROVED:.....

S. C. Rigby
23/5/78

S. C. RIGBY, 33 CRAYFORD GRES, MT. PRITCHARD 2170
D.O.T. AIRCRAFT WEIGHT CONTROL AUTHORITY AN11
PH. SYDNEY 607 9214

Approval
Stamp

FLIGHT MAN' -
SECTION 6. - LOADING SYSTEM.

AIRCRAFT TYPE:...PIPER PA-28-161
REGISTRATION MARKING:...: VH-DDX
AIRCRAFT SERIAL NO:... 28-7816137

ISSUE NO.	DATE
2	23/5/78

The Gross Weight & C.G.Limitations approved in this Flight Manual for the above aircraft will not be exceeded at take-off, landing or in-flight if the following simple rules are observed:...

NORMAL CATEGORY

1. OCCUPANTS: Load front seat before rear seats.
** Heaviest pax. must sit in front seat.
2. BAGGAGE (REAR CABIN):

NO. OF OCCUPANTS	MAXIMUM BAGGAGE
1 (pilot)	90 kg
2	90 kg
* 3	82 kg
* 4	45 kg

Note- If children are carried in row 2 seats, then baggage may be carried up to 90 kg maximum in cases marked * , provided that total weight of row 2 seat occupants and rear baggage does not exceed 150 kg.

3. FUEL: Load as required for flight , provided that Max. Take-Off Weight of 1054 kg is not exceeded. (Empty Weight of above aircraft plus engine oil is 666.2 kg.).

UTILITY CATEGORY

1. OCCUPANTS: Load front seats only.
2. BAGGAGE: Nil permitted.
3. FUEL: a) Pilot only operations -
max. fuel = 70 litres.
b) Pilot + pax. operations -
if total pilot + pax. weight does not exceed 130 kg, max. fuel = 120 litres.

If total pilot + pax. weight exceeds 130 kg,
max. fuel is restricted only by Max.
Take-Off Weight of 884 kg.

** If it is not practicable for heaviest pax. to be seated in front row seat, then the heaviest pax. may sit in row 2 provided that total row 2 pax. weight does not exceed 154 kg.

APPROVED:...

S. C. Rigby
23/5/78

S. C. RIGBY, 33 CRAYFORD CRES, MT. PRITCHARD 2170
D.O.T. AIRCRAFT WEIGHT CONTROL AUTHORITY AN11
PH. SYDNEY 607 9214

PA28 - 161

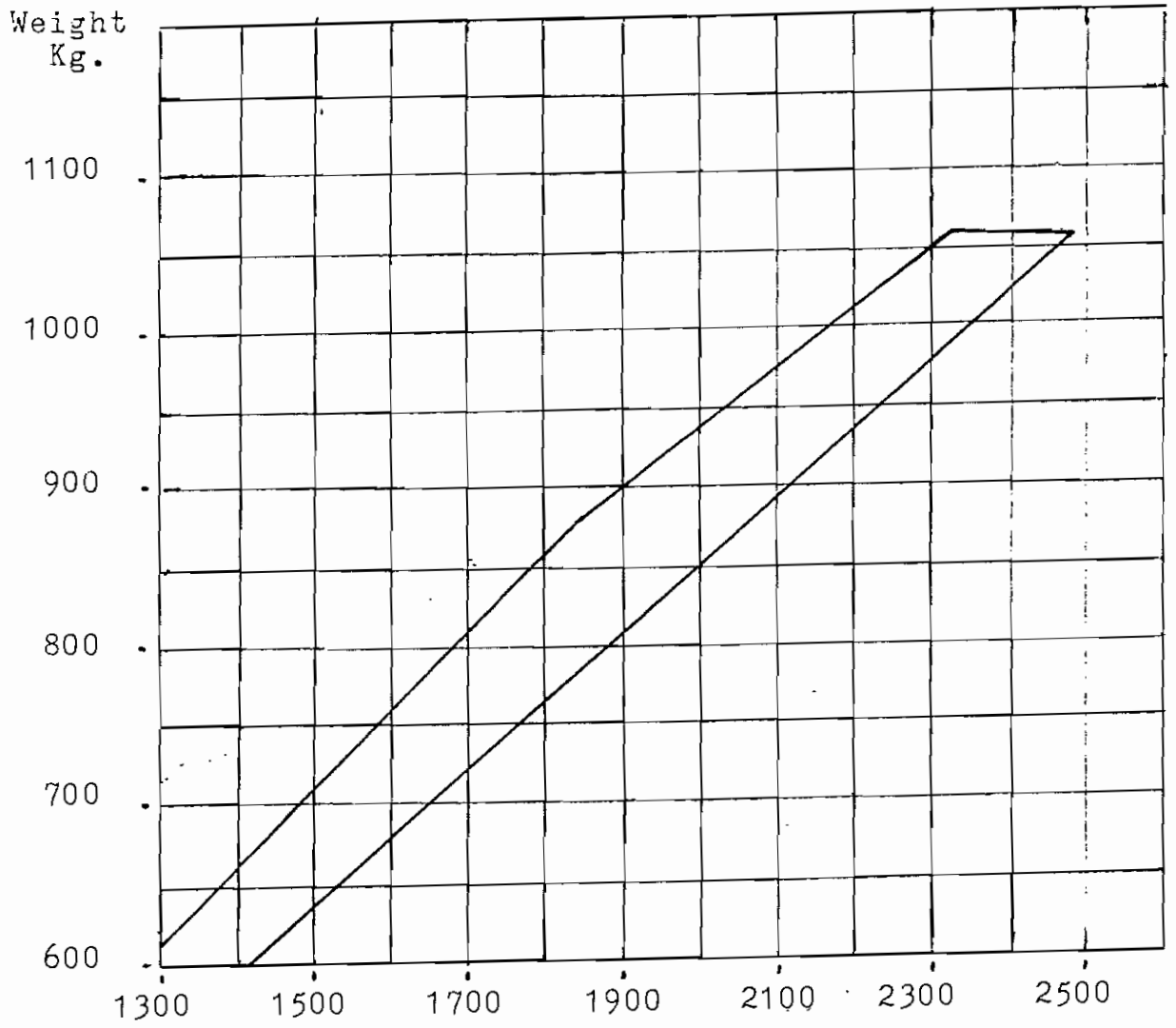

Moment Kg/mm x 1000
C of G Moment Envelope

FLIGHT NO:	DATE:
FROM:	TO:
CAPTAIN:	
FIRST OFFICER:	

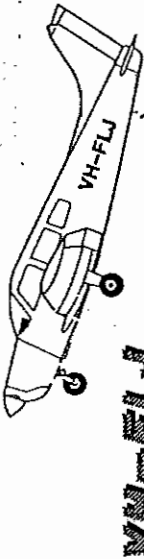

PIPER PA28-161 LOAD SYSTEM JL-198 ISSUE 2

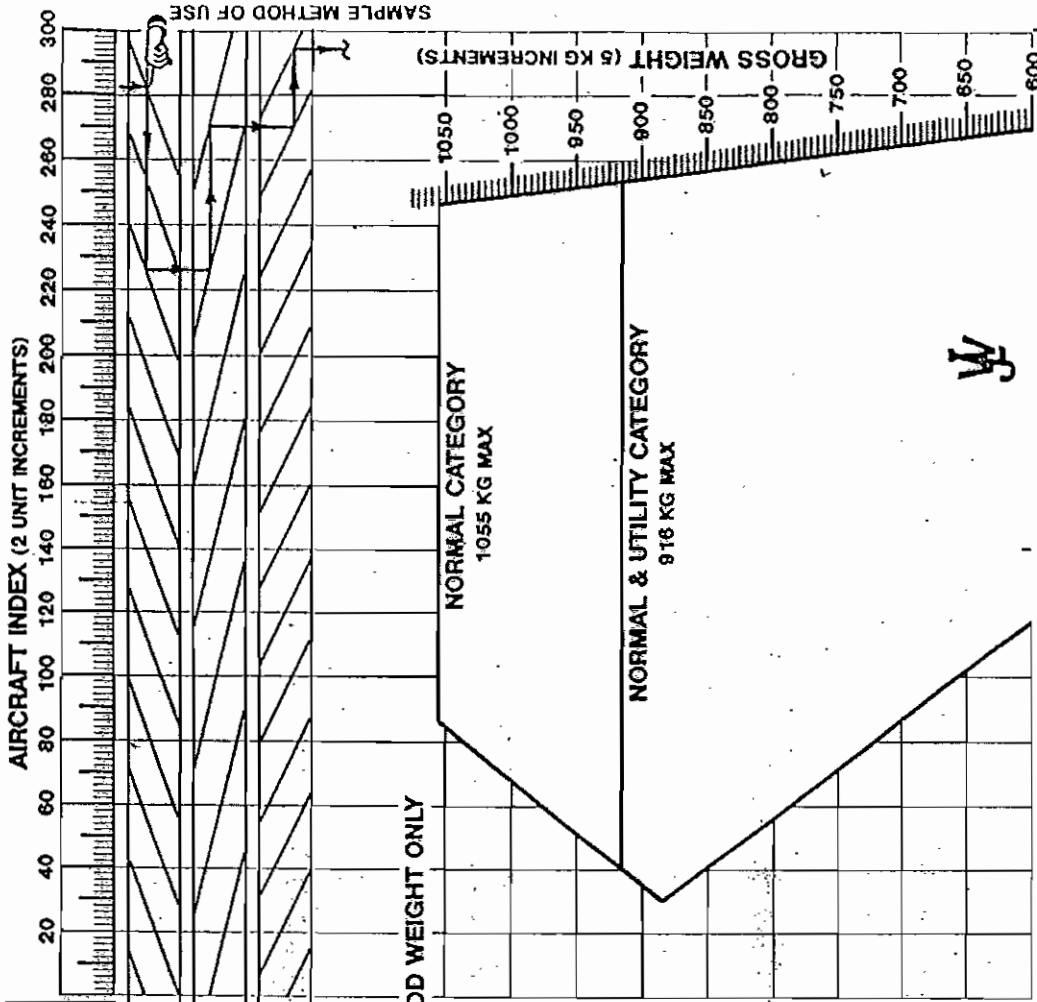

	WEIGHT KG	INDEX
A/C BASIC WEIGHT		
SEATS - FWD		77 KG
- REAR		77 KG
BAGGAGE		20 KG
ZERO FUEL WEIGHT		
FUEL		
TAKE OFF WEIGHT		

NIL SCALE - ADD WEIGHT ONLY

METHOD OF USE

(SEE SAMPLE ON RM MARGIN)

- OBTAIN THE AIRCRAFT BASIC INDEX AND DROP A VERTICAL LINE TO THE INDEX SCALE IN USE. MOVE HORIZONTALLY ALONG THIS SCALE IN THE INDICATED DIRECTION FOR THE APPROPRIATE LOAD INCREMENT, BEFORE MOVING VERTICALLY UP OR DOWN TO THE OTHER SCALES IN USE, MOVING ALONG EACH SCALE IN THE SAME MANNER.
- DRAW A VERTICAL LINE FROM THE LAST COMPARTMENT SCALE IN USE DOWN TO THE C of G ENVELOPE (NEGLECTING THE FUEL SCALE), STOPPING AT THE APPROPRIATE WEIGHT. THIS POINT SHOWS THE C of G AT ZERO FUEL WEIGHT.
- THE C of G AT TAKE-OFF WEIGHT IS FOUND BY ADDING THE FUEL WEIGHT AND DRAWING A LINE ACROSS FROM THE GROSS WEIGHT TO THE VERTICAL LINE PREVIOUSLY DRAWN FROM THE ZERO FUEL WEIGHT.

COPYRIGHT © 1993
J.W. LIDDLE
6 PERINGA ST
COOPERS PLAINS
QLD. 4108
PHONE: (07) 2771311.
OR (07) 2773621

CERTIFICATION

I AM SATISFIED THAT THE AIRCRAFT IS CORRECTLY LOADED FOR SAFETY IN ACCORDANCE WITH REGULATIONS SPECIFIED BY C.A.A.

CAPTAIN/COPILOT/APPROVED
LOAD CONTROLLER:
DELETE AS NECESSARY

DATE TIME

WJ

W(A-2413)/1000 P300

THE OWNER/OPERATOR OF VH-FLJ IS HEREBY AUTHORISED TO REPRODUCE LOAD SYSTEM JL-198 ISSUE 2 PROVIDED THAT IT IS REPRODUCED WITHOUT ANY ALTERATIONS WHATSOEVER AND IS NOT USED FOR ANY OTHER AIRCRAFT.
THE COPYRIGHT REMAINS THE PROPERTY OF J.W. LIDDLE
APPROVED: 21/8/93

