

# ARROW

## PA-28R-201

SN 2844001 AND UP

### PILOT'S OPERATING HANDBOOK

AND

### FAA APPROVED AIRPLANE FLIGHT MANUAL

AIRPLANE  
SERIAL NO. \_\_\_\_\_

AIRPLANE  
REGIST. NO. HB-PQX

PA-28R-201

REPORT: VB-1612 FAA APPROVED BY:



PETER E. PECK

D.O.A. NO. SO-1

THE NEW PIPER AIRCRAFT, INC.

VERO BEACH, FLORIDA

DATE OF APPROVAL:

JULY 12, 1995

THIS HANDBOOK INCLUDES THE MATERIAL REQUIRED TO BE FURNISHED TO THE PILOT BY THE FEDERAL AVIATION REGULATIONS AND ADDITIONAL INFORMATION PROVIDED BY THE MANUFACTURER AND CONSTITUTES THE FAA APPROVED AIRPLANE FLIGHT MANUAL. THIS HANDBOOK MUST BE CARRIED IN THE AIRPLANE AT ALL TIMES.



**Piper**<sup>TM</sup>

***WARNING***

EXTREME CARE MUST BE EXERCISED TO LIMIT THE USE OF THIS HANDBOOK TO APPLICABLE AIRCRAFT. THIS HANDBOOK REVISED AS INDICATED BELOW OR SUBSEQUENTLY REVISED IS VALID FOR USE WITH THE AIRPLANE IDENTIFIED ON THE FACE OF THE TITLE PAGE. SUBSEQUENT REVISIONS SUPPLIED BY PIPER MUST BE PROPERLY INSERTED.

Published by  
PUBLICATIONS DEPARTMENT

Issued: July 12, 1995

© 1995-1996, 1998, 2000-2001, 2004-2006, 2009-2011

THE NEW PIPER AIRCRAFT, INC.

All Rights Reserved

**REPORT: VB-1612**

**ii**

**ISSUED: JULY 12, 1995**  
**REVISED: OCTOBER 24, 2011**

## **APPLICABILITY**

Application of this handbook is limited to the specific Piper PA-28R-201 model airplane designated by serial number and registration number on the face of the title page of this handbook.

This handbook cannot be used for operational purposes unless kept in a current status.

## **WARNING**

**INSPECTION, MAINTENANCE AND PARTS REQUIREMENTS FOR ALL NON-PIPER APPROVED STC INSTALLATIONS ARE NOT INCLUDED IN THIS HANDBOOK. WHEN A NON-PIPER APPROVED STC INSTALLATION IS INCORPORATED ON THE AIRPLANE, THOSE PORTIONS OF THE AIRPLANE AFFECTED BY THE INSTALLATION MUST BE INSPECTED IN ACCORDANCE WITH THE INSPECTION PROGRAM PUBLISHED BY THE OWNER OF THE STC. SINCE NON-PIPER APPROVED STC INSTALLATIONS MAY CHANGE SYSTEMS INTERFACE, OPERATING CHARACTERISTICS AND COMPONENT LOADS OR STRESSES ON ADJACENT STRUCTURES, PIPER PROVIDED INSPECTION CRITERIA MAY NOT BE VALID FOR AIRPLANES WITH NON-PIPER APPROVED STC INSTALLATIONS.**

## REVISIONS

The information compiled in the Pilot's Operating Handbook, with the exception of the equipment list, will be kept current by revisions distributed to the airplane owners. The equipment list was current at the time the airplane was licensed by the manufacturer and thereafter must be maintained by the owner.

Revision material will consist of information necessary to update the text of the present handbook and/or to add information to cover added airplane equipment.

### I. Revisions

Revisions will be distributed whenever necessary as complete page replacements or additions and shall be inserted into the handbook in accordance with the instructions given below:

1. Revision pages will replace only pages with the same page number.
2. Insert all additional pages in proper numerical order within each section.
3. Insert page numbers followed by a small letter in direct sequence with the same common numbered page.

### II. Identification of Revised Material

Each handbook page is dated at the bottom of the page showing the date of original issue and the date of the latest revision. Revised text and illustrations are indicated by a black vertical line located along the outside margin of each revised page opposite the revised, added, or deleted information. A black vertical line next to the page number indicates that an entire page has been changed or added.

Black vertical lines indicate current revisions only. Correction of typographical or grammatical errors or the physical relocation of information on a page will not be indicated by a symbol.

## ORIGINAL PAGES ISSUED

The original pages issued for this handbook prior to revision are given below:

Title, ii through viii, 1-1 through 1-12, 2-1 through 2-10, 3-1 through 3-20, 4-1 through 4-28, 5-1 through 5-34, 6-1 through 6-12, 7-1 through 7-32, 8-1 through 8-18, 9-1 through 9-12, 10-1 through 10-2.

**REPORT: VB-1612**



**iv**

**ISSUED: JULY 12, 1995**

**REVISED: JANUARY 5, 2004**

**PILOT'S OPERATING HANDBOOK LOG OF REVISIONS**

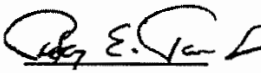
Current Revisions to the PA-28R-201 Arrow Pilot's Operating Handbook,  
 REPORT: VB-1612 issued July 12, 1995.

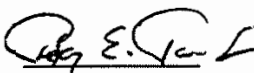
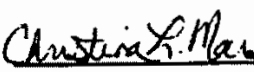
| Revision Number and Code | Revised Pages                            | Description of Revisions   | FAA Approved Signature and Date  |
|--------------------------|--|--|--|
| Rev. 1<br>(PR951211)     | v<br>9-i<br>9-13<br>thru<br>9-24         | Added Rev. 1 to L of R page.<br>Revised Table of Contents.<br>Added Supplement 4<br>KLN 89B GPS.   | <br>Peter E. Peck<br><br><u>Dec. 11, 1995</u><br>Date        |
| Rev. 2<br>(PR960830)     | v<br>7-32                                | Added Rev. 2 to L of R page.<br>Added ELT info.  | <br>Peter E. Peck<br><br><u>Aug. 30, 1996</u><br>Date        |
| Rev. 3<br>(PR981116)     | v<br>2-10<br>9-i<br>9-25<br>thru<br>9-36 | Added Rev. 3 to L of R page.<br>Revised para. 2.23.<br>Revised T of C.<br>Added Supplement 5 -<br>Bendix/King KX-155A<br>Comm/Nav System | <br>Peter E. Peck<br><br><u>Nov. 16, 1998</u><br>Date      |
| Rev. 4<br>(PR000131)     | v<br>9-i<br>9-37<br>thru<br>9-38         | Added Rev. 4 to L of R page.<br>Revised T of C.<br>Added pages<br>and Supplement 6.  | <br>Christina L. Marsh<br><br><u>Jan. 31, 2000</u><br>Date |
| Rev. 5<br>(PR000914)     | v, vi<br>9-i<br>9-39<br>thru<br>9-46     | Added Rev. 5 to L of R page.<br>Revised T of C.<br>Added pages<br>and Supplement 7.  |  |

**ISSUED: JULY 12, 1995**

**REVISED: SEPTEMBER 14, 2000**

**REPORT: VB-1612**

v

## PILOT'S OPERATING HANDBOOK LOG OF REVISIONS (cont)

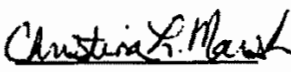
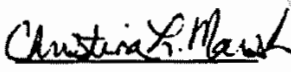
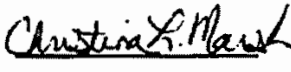
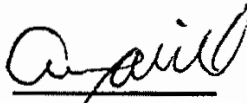
| Revision Number and Code          | Revised Pages  | Description of Revisions  | FAA Approved Signature and Date  |
|-----------------------------------|--|---|--|
| Rev. 5<br>(PR000914)<br>continued | 9-47<br>thru<br>9-56<br>9-57<br>thru<br>9-62<br>9-63<br>thru<br>9-68<br>9-69<br>thru<br>9-72<br>9-73<br>thru<br>9-74 | Added pages<br>and Supplement 8.<br><br>Added pages<br>and Supplement 9.<br><br>Added pages<br>and Supplement 10.<br><br>Added pages<br>and Supplement 11.<br><br>Added pages<br>and Supplement 12. | <br>Christina L. Marsh<br><br><u>Sep. 14, 2000</u><br>Date   |
| Rev. 6<br>(PR001221)              | vi<br>9-i<br>9-75<br>thru<br>9-76  | Added Rev. 6 to L of R page.<br>Revised T of C.<br>Added pages<br>and Supplement 13.  | <br>Christina L. Marsh<br><br><u>Dec. 21, 2000</u><br>Date |
| Rev. 7<br>(PR010129)              | vi<br>2-7  | Added Rev. 7 to L of R page.<br>Revised para. 2.23.   | <br>Christina L. Marsh<br><br><u>Jan. 29, 2001</u><br>Date |
| Rev. 8<br>(PR011220)              | vi<br>9-i<br>9-77<br>thru<br>9-86  | Added Rev. 8 to L of R page.<br>Revised T of C.<br>Added pages<br>and Supplement 14.  | <br>Albert J. Mill<br><br><u>Dec. 20, 2001</u><br>Date     |

REPORT: VB-1612

vi

ISSUED: JULY 12, 1995

REVISED: DECEMBER 20, 2001



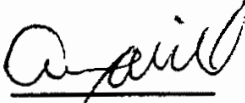
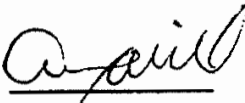

## PILOT'S OPERATING HANDBOOK LOG OF REVISIONS (cont)

| Revision Number and Code | Revised Pages         | Description of Revisions                           | FAA Approval Signature and Date   |
|--------------------------|-----------------------|--|---|
| Rev. 9<br>(PR040105)     | iii                   | Added Warning and moved info. to page iv.          | <br>Albert J. Mill<br><br><u>Jan. 5, 2004</u><br>Date     |
|                          | iv                    | Moved info. from page iii.                         |   |
|                          | vi-a                  | Added page and Rev. 9 to L of R.                   |   |
|                          | vi-b                  | Added page.  |   |
|                          | 2-7                   | Revised para. 2.23.                                |   |
|                          | 2-8                   | Revised para. 2.23.                                |   |
|                          | 8-1                   | Moved info. to page 8-1b and revised para. 8.1.    |   |
|                          | 8-1a                  | Added page and revised para. 8.1.                  |   |
|                          | 8-1b                  | Added page and moved info. from pages 8-1 and 8-2. |   |
|                          | 8-2                   | Moved info. to page 8-1b and revised para. 8.3.    |   |
|                          | 9-i                   | Revised T of C.                                    |   |
|                          | 9-40                  | Revised Section 1.                                 |   |
|                          | 9-87<br>thru<br>9-90  | Added pages and Supplement 15.                     |   |
| Rev. 10<br>(PR040310)    | vi-a                  | Added Rev. 10 to L of R.                           | <br>Albert J. Mill<br><br><u>March 10, 2004</u><br>Date |
|                          | 3-3                   | Revised para. 3.5b.                                |   |
|                          | 3-5                   | Revised para. 3.5e.                                |   |
|                          | 4-4                   | Revised para. 4.5a.                                |   |
|                          | 4-5                   | Revised para. 4.5a.                                |   |
| Rev. 11<br>(PR041007)    | vi-a                  | Added Rev. 11 to L of R.                           |   |
|                          | vi-b                  | Added Rev. 11 to L of R.                           |   |
|                          | 7-21                  | Revised Figure 7-21.                               |   |
|                          | 9-i                   | Revised T of C.                                    |   |
|                          | 9-91<br>thru<br>9-108 | Added pages and Supplement 16.                     |   |

ISSUED: JULY 12, 1995  
 REVISED: OCTOBER 7, 2004

REPORT: VB-1612  
 vi-a

## PILOT'S OPERATING HANDBOOK LOG OF REVISIONS (cont)

| Revision Number and Code           | Revised Pages  | Description of Revisions  | FAA Approval Signature and Date   |
|------------------------------------|--|---|---|
| Rev. 11<br>(PR041007)<br>continued | 9-109<br>thru<br>9-112   | Added pages<br>and Supplement 17.   | <br>Linda J. Dicken<br>October 7, 2004  |
| Rev. 12<br>(PR050117)              | vi-b<br>2-7<br>thru<br>2-10<br>9-96<br>9-98<br>9-100<br>9-108  | Added Rev. 12 to L of R.<br>Revised and reorganized<br>para. 2.23 Placards.<br><br>Revised Section 3.<br>Revised Section 3.<br>Revised Section 3.<br>Revised Section 7. | <br>Linda J. Dicken<br>Jan. 17, 2005    |
| Rev. 13<br>(PR050523)              | vi-b<br>9-i<br>9-91<br>thru<br>9-118<br>9-119<br>thru<br>9-122 | Added Rev. 13 to L of R.<br>Revised T of C.<br>Revised Supplement 16.<br><br>Revised page numbers.  | <br>Linda J. Dicken<br>May 23, 2005   |
| Rev. 14<br>(PR050912)              | vi-b<br>2-5<br>9-94<br>9-95                                    | Added Rev. 14 to L of R.<br>Revised para. 2.15.<br>Moved info. from page 9-95.<br>Moved info. to page 9-94 and<br>revised Section 2.                                    | <br>Linda J. Dicken<br>Sept. 12, 2005 |
| Rev. 15<br>(PR051128)              | vi-b<br>9-96<br>9-99<br>9-101<br>9-103<br>9-104                | Added Rev. 15 to L of R.<br>Revised Section 3.<br>Revised Section 3.<br>Revised Section 3.<br>Revised Section 3.<br>Revised Section 3.                                  | <br>Linda J. Dicken<br>Nov. 28, 2005  |

REPORT: VB-1612

vi-b

ISSUED: JULY 12, 1995

REVISED: NOVEMBER 28, 2005

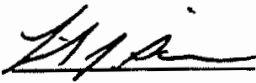
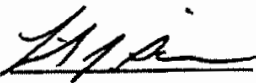
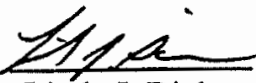
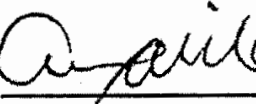
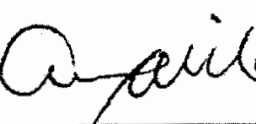
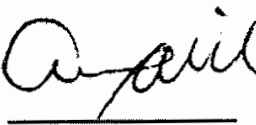

## PILOT'S OPERATING HANDBOOK LOG OF REVISIONS (cont)

| Revision Number and Code | Revised Pages                                | Description of Revisions   | FAA Approval Signature and Date   |
|--------------------------|--|--|---|
| Rev. 16<br>(PR060109)    | vi-c<br>vi-d<br>9-i<br>9-91<br>thru<br>9-118 | Added page and Rev. 16 to L of R.<br>Added page.<br>Revised T of C.<br>Revised Supplement 16.                                  | <br>Linda J. Dicken<br>Jan. 9, 2006       |
| Rev. 17<br>(PR060411)    | vi-c<br>9-111                                | Added Rev. 17 to L of R.<br>Revised Section 7A.  | <br>Linda J. Dicken<br>April 11, 2006     |
| Rev. 18<br>(PR060522)    | vi-c<br>9-i<br>9-123<br>thru<br>9-158        | Added Rev. 18 to L of R.<br>Revised T of C.<br>Added pages and Supplement 18.  | <br>Linda J. Dicken<br>May 22, 2006       |
| Rev. 19<br>(PR090121)    | vi-c<br>9-ii<br>9-159<br>thru<br>9-172       | Added Rev 19 to L of R.<br>Added Supplements 19 and 20 to T of C.<br>Added Supplements 19 and 20.                              | <br>Albert J Mill<br>January 21, 2009   |
| Rev. 20<br>(PR090510)    | vi-c<br>9-92<br>9-124                        | Added Rev. 20 to L of R.<br>Revised wording in Para. Section 1 of Supp. 16.<br>Revised wording in Para. Section 1 of Supp. 18. | <br>Albert J Mill<br>May 10, 2009       |
| Rev. 21<br>(PR090930)    | vi-c<br>4-20<br>8-1b                         | Added Rev. 21 to L of R.<br>Revised Para. 4.13d<br>Revised wording in General Section.   | <br>Albert J Mill<br>September 30, 2009 |

ISSUED: JULY 12, 1995

REVISED: SEPTEMBER 30, 2009

REPORT: VB-1612

vi-c

## PILOT'S OPERATING HANDBOOK LOG OF REVISIONS (cont)

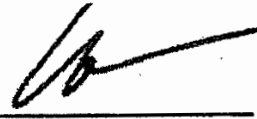
| Revision Number and Code | Revised Pages  | Description of Revisions   | FAA Approval Signature and Date  |
|--------------------------|--|--|--|
| Rev. 22<br>(PR100512)    | vi-d<br>2-8<br>4-i<br>4-ii<br>4-iii<br>4-iv<br>4-7<br>4-8<br>4-9<br>4-10<br>4-11<br>4-12<br>4-13<br>4-18<br>4-18a<br>4-18b<br>4-20<br>7-29<br>7-32<br>9-ii<br>9-107<br>9-144<br>9-173<br>thru<br>9-184 | Added Rev. 22 to L of R<br>Added Note to Para. 2.23<br>Revised TOC. Relocated text to pg. 4-ii.<br>Added text from pg. 4-i.<br>Revised TOC. Relocated text to pg. 4-iii.<br>Added text from pg. 4-ii.<br>Revised TOC.<br>Relocated text to pg. 4-iv.<br>Added text from pg. 4-iii.<br>Revised Para. 4.5c. Relocated text to pg. 4-8.<br>Added text from pg. 4-7.<br>Relocated text to pg. 4-9.<br>Added text from pg. 4-8.<br>Relocated text to pg. 4-10.<br>Added text from pg. 4-9.<br>Relocated text to pg. 4-11.<br>Added text from pg. 4-10.<br>Relocated text to pg. 4-12.<br>Added text from pg. 4-11.<br>Relocated text to pg. 4-13.<br>Added text from pg. 4-12.<br>Moved text to pg. 4-18a.<br>Added Page<br>Added Page.<br>Revised Para. 4.13d.<br>Revised Para. 7.39.<br>Revised Para. 7.39.<br>Added Supplement 21 to T of C.<br>Revised Note in Section 4.<br>Revised Note in Section 4.<br>Added Supplement 21. | <br>Wayne E. Gaulzetti<br>May 12, 2010 |



REPORT: VB-1612

vi-d

ISSUED: JULY 12, 1995

REVISED: MAY 12, 2010

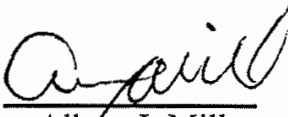
PILOT'S OPERATING HANDBOOK LOG OF REVISIONS (cont)

| Revision Number and Code | Revised Pages                            | Description of Revisions   | FAA Approved Signature and Date  |
|--------------------------|--|--|--|
| Rev. 23<br>(PR101101)    | ii<br>vi-e<br><br>vi-f<br>9-181          | Updated copyright dates.<br>Added Page. Added Rev. 23 to L of R.<br>Added Page.<br>Revised Section 4.                        | <br>Albert J. Mill<br>November 1, 2010     |
| Rev. 24<br>(PR111024)    | ii<br>vi-e<br>9-ii<br>9-185<br><br>9-186 | Updated copyright date.<br>Added Rev. 24 to L of R.<br>Revised T of C.<br>Added page.<br>Added Supplement 22.<br>Added page. | <br>Wayne E. Gaulzetti<br>October 24, 2011 |

**PILOT'S OPERATING HANDBOOK LOG OF REVISIONS (cont)**

| Revision Number and Code | Revised Pages | Description of Revisions | FAA Approved Signature and Date |
|--------------------------|---------------|--------------------------|---------------------------------|
|                          |               |                          |                                 |



**TABLE OF CONTENTS**

|                   |  |
|-------------------|--|
| <b>SECTION 1</b>  | <b>GENERAL</b>   |
| <b>SECTION 2</b>  | <b>LIMITATIONS</b>   |
| <b>SECTION 3</b>  | <b>EMERGENCY PROCEDURES</b>  |
| <b>SECTION 4</b>  | <b>NORMAL PROCEDURES</b>   |
| <b>SECTION 5</b>  | <b>PERFORMANCE</b>   |
| <b>SECTION 6</b>  | <b>WEIGHT AND BALANCE</b>  |
| <b>SECTION 7</b>  | <b>DESCRIPTION AND OPERATION OF<br/>THE AIRPLANE AND ITS SYSTEMS</b> |
| <b>SECTION 8</b>  | <b>AIRPLANE HANDLING, SERVICING<br/>AND MAINTENANCE</b>              |
| <b>SECTION 9</b>  | <b>SUPPLEMENTS</b>   |
| <b>SECTION 10</b> | <b>OPERATING TIPS</b>  |

**THIS PAGE INTENTIONALLY LEFT BLANK**

TABLE OF CONTENTS  
SECTION 1  
GENERAL

| Paragraph No. |  | Page No. |
|---------------|--|----------|
| 1.1           | Introduction .....                           | 1-1      |
| 1.3           | Engines .....                                | 1-3      |
| 1.5           | Propellers.....                              | 1-3      |
| 1.7           | Fuel.....                                    | 1-4      |
| 1.9           | Oil.....                                     | 1-4      |
| 1.11          | Maximum Weights .....                        | 1-5      |
| 1.13          | Standard Airplane Weights.....               | 1-5      |
| 1.15          | Baggage Space .....                          | 1-5      |
| 1.17          | Specific Loadings.....                       | 1-5      |
| 1.19          | Symbols, Abbreviations and Terminology ..... | 1-6      |

**THIS PAGE INTENTIONALLY LEFT BLANK**



**SECTION I**

**GENERAL**

**1.1 INTRODUCTION**

This Pilot's Operating Handbook is designed for maximum utilization as an operating guide for the pilot. It includes the material required to be furnished to the pilot by the Federal Aviation Regulations and additional information provided by the manufacturer and constitutes the FAA Approved Airplane Flight Manual.

This handbook is not designed as a substitute for adequate and competent flight instruction, knowledge of current airworthiness directives, applicable federal air regulations or advisory circulars. It is not intended to be a guide for basic flight instruction or a training manual and should not be used for operational purposes unless kept in a current status.

Assurance that the airplane is in an airworthy condition is the responsibility of the owner. The pilot in command is responsible for determining that the airplane is safe for flight. The pilot is also responsible for remaining within the operating limitations as outlined by instrument markings, placards, and this handbook.

Although the arrangement of this handbook is intended to increase its in-flight capabilities, it should not be used solely as an occasional operating reference. The pilot should study the entire handbook to familiarize himself with the limitations, performance, procedures and operational handling characteristics of the airplane before flight.

The handbook has been divided into numbered (arabic) sections, each provided with a finger-tip tab divider for quick reference. The limitations and emergency procedures have been placed ahead of the normal procedures, performance and other sections to provide easier access to information that may be required in flight. The Emergency Procedures Section has been furnished with a red tab divider to present an instant reference to the section. Provisions for expansion of the handbook have been made by the deliberate omission of certain paragraph numbers, figure numbers, item numbers and pages noted as being intentionally left blank.

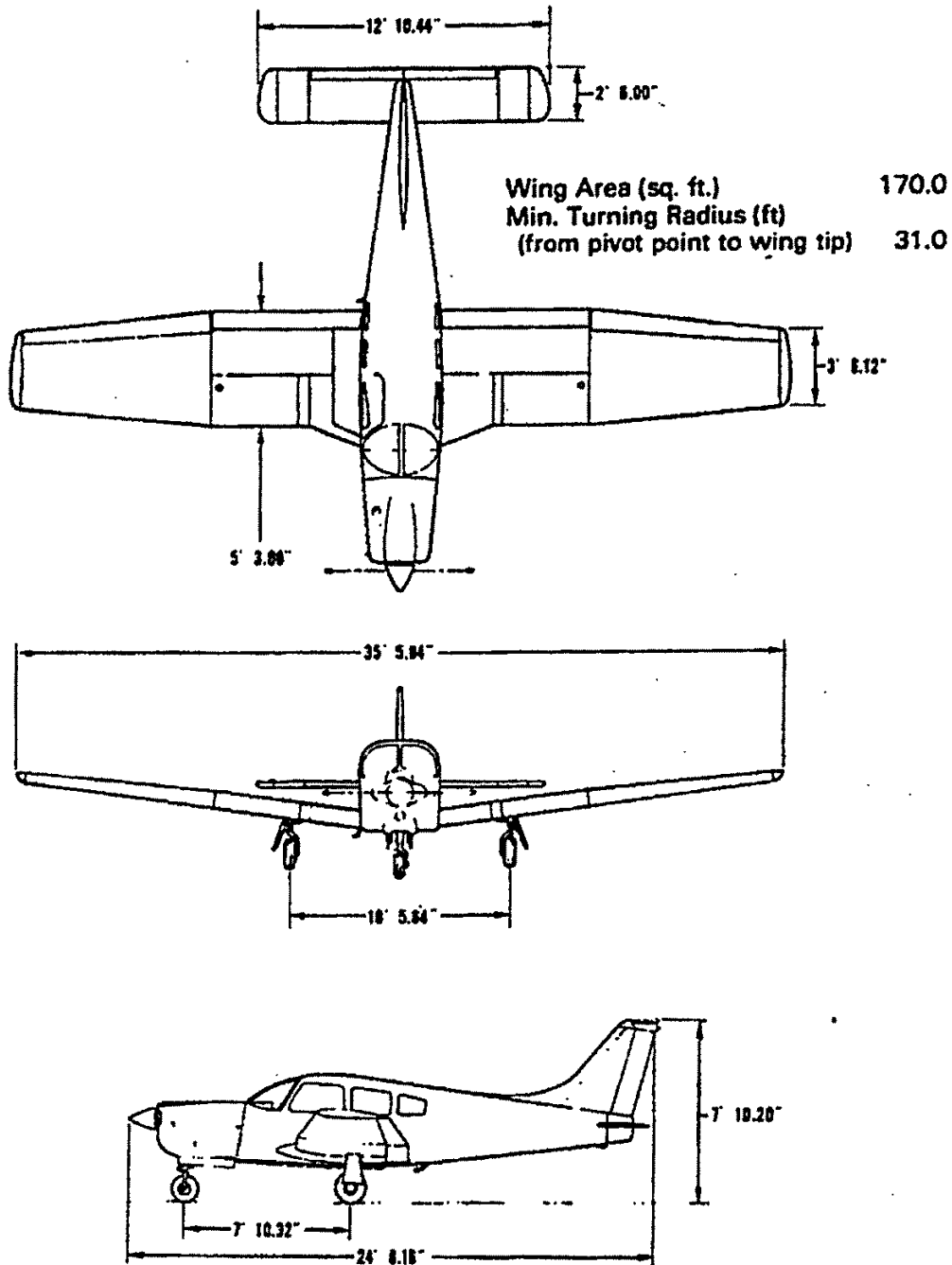

**THREE VIEW**  
Figure 1-1

**1.3 ENGINES**

|                            |  |
|----------------------------|--|
| (a) Number of Engines      | 1  |
| (b) Engine Manufacturer    | Lycoming   |
| (c) Engine Model Number    | IO-360-C1C6  |
| (d) Rated Horsepower       | 200  |
| (e) Rated Speed (rpm)      | 2700   |
| (f) Bore (in.)             | 5.125  |
| (g) Stroke (in.)           | 4.375  |
| (h) Displacement (cu. in.) | 361  |
| (i) Compression Ratio      | 8.7:1  |
| (j) Engine Type            | Four Cylinder, Direct<br>Drive, Horizontally<br>Opposed, Air Cooled<br>and Fuel Injected |

**1.5 PROPELLERS****McCAULEY**

|                              |   |
|------------------------------|---|
| (a) Number of Propellers     | 1   |
| (b) Propeller Manufacturer   | McCauley                                  |
| (c) Blade Model              | 90DHA-16                                  |
| (d) Number of Blades         | 2   |
| (e) Hub Model                | B2D34C213                                 |
| (f) Propeller Diameter (in.) |   |
| (1) Maximum                  | 74  |
| (2) Minimum                  | 73  |
| (g) Propeller Type           | Constant Speed,<br>Hydraulically Actuated |

**1.5 PROPELLERS (continued)**

**HARTZELL**

- (a) Number of Propellers 1
- (b) Propeller Manufacturer Hartzell
- (c) Blade Model F7666A-2R
- (d) Number of Blades 2
- (e) Hub Model HC-C2YK-1( )F/
- (f) Propeller Diameter (in.)
  - (1) Maximum 74
  - (2) Minimum 72
- (g) Propeller Type Constant Speed,  
Hydraulically Actuated

**1.7 FUEL**

- (a) Fuel Capacity (U.S. gal.) (total) 77
- (b) Usable Fuel (U.S. gal.) (total) 72
- (c) Fuel Grade, Aviation
  - (1) Minimum Octane 100/130 - Green or  
100 LL - Blue  
Aviation Grade
  - (2) Alternate Fuels Refer to latest revision  
of Lycoming Service  
Instruction 1070,  
except alcohol is not  
approved for use in this  
airplane. MIL-I-27686D  
is approved.

**1.9 OIL**

- (a) Oil Capacity (U.S. qts.) 8
- (b) Oil Specification Refer to latest issue  
of Lycoming Service  
Instruction 1014
- (c) Oil Viscosity Refer to Section 8 -  
paragraph 8.19

**1.11 MAXIMUM WEIGHTS**

|   |      |
|---|------|
| (a) Maximum Takeoff Weight (lb.)              | 2750 |
| (b) Maximum Landing Weight (lb.)              | 2750 |
| (c) Maximum Weights in Baggage<br>Compartment | 200  |

**1.13 STANDARD AIRPLANE WEIGHTS\***

|  |      |
|--|------|
| (a) Standard Empty Weight (lb.):<br>Weight of a standard airplane including unusable fuel, full operating fluids and full oil. | 1603 |
| (b) Maximum Useful Load (lb.): The difference between the Maximum Takeoff Weight and the Standard Empty Weight.                | 1147 |

**1.15 BAGGAGE SPACE**

|                                  |    |
|----------------------------------|----|
| (a) Compartment Volume (cu. ft.) | 24 |
| (b) Entry Width (in.)            | 22 |
| (c) Entry Height (in.)           | 20 |

**1.17 SPECIFIC LOADINGS**

|                                    |       |
|------------------------------------|-------|
| (a) Wing Loading (lb. per sq. ft.) | 16.18 |
| (b) Power Loading (lb. per hp)     | 13.75 |

\*These values are approximate and vary from one aircraft to another. Refer to Figure 6-5 for the Standard Empty Weight value and the Useful Load value to be used for C.G. calculations for the aircraft specified.

**1.19 SYMBOLS, ABBREVIATIONS AND TERMINOLOGY**

The following definitions are of symbols, abbreviations and terminology used throughout the handbook and those which may be of added operational significance to the pilot.

(a) **General Airspeed Terminology and Symbols**

**CAS** Calibrated Airspeed means the indicated speed of an aircraft, corrected for position and instrument error. Calibrated airspeed is equal to true airspeed in standard atmosphere at sea level.

**KCAS** Calibrated Airspeed expressed in Knots.

**GS** Ground Speed is the speed of an airplane relative to the ground.

**IAS** Indicated Airspeed is the speed of an aircraft as shown on the airspeed indicator when corrected for instrument error. IAS values published in this handbook assume zero instrument error.

**KIAS** Indicated Airspeed expressed in Knots.

**M** Mach Number is the ratio of true airspeed to the speed of sound.

**TAS** True Airspeed is the airspeed of an airplane relative to undisturbed air which is the CAS corrected for altitude, temperature and compressibility.

**V<sub>A</sub>** Maneuvering Speed is the maximum speed at which application of full available aerodynamic control will not overstress the airplane.

**V<sub>FE</sub>** Maximum Flap Extended Speed is the highest speed permissible with wing flaps in a prescribed extended position.

**1.19 SYMBOLS, ABBREVIATIONS, AND TERMINOLOGY (continued)**

|         |  |
|---------|--|
| VLE     | Maximum Landing Gear Extended Speed is the maximum speed at which an aircraft can be safely flown with the landing gear extended.    |
| VLO     | Maximum Landing Gear Operating Speed is the maximum speed at which the landing gear can be safely extended or retracted.             |
| VNE/MNE | Never Exceed Speed or Mach Number is the speed limit that may not be exceeded at any time.   |
| VNO     | Maximum Structural Cruising Speed is the speed that should not be exceeded except in smooth air and then only with caution.          |
| Vs      | Stalling Speed or the minimum steady flight speed at which the airplane is controllable.   |
| VSO     | Stalling Speed or the minimum steady flight speed at which the airplane is controllable in the landing configuration.                |
| VX      | Best Angle-of-Climb Speed is the airspeed which delivers the greatest gain of altitude in the shortest possible horizontal distance. |
| VY      | Best Rate-of-Climb Speed is the airspeed which delivers the greatest gain in altitude in the shortest possible time.                 |

**1.19 SYMBOLS, ABBREVIATIONS, AND TERMINOLOGY (continued)**

**(b) Meteorological Terminology**

|                             |  |
|-----------------------------|--|
| ISA                         | International Standard Atmosphere in which:<br>(1) The air is a dry perfect gas.<br>(2) The temperature at sea level is 15° Celsius (59° Fahrenheit).<br>(3) The pressure at sea level is 29.92 inches Hg (1013.2mb).<br>(4) The temperature gradient from sea level to the altitude at which the temperature is -56.5°C (-69.7°F) is 0.00198°C (-0.003564°F) per foot and zero above that altitude. |
| OAT                         | Outside Air Temperature is the free air static temperature, obtained either from inflight temperature indications or ground meteorological sources, adjusted for instrument error and compressibility effects.   |
| Indicated Pressure Altitude | The number actually read from an altimeter when the barometric subscale has been set to 29.92 inches of mercury (1013.2 millibars).  |
| Pressure Altitude           | Altitude measured from standard sea-level pressure (29.92 in. Hg) by a pressure or barometric altimeter. It is the indicated pressure altitude corrected for position and instrument error. In this handbook, altimeter instrument errors are assumed to be zero.  |
| Station Pressure            | Actual atmospheric pressure at field elevation.  |
| Wind                        | The wind velocities recorded as variables on the charts of this handbook are to be understood as the headwind or tailwind components of the reported winds.  |



**1.19 SYMBOLS, ABBREVIATIONS, AND TERMINOLOGY (continued)****(c) Power Terminology**

|                          |   |
|--------------------------|---|
| Takeoff Power            | Maximum power permissible for takeoff.                |
| Maximum Continuous Power | Maximum power permissible continuously during flight. |
| Maximum Climb Power      | Maximum power permissible during climb.               |
| Maximum Cruise Power     | Maximum power permissible during cruise.              |

**(d) Engine Instruments**

|           |                               |
|-----------|-------------------------------|
| EGT Gauge | Exhaust Gas Temperature Gauge |
|-----------|-------------------------------|

**(e) Airplane Performance and Flight Planning Terminology**

|                                 |  |
|---------------------------------|--|
| Climb Gradient                  | The demonstrated ratio of the change in height during a portion of a climb, to the horizontal distance traversed in the same time interval.  |
| Demonstrated Crosswind Velocity | The demonstrated crosswind velocity is the velocity of the crosswind component for which adequate control of the airplane during takeoff and landing was actually demonstrated during certification tests. |
| Accelerate-Stop Distance        | The distance required to accelerate an airplane to a specified speed and, assuming failure of an engine at the instant that speed is attained, to bring the airplane to a stop.                            |
| MEA                             | Minimum en route IFR altitude.   |
| Route Segment                   | A part of a route. Each end of that part is identified by: (1) a geographical location; or (2) a point at which a definite radio fix can be established.   |

**1.19 SYMBOLS, ABBREVIATIONS, AND TERMINOLOGY (continued)**

**(f) Weight and Balance Terminology**

|                          |   |
|--------------------------|---|
| Reference Datum          | An imaginary vertical plane from which all horizontal distances are measured for balance purposes.  |
| Station                  | A location along the airplane fuselage usually given in terms of distance from the reference datum.   |
| Arm                      | The horizontal distance from the reference datum to the center of gravity (C.G.) of an item.  |
| Moment                   | The product of the weight of an item multiplied by its arm. (Moment divided by a constant is used to simplify balance calculations by reducing the number of digits.)       |
| Center of Gravity (C.G.) | The point at which an airplane would balance if suspended. Its distance from the reference datum is found by dividing the total moment by the total weight of the airplane. |
| C.G. Arm                 | The arm obtained by adding the airplane's individual moments and dividing the sum by the total weight.  |
| C.G. Limits              | The extreme center of gravity locations within which the airplane must be operated at a given weight.   |
| Usable Fuel              | Fuel available for flight planning.   |
| Unusable Fuel            | Fuel remaining after a runout test has been completed in accordance with governmental regulations.  |
| Standard Empty Weight    | Weight of a standard airplane including unusable fuel, full operating fluids and full oil.  |

**1.19 SYMBOLS, ABBREVIATIONS, AND TERMINOLOGY (continued)**

|                          |   |
|--------------------------|---|
| Basic Empty Weight       | Standard empty weight plus optional equipment.  |
| Payload                  | Weight of occupants, cargo and baggage.   |
| Useful Load              | Difference between takeoff weight, or ramp weight if applicable, and basic empty weight.          |
| Maximum Ramp Weight      | Maximum weight approved for ground maneuver. (It includes weight of start, taxi and run up fuel.) |
| Maximum Takeoff Weight   | Maximum weight approved for the start of the takeoff run.   |
| Maximum Landing Weight   | Maximum weight approved for the landing touchdown.  |
| Maximum Zero Fuel Weight | Maximum weight exclusive of usable fuel.  |

**THIS PAGE INTENTIONALLY LEFT BLANK**

**TABLE OF CONTENTS**

**SECTION 2  
LIMITATIONS**

| <b>Paragraph<br/>No.</b> |                                      | <b>Page<br/>No.</b> |
|--------------------------|--------------------------------------|---------------------|
| 2.1                      | General .....                        | 2-1                 |
| 2.3                      | Airspeed Limitations .....           | 2-1                 |
| 2.5                      | Airspeed Indicator Markings.....     | 2-2                 |
| 2.7                      | Power Plant Limitations .....        | 2-3                 |
| 2.9                      | Power Plant Instrument Markings..... | 2-4                 |
| 2.11                     | Weight Limits .....                  | 2-5                 |
| 2.13                     | Center of Gravity Limits .....       | 2-5                 |
| 2.15                     | Maneuver Limits .....                | 2-5                 |
| 2.17                     | Flight Load Factors .....            | 2-6                 |
| 2.19                     | Types of Operations.....             | 2-6                 |
| 2.21                     | Fuel Limitations .....               | 2-6                 |
| 2.23                     | Placards .....                       | 2-8                 |

**THIS PAGE INTENTIONALLY LEFT BLANK**

SECTION 2  
LIMITATIONS

## 2.1 GENERAL

This section provides the FAA Approved operating limitations, instrument markings, color coding and basic placards necessary for the safe operation of the airplane and its systems.

Limitations associated with those optional systems and equipment which require handbook supplements can be found in Section 9 (Supplements).

## 2.3 AIRSPEED LIMITATIONS

| SPEED   | KIAS | KCAS |
|---|------|------|
| Never Exceed Speed (VNE) - Do not exceed this speed in any operation.   | 183  | 186  |
| Maximum Structural Cruising Speed (VNO) - Do not exceed this speed except in smooth air and then only with caution. | 146  | 148  |
| Design Maneuvering Speed (VA) - Do not make full or abrupt control movements above this speed.                      |      |      |
| At 2750 lbs. G.W.   | 118  | 120  |
| At 1865 lbs. G.W.   | 96   | 96   |

**CAUTION**

Maneuvering speed decreases at lighter weight as the effects of aerodynamic forces become more pronounced. Linear interpolation may be used for intermediate gross weights. Maneuvering speed should not be exceeded while operating in rough air.

**2.3 AIRSPEED LIMITATIONS (continued)**

| <b>SPEED</b>  | <b>KIAS</b> | <b>KCAS</b> |
|---|-------------|-------------|
| Maximum Flaps Extended Speed (V <sub>FE</sub> ) -<br>Do not exceed this speed with the flaps<br>extended.               | 103         | 103         |
| Maximum Landing Gear Extension Speed -<br>Do not exceed this speed when extending<br>the landing gear.                  | 129         | 130         |
| Maximum Landing Gear Retraction Speed -<br>Do not exceed this speed when retracting<br>the landing gear.                | 107         | 107         |
| Maximum Landing Gear Extended Speed<br>(V <sub>LE</sub> ) - Do not exceed this speed with the<br>landing gear extended. | 129         | 130         |

**2.5 AIRSPEED INDICATOR MARKINGS**

| <b>MARKING</b>                                  | <b>IAS</b>         |
|---|--------------------|
| Red Radial Line (Never Exceed)                  | 183 KTS            |
| Yellow Arc<br>(Caution Range - Smooth Air Only) | 146 KTS to 183 KTS |
| Green Arc (Normal Operating Range)              | 60 KTS to 146 KTS  |
| White Arc (Flap Down)                           | 55 KTS to 103 KTS  |



## 2.7 POWER PLANT LIMITATIONS

|  |   |
|--|---|
| (a) Number of Engines                            | 1   |
| (b) Engine Manufacturer                          | Lycoming  |
| (c) Engine Model No.                             | IO-360-C1C6   |
| (d) Engine Operating Limits                      |   |
| (1) Maximum Horsepower                           | 200   |
| (2) Maximum Rotation Speed (RPM)                 | 2700  |
| (3) Maximum Oil Temperature                      | 245°F   |
| (e) Oil Pressure                                 |   |
| Minimum (red line)                               | 25 PSI  |
| Maximum (red line)                               | 100 PSI   |
| (f) Fuel Flow/Pressure                           |   |
| Maximum (red line)                               | 21.4 GPH/12 PSI   |
| (g) Fuel Grade (minimum octane)                  | 100 or 100LL<br>Aviation Grade  |
| (h) Number of Propellers                         | 1   |
| (i) Propeller Manufacturer                       | McCauley or Hartzell  |
| (j) Propeller Hub and Blade Model                |   |
| (1) McCauley                                     | B2D34C213/90DHA-16  |
| (2) Hartzell                                     | HC-C2YK-1( )F/<br>F7666A-2R   |
| (k) Propeller Diameter                           |   |
| (1) McCauley                                     |   |
| Minimum  | 73  |
| Maximum  | 74  |
| (2) Hartzell                                     |   |
| Minimum  | 72  |
| Maximum  | 74  |
| (l) Blade Angle Limits                           |   |
| (1) McCauley                                     |   |
| Low Pitch Stop                                   | 12.5 + 0.2°   |
| High Pitch Stop                                  | 27.5 + 0.5°   |
| (2) Hartzell                                     |   |
| Low Pitch Stop                                   | 14.0 + 0.2°   |
| High Pitch Stop                                  | 29.0 + 2.0°   |
| (m) RPM Restriction<br>(McCauley Propeller Only) | Avoid continuous<br>operation between<br>1500 and 1950 rpm<br>below 15 inches<br>manifold pressure. |

**2.9 POWER PLANT INSTRUMENT MARKINGS**

- |  |                                      |
|--|--------------------------------------|
| (a) Tachometer                                 |                                      |
| Green Arc (Normal Operating Range)             | 500 to 2700 RPM                      |
| Red Line (Maximum Continuous Power)            | 2700 RPM                             |
| (b) Oil Temperature                            |                                      |
| Green Arc (Normal Operating Range)             | 75° to 245°F                         |
| Red Line (Maximum)                             | 245°F                                |
| (c) Oil Pressure                               |                                      |
| Green Arc (Normal Operating Range)             | 60 PSI to 90 PSI                     |
| Yellow Arc (Caution Range) (Idle)              | 25 PSI to 60 PSI                     |
| Yellow Arc (Caution Range) (Start and Warm-up) | 90 PSI to 100 PSI                    |
| Red Line (Minimum)                             | 25 PSI                               |
| Red Line (Maximum)                             | 100 PSI                              |
| (d) Fuel Flow/ Pressure                        |                                      |
| Green Arc (Normal Operating Range)             | 2 GPH/0.05 PSI<br>to 21.4 GPH/12 PSI |
| Red Line (Maximum)                             | 21.4 GPH/12 PSI                      |

**2.11 WEIGHT LIMITS**

- (a) Maximum Weight 2750 LBS.
- (b) Maximum Baggage 200 LBS.

**NOTE**

Refer to Section 5 (Performance) for maximum weight as limited by performance.

**2.13 CENTER OF GRAVITY LIMITS**

| Weight<br>Pounds  | Forward Limit<br>Inches Aft of Datum | Rearward Limit<br>Inches Aft of Datum |
|-------------------|--------------------------------------|---------------------------------------|
| 2750              | 88.9                                 | 91.5                                  |
| 2375 and<br>Below | 82.0                                 | 91.5                                  |

**NOTES**

Straight line variation between points given.

The datum used is 78.4 inches ahead of the wing leading edge at the intersection of the straight and tapered section.

It is the responsibility of the airplane owner and the pilot to insure that the airplane is properly loaded. See Section 6 (Weight and Balance) for proper loading instructions.

**2.15 MANEUVER LIMITS**

No acrobatic maneuvers including spins.

Approved maneuvers which do not exceed 60° of bank and 30° of pitch:

- Steep Turns
- Lazy Eights
- Chandelles

**2.17 FLIGHT LOAD FACTORS**

- (a) Positive Load Factor (Maximum)
- (b) Negative Load Factor (Maximum)

3.8 G  
No inverted maneuver  
approved

**2.19 TYPES OF OPERATIONS**

The airplane is approved for the following operations when equipped in accordance with FAR 91 or FAR 135.

- (a) Day V.F.R.
- (b) Night V.F.R.
- (c) Day I.F.R.
- (d) Night I.F.R.
- (e) Non Icing

**2.21 FUEL LIMITATIONS**

- (a) Total Capacity
- (b) Unusable Fuel

77 U.S. GAL.  
5 U.S. GAL.

The unusable fuel for this airplane has been determined as 2.5 gallons in each wing tank in critical flight attitudes.

- (c) Usable Fuel

72 U.S. GAL.

The usable fuel in this airplane has been determined as 36.0 gallons in each wing tank.

- (d) Fuel remaining when the quantity indicators read zero cannot be used safely in flight.

2.23 PLACARDS

In full view of the pilot:

|  |   |
|--|---|
| <p style="text-align: center;"><b>LIMITATIONS</b></p> <p>THIS AIRCRAFT APPROVED FOR NIGHT I.F.R., NON-ICING FLIGHT WHEN EQUIPPED IN ACCORDANCE WITH FAR 91 OR FAR 135. NO ACROBATIC MANEUVERS, INCLUDING SPINS, APPROVED. THIS AIRCRAFT MUST BE OPERATED AS A NORMAL CATEGORY AIRPLANE IN COMPLIANCE WITH THE OPERATING LIMITATIONS STATED IN THE FORM OF PLACARDS, MARKINGS AND MANUALS. FUEL REMAINING WHEN THE QUANTITY INDICATORS READ ZERO CANNOT BE USED SAFELY IN FLIGHT.</p> | <p style="text-align: center;"><b>INFORMATION</b></p> <p>OIL COOLER WINTERIZATION PLATE TO BE REMOVED WHEN AMBIENT TEMPERATURE EXCEEDS 50°F.</p> <p style="text-align: center;"><b>WARNING</b></p> <p>TURN OFF STROBE LIGHTS WHEN IN CLOSE PROXIMITY TO GROUND OR DURING FLIGHT THROUGH CLOUD, FOG OR HAZE.</p> <p style="text-align: right; font-size: small;">30849-140</p> |
|--|---|

On the instrument panel in full view of the pilot (not required if Avidyne Entegra is installed):

NO ACROBATIC MANEUVERS,  
INCLUDING SPINS, APPROVED

Above fuel quantity gauges (not required if Avidyne Entegra is installed):

FUEL REMAINING WHEN THE QUANTITY  
INDICATORS READ ZERO CANNOT BE USED  
SAFELY IN FLIGHT.

On the instrument panel in full view of the pilot (not required if Avidyne Entegra is installed):

**W A R N I N G**

TURN OFF STROBE LIGHTS WHEN IN  
CLOSE PROXIMITY TO GROUND OR  
DURING FLIGHT THROUGH CLOUD,  
FOG OR HAZE.

On the instrument panel in full view of the pilot:

|           |                 |
|-----------|-----------------|
| GEAR DOWN | 129 KIAS (MAX.) |
| GEAR UP   | 107 KIAS (MAX.) |
| EXTENDED  | 129 KIAS (MAX.) |

**2.23 PLACARDS (continued)**

(Serial Numbers 2844001 through 2844021 only) In full view of the pilot, the following Takeoff and Landing Checklists will be installed:

**TAKEOFF CHECKLIST**

|                       |                      |
|-----------------------|----------------------|
| Fuel on Proper Tank   | Fasten Belts/Harness |
| Electric Fuel Pump On | Flaps Set            |
| Engine Gauges Checked | Trim Tab Set         |
| Alternate Air Closed  | Controls Free        |
| Seat Backs Erect      | Doors Latched        |
| Mixture Set           | Air Conditioner Off  |
| Propeller Set         |                      |

**LANDING CHECKLIST**

|                       |                       |
|-----------------------|-----------------------|
| Fuel on Proper Tank   | Propeller Set         |
| Seat Backs Erect      | Gear Down             |
| Fasten Belts/Harness  | Flaps Set (White Arc) |
| Electric Fuel Pump On | Air Conditioner Off   |
| Mixture Rich          |                       |

The Air Conditioner Off item in the above Takeoff and Landing Checklists is mandatory for air conditioned aircraft only.

On the instrument panel in full view of the pilot (not required if Avidyne Entegra is installed):

**MANEUVERING SPEED 118 KIAS  
AT 2750 LBS. (SEE P.O.H.)**

On the instrument panel in full view of the pilot (not required if Avidyne Entegra is installed):

**DEMONSTRATED CROSSWIND COMPONENT 17 KTS**

On the instrument panel in full view of the pilot (only required if Avidyne Entegra is installed):

**V<sub>A</sub> - 118 KIAS  
AT 2750#(SEE POH)  
DEMO. X-WIND 17 KTS.**

**NOTE**

Demonstrated crosswind values are NOT limitations.

**2.23 PLACARDS (continued)**

On the instrument panel in full view of the pilot in aircraft with McCauley propeller installations only:

AVOID CONTINUOUS OPERATIONS BETWEEN  
1500 AND 1950 RPM BELOW 15" MANIFOLD  
PRESSURE.

In full view of pilot:

CAUTION  
COMPASS  
CAL. MAY  
BE IN ERROR  
WITH ELECT.  
EQUIPMENT  
OTHER THAN  
AVIONICS ON

In full view of the pilot, in the area of the air conditioner controls, when the air conditioner is installed:

WARNING  
AIRCONDITIONER MUST BE OFF TO INSURE  
NORMAL TAKEOFF CLIMB PERFORMANCE.

In full view of the pilot and passengers (serial numbers 2844012 and up):

NO SMOKING

Near emergency gear lever:

EMERGENCY DOWN

Near gear selector switch:

GEAR UP                      107 KIAS MAX.  
DOWN                         129 KIAS MAX.

**2.23 PLACARDS (continued)**

On the aft baggage closeout:

**MAXIMUM BAGGAGE 200 LBS. NO HEAVY  
OBJECTS ON HAT SHELF.**

Adjacent to upper door latch:

**ENGAGE LATCH BEFORE FLIGHT**

On inside of baggage compartment door:

**BAGGAGE MAX. 200 LBS. SEE WEIGHT AND  
BALANCE DATA FOR BAGGAGE LOADINGS  
BETWEEN 150 LBS. AND 200 LBS.**

Adjacent to fuel tank filler caps:

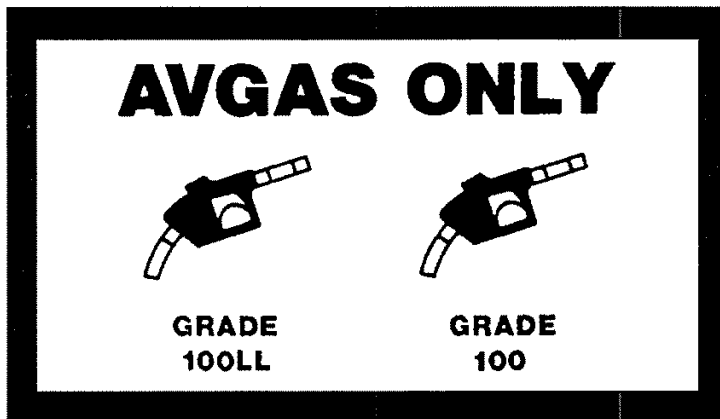



( HB-2008-135R1 )

Text LFA 2008-135R1  
AFM (sect. "limitations")

ATTN: Solomon Hecht, Aerospace Engineer, Boston ACO, 12 New England Executive Park, Burlington, MA 01803; telephone: (781) 238-7159; fax: (781) 238-7170. Before using any approved AMOC on any airplane to which the AMOC applies, notify your appropriate principal inspector (PI) in the FAA Flight Standards District Office (FSDO), or lacking a PI, your local FSDO.

#### **Additional Information**

(g) For the service alert referenced in this AD, contact Avidyne Corporation, 55 Old Bedford Road, Lincoln, MA 01773; telephone: (781) 402-7400; fax: (781) 402-7599.

#### **Appendix to AD 2008-06-28 R1 Limitations Regarding Avidyne Primary Flight Displays (PFDs)**

Before conducting flight operations, pilots must review and be familiar with the Crosscheck Monitor section of the Avidyne Primary Flight Display Pilot's Guide and all limitations contained in the airplane flight manual, pilot's operating handbook, or aircraft operating handbook.

As a normal practice, all pilots should be vigilant in conducting proper preflight and in-flight checks of instrument accuracy, including:

- Preflight check of the accuracy of both the primary and backup altimeter against known airfield elevation and against each other.
- Verification of airspeed indications consistent with prevailing conditions at startup, during taxi, and prior to takeoff.
- "Airspeed alive" check and reasonable indications during takeoff roll.
- Maintenance of current altimeter setting in both primary and backup altimeters.
- Cross-check of primary and backup altimeters at each change of altimeter setting and prior to entering instrument meteorological conditions (IMC).
- Cross-check of primary and backup altimeters and validation against other available data, such as glideslope intercept altitude, prior to conducting any instrument approach.
- Periodic cross-checks of primary and backup airspeed indicators, preferably in combination with altimeter cross-checks.

For flight operations under instrument flight rules (IFR) or in conditions in which visual reference to the horizon cannot be reliably maintained (that is IMC, night operations, flight operations over water, in haze or smoke) and the pilot has reasons to suspect that any source (PFD or back-up instruments) of attitude, airspeed, or altitude is not functioning properly, flight under IFR or in these conditions must not be initiated (when condition is determined on the ground) and further flight under IFR or in these conditions is prohibited until equipment is serviced and functioning properly.

Operation of aircraft not equipped with operating backup (or standby) attitude, altimeter, and airspeed indicators that are located where they are readily visible to the pilot is prohibited.

Pilots must frequently scan and cross-check flight instruments to make sure the information depicted on the PFD correlates and agrees with the information depicted on the backup instruments.

Issued in Kansas City, Missouri, on April 4, 2008.

David R. Showers,

Acting Manager, Small Airplane Directorate, Aircraft Certification Service.

[FR Doc. E8-7802 Filed 4-11-08; 8:45 am]

**TABLE OF CONTENTS**

**SECTION 3**

**EMERGENCY PROCEDURES**

| Paragraph<br>No. |   | Page<br>No. |
|------------------|---|-------------|
| 3.1              | General .....                                 | 3-1         |
| 3.3              | Airspeeds For Safe Operation .....            | 3-2         |
| 3.5              | Emergency Procedures Checklist.....           | 3-3         |
| 3.5a             | Engine Fire During Start (3.9) .....          | 3-3         |
| 3.5b             | Engine Power Loss During Takeoff (3.11) ..... | 3-3         |
| 3.5c             | Engine Power Loss In Flight (3.13).....       | 3-3         |
| 3.5d             | Power Off Landing (3.15).....                 | 3-4         |
|                  | Gear Down Emergency Landing (3.15a).....      | 3-4         |
|                  | Gear Up Emergency Landing (3.15b) .....       | 3-5         |
| 3.5e             | Fire In Flight (3.17).....                    | 3-5         |
| 3.5f             | Loss Of Oil Pressure (3.19) .....             | 3-6         |
| 3.5g             | Loss Of Fuel Flow/Pressure (3.21) .....       | 3-6         |
| 3.5h             | High Oil Temperature (3.23).....              | 3-6         |
| 3.5i             | Electrical Failure (3.25) .....               | 3-6         |
| 3.5j             | Electrical Overload (3.27).....               | 3-6         |
| 3.5k             | Propeller Overspeed (3.29) .....              | 3-7         |
| 3.5m             | Emergency Landing Gear Extension (3.31).....  | 3-8         |
| 3.5n             | Spin Recovery (3.33) .....                    | 3-9         |
| 3.5o             | Open Door (3.35).....                         | 3-9         |
| 3.5p             | Engine Roughness (3.37).....                  | 3-9         |

**TABLE OF CONTENTS**

**SECTION 3**

**EMERGENCY PROCEDURES (cont)**

| Paragraph No. |  | Page No. |
|---------------|--|----------|
| 3.7           | Amplified Emergency Procedures (General) ..... | 3-11     |
| 3.9           | Engine Fire During Start (3.5a).....           | 3-11     |
| 3.11          | Engine Power Loss During Takeoff (3.5b) .....  | 3-11     |
| 3.13          | Engine Power Loss In Flight (3.5c) .....       | 3-12     |
| 3.15          | Power Off Landing (3.5d) .....                 | 3-13     |
| 3.15a         | Gear Down Emergency Landing (3.5d) .....       | 3-14     |
| 3.15b         | Gear Up Emergency Landing (3.5d) .....         | 3-14     |
| 3.17          | Fire In Flight (3.5e) .....                    | 3-15     |
| 3.19          | Loss of Oil Pressure (3.5f) .....              | 3-15     |
| 3.21          | Loss of Fuel Flow/Pressure (3.5g) .....        | 3-16     |
| 3.23          | High Oil Temperature (3.5h).....               | 3-16     |
| 3.25          | Electrical Failure (3.5i) .....                | 3-16     |
| 3.27          | Electrical Overload (3.5j).....                | 3-17     |
| 3.29          | Propeller Overspeed (3.5k) .....               | 3-18     |
| 3.31          | Emergency Landing Gear Extension (3.5m).....   | 3-18     |
| 3.33          | Spin Recovery(3.5n).....                       | 3-19     |
| 3.35          | Open Door (3.5o) .....                         | 3-19     |
| 3.37          | Engine Roughness (3.5p) .....                  | 3-19     |

**SECTION 3****EMERGENCY PROCEDURES****3.1 GENERAL**

This section provides the recommended procedures for coping with various emergency or critical situations. All of the emergency procedures required by the FAA as well as those necessary for operation of the airplane, as determined by the operating and design features of the airplane, are presented.

Emergency procedures associated with optional systems and equipment which require handbook supplements are presented in Section 9, Supplements.

This section is divided into two basic parts. The first part contains the emergency procedures checklists. These checklists supply an immediate action sequence to be followed during critical situations with little emphasis on the operation of systems. The numbers located in parentheses after each checklist heading indicate where the corresponding paragraph in the amplified procedures can be found.

The second part of the section provides amplified emergency procedures corresponding to the emergency procedures checklist items. These amplified emergency procedures contain additional information to provide the pilot with a more complete description of the procedures so they may be more easily understood. The numbers located in parentheses after each paragraph heading indicates the corresponding checklist paragraph.

Pilots must familiarize themselves with the procedures given in this section and must be prepared to take the appropriate action should an emergency situation arise. The procedures are offered as a course of action for coping with the particular situation or condition described. They are not a substitute for sound judgment and common sense.

Most basic emergency procedures are a normal part of pilot training. The information presented in this section is not intended to replace this training. This information is intended to provide a source of reference for the procedures which are applicable to this airplane. The pilot should review standard emergency procedures periodically to remain proficient in them.

**3.3 AIRSPEEDS FOR SAFE OPERATION**

**3.3a STALL SPEEDS**

2750 lbs (Gear Up, 0 Flap) .....60 KIAS  
2750 lbs (Gear Down, 40 Flap) .....55 KIAS

**3.3b MANEUVERING SPEEDS**

2750 lbs.....118 KIAS  
1865 lbs.....96 KIAS

**3.3c NEVER EXCEED SPEED**

Never Exceed Speed .....183 KIAS

**3.3d POWER OFF GLIDE SPEED**

2750 lbs (Gear Up, 0 Flap) .....79 KIAS

**3.5 EMERGENCY PROCEDURES CHECKLIST**

**3.5a ENGINE FIRE DURING START (3.9)**

- Starter.....CRANK ENGINE
  - Mixture.....IDLE CUT-OFF
  - Throttle.....OPEN
  - Electric Fuel Pump.....OFF
  - Fuel Selector.....OFF
- Abandon if fire continues.

**3.5b ENGINE POWER LOSS DURING TAKEOFF (3.11)**

If sufficient runway remains for a normal landing, leave gear down and land straight ahead.

If area ahead is rough or if it is necessary to clear obstructions:

- Gear Selector Switch .....UP

If sufficient altitude has been gained to attempt a restart:

Maintain safe airspeed.

- Fuel Selector.....SWITCH to tank  
containing fuel
- Electric Fuel Pump .....CHECK ON
- Mixture.. .....CHECK RICH
- Alternate Air.....OPEN

If power is not regained, proceed with power off landing (3.5d).

**3.5c ENGINE POWER LOSS IN FLIGHT (3.13)**

**If at low altitude:**

- Airspeed .....MAINTAIN 79  
KIAS minimum

Prepare for power off landing (3.5d).

**If altitude permits:**

- Fuel Selector.....SWITCH to tank  
containing fuel

**3.5c ENGINE POWER LOSS IN FLIGHT (3.13) (continued)**

Electric fuel pump.....ON  
Mixture.....RICH  
Alternate Air.....OPEN  
Engine Gauges.....CHECK for indication  
of cause of power loss

If no fuel flow/pressure is indicated, check tank selector position to be sure it is on a tank containing fuel.

When power is restored:

Alternate Air .....CLOSE  
Electric Fuel Pump .....OFF

If power is not restored, prepare for power off landing.  
Trim for 79 KIAS.

**3.5d POWER OFF LANDING (3.15)**

Trim for 79 KIAS.  
Locate suitable field.  
Establish spiral pattern.  
1000 ft. above field at downwind position for normal landing approach.  
When field can be easily reached, slow to 72 KIAS for shortest landing.

**Gear Down Emergency Landing (3.15a)**

Touchdowns should normally be made at the lowest possible airspeed with full flaps.

When committed to landing:

Landing Gear Selector.....DOWN  
Flaps.....AS DESIRED  
Throttle.....CLOSE  
Mixture.....IDLE CUT-OFF  
Ignition .....OFF  
BATT MASTR Switch .....OFF  
ALTR Switch.....OFF  
Fuel Selector.....OFF  
Seat Belts and Harness.....TIGHT

**NOTE**

If battery master switch is OFF, the landing gear cannot be retracted.

**3.5d POWER OFF LANDING (3.15) (continued)**

**Gear Up Emergency Landing (3.15b)**

In the event a gear up landing is required, proceed as follows:

- Flaps .....AS DESIRED
  - Throttle.....CLOSE
  - Mixture.....IDLE CUT-OFF
  - Ignition .....OFF
  - BATT MASTR Switch .....OFF
  - ALTR Switch.....OFF
  - Fuel Selector.....OFF
  - Seat Belt and Harness .....TIGHT
- Contact surface at minimum possible airspeed.

**3.5e FIRE IN FLIGHT (3.17)**

- Source of Fire.....CHECK

**Electrical Fire (Smoke in Cabin):**

- BATT MASTR Switch .....OFF
  - ALTR Switch.....OFF
  - Vents .....OPEN
  - Cabin Heat.....OFF
- Land as soon as possible.

**Engine Fire:**

- Fuel Selector.....OFF
  - Throttle.....CLOSED
  - Mixture.....IDLE CUT-OFF
  - Electric Fuel Pump.....CHECK OFF
  - Heater and Defroster .....OFF
- Proceed with power off landing procedure (3.5d).

**NOTE**

The possibility of an engine fire in flight is extremely remote. The procedure given is general and pilot judgement should be the determining factor for action in such an emergency.



**3.5f LOSS OF OIL PRESSURE (3.19)**

Land as soon as possible and investigate cause.  
Prepare for power off landing.

**3.5g LOSS OF FUEL FLOW/PRESSURE (3.21)**

Electric Fuel Pump .....ON  
Fuel Selector .....CHECK on tank  
containing fuel

**3.5h HIGH OIL TEMPERATURE (3.23)**

Land at nearest airport and investigate the problem.  
Prepare for power off landing.

**3.5i ELECTRICAL FAILURE (3.25)**

ALT annunciator light illuminated:  
Ammeter .....CHECK to VERIFY  
inop. alt.

If ammeter shows zero:

ALTR Switch.....OFF

Reduce electrical loads to minimum:

ALTNTR. FIELD

Circuit Breaker .....CHECK and RESET  
as required

ALTR Switch .....ON

If power not restored:

ALTR Switch.....OFF

If alternator output cannot be restored, reduce electrical loads and land as soon as practical. The battery is the only remaining source of electrical power.

**3.5j ELECTRICAL OVERLOAD (Alternator over 20 amps above known electrical load) (3.27)**

BATT MASTR Switch.....OFF

**3.5j ELECTRICAL OVERLOAD (Alternator over 20 amps above known electrical load) (3.27) (Continued)**

**If ammeter reading does NOT decrease:**

ALTR Switch.....OFF  
Land as soon as possible. Use Emergency Landing Gear Extension (3.5m) to lower landing gear.

**If ammeter reading DOES decrease:**

BATT MASTR Switch .....ON  
Ammeter .....MONITOR

**If ammeter reading does NOT begin to decrease within five minutes:**

BATT MASTR Switch.....OFF  
Land as soon as possible.

**CAUTION**

If the battery is depleted, the landing gear must be lowered using the emergency extension procedure. The gear position lights will be inoperative.

**NOTE**

Due to increased system voltage and radio frequency noise, operation with ALTR switch ON and BATT switch OFF should be made only when required by an electrical system failure.

**If ammeter reading DOES begin to decrease within five minutes:**

Proceed with flight.  
Ammeter .....MONITOR

**3.5k PROPELLER OVERSPEED (3.29)**

Throttle.....RETARD  
Oil Pressure.....CHECK

**3.5k PROPELLER OVERSPEED (continued)**

Propeller Control.....FULL DECREASE  
rpm, then set if any  
control available.  
Airspeed.....REDUCE  
Throttle. ....AS REQUIRED to  
remain below 2700 rpm

**3.5m EMERGENCY LANDING GEAR EXTENSION (3.31)**

**NOTE**

Refer to paragraph 4.39 for differences when emergency gear extension is being performed for training purposes.

Prior to emergency extension procedure:

BATT MASTR Switch.....CHECK ON  
ALTR Switch.....CHECK ON  
Circuit Breakers .....CHECK  
NAV LIGHT Switch.....OFF (in daytime)  
Gear Indicator Bulbs .....CHECK

If landing gear does not check down and locked:

Airspeed.....REDUCE BELOW  
87 KIAS  
Landing Gear Selector Switch.....GEAR DOWN  
POSITION

If gear has still failed to lock down, move and *hold* the emergency lever down to the Emergency Down position.

If gear has still failed to lock down, yaw the airplane abruptly from side to side with the rudder.

If the nose gear will not lock down using the above procedure, slow the aircraft to the lowest safe speed attainable using the lowest power setting required for safe operation and accomplish the following:

Landing Gear Selector Switch.....GEAR DOWN  
POSITION

If landing gear does not check down, recycle gear through up position and then select gear DOWN.

**3.5n SPIN RECOVERY (3.33)**

Rudder.....FULL OPPOSITE to  
DIRECTION of ROTATION  
Control Wheel.....FULL FORWARD WHILE  
NEUTRALIZING AILERONS  
Throttle.....IDLE  
Rudder.....NEUTRAL (when rotation stops)  
Control Wheel.....AS REQUIRED to SMOOTHLY  
REGAIN LEVEL FLIGHT ATTITUDE

**3.5o OPEN DOOR (3.35)**

If both upper and side latches are open, the door will trail slightly open and airspeeds will be reduced slightly.

To close the door in flight:

Slow airplane to 87 KIAS.

Cabin Vents.....CLOSE  
Storm Window.....OPEN

If upper latch is open.....LATCH

If side latch is open.....PULL on ARMREST  
while moving Latch Handle to LATCH position If both latches are  
open.....LATCH SIDE LATCH  
then TOP LATCH

**3.5p ENGINE ROUGHNESS (3.37)**

Mixture.....ADJUST for maximum smoothness  
Alternate Air.....OPEN  
Electric Fuel Pump.....ON  
Fuel Selector.....SWITCH TANKS  
Engine Gauges.....CHECK  
Magneto Switch.....L then R then  
BOTH

If operation is satisfactory on either magneto, proceed on that magneto at reduced power, with full RICH mixture, to a landing at the first available airport.

If roughness persists, prepare for a precautionary landing.

**THIS PAGE INTENTIONALLY LEFT BLANK**

**3.7 AMPLIFIED EMERGENCY PROCEDURES (GENERAL)**

The following paragraphs are presented to supply additional information for the purpose of providing the pilot with a more complete understanding of the recommended course of action and probable cause of an emergency situation.

**3.9 ENGINE FIRE DURING START (3.5a)**

Engine fires during start are usually the result of overpriming. The first attempt to extinguish the fire is to try to start the engine and draw the excess fuel back into the induction system.

If a fire is present before the engine has started, move the mixture control to idle cut-off, open the throttle and crank the engine. This is an attempt to draw the fire back into the engine.

If the engine has started, continue operating to try to pull the fire into the engine.

In either of the above cases, if fire continues for more than a few seconds, the fire should be extinguished by the best available external means.

The fuel selector valves should be OFF and the mixture at idle cut-off if an external fire extinguishing method is to be used.

**3.11 ENGINE POWER LOSS DURING TAKEOFF (3.5b)**

The proper action to be taken if loss of power occurs during takeoff will depend on the circumstances of the particular situation.

If sufficient runway remains to complete a normal landing, leave the landing gear down and land straight ahead.

If the area ahead is rough, or if it is necessary to clear obstructions, move the gear selector switch to the UP position.

If sufficient altitude has been gained to attempt a restart, maintain a safe airspeed and switch the fuel selector to a tank containing fuel. Place the electric fuel pump to ON. Check that the mixture is RICH. The alternate air should be open.

**3.11 ENGINE POWER LOSS DURING TAKEOFF (3.5b) (continued)**

If engine failure was caused by fuel exhaustion, power will not be regained after switching fuel tanks until the empty fuel lines are filled. This may require up to ten seconds.

If power is not regained, proceed with the Power Off Landing procedure (refer to the emergency checklist and paragraph 3.15).

**3.13 ENGINE POWER LOSS IN FLIGHT (3.5c)**

Complete engine power loss is usually caused by fuel flow interruption and power will be restored shortly after fuel flow is restored. If power loss occurs at a low altitude, the first step is to prepare for an emergency landing (refer to paragraph 3.15). An airspeed of at least 79 KIAS should be maintained.

If altitude permits, switch the fuel selector to another tank containing fuel and turn the electric fuel pump to ON. Move the mixture control to RICH and the alternate air to OPEN. Check the engine gauges for an indication of the cause of the power loss. If no fuel flow/pressure is indicated, check the tank selector position to be sure it is on a tank containing fuel.

When power is restored move the alternate air to the CLOSED position and turn OFF the electric fuel pump.

If the preceding steps do not restore power, prepare for an emergency landing.

If time permits, turn the ignition switch to L, then to R, then back to BOTH. Move the throttle and mixture control levers to different settings. This may restore power if the problem is too rich or too lean a mixture or if there is a partial fuel system restriction. Try the other fuel tank. Water in the fuel could take some time to be used up, and allowing the engine to windmill may restore power. If power loss is due to water, fuel flow/pressure indications will be normal.

**3.13 ENGINE POWER LOSS IN FLIGHT (3.5c) (continued)**

If engine failure was caused by fuel exhaustion power will not be restored after switching fuel tanks until the empty fuel lines are filled. This may require up to ten seconds.

If power is not regained, proceed with the Power Off Landing procedure (refer to emergency checklist and paragraph 3.15). Trim for 79 KIAS.

**3.15 POWER OFF LANDING (3.5d)**

If loss of power occurs at altitude, trim the aircraft for best gliding angle (79 KIAS, air conditioner off) and look for a suitable field. If measures taken to restore power are not effective, and if time permits, check your charts for airports in the immediate vicinity; it may be possible to land at one if you have sufficient altitude. At best gliding angle, with the engine windmilling, and the propeller control in full DECREASE rpm, the aircraft will travel approximately 1.6 miles for each thousand feet of altitude. If possible, notify the FAA by radio of your difficulty and intentions. If another pilot or passenger is aboard, let him help.

When you have located a suitable field, establish a spiral pattern around this field. Try to be at 1000 feet above the field at the downwind position, to make a normal landing approach. When the field can easily be reached, slow to 72 KIAS with flaps down for the shortest landing. Excess altitude may be lost by widening your pattern, using flaps or slipping, or a combination of these.

Whether to attempt a landing with gear up or down depends on many factors. If the field chosen is obviously smooth and firm, and long enough to bring the plane to a stop, the gear should be down. If there are stumps or rocks or other large obstacles in the field, the gear in the down position will better protect the occupants of the aircraft. If, however, the field is suspected to be excessively soft or short, or when landing in water of any depth, a wheels-up landing will normally be safer and do less damage to the airplane.

Touchdown should normally be made at the lowest possible airspeed.



**3.15 POWER OFF LANDING (3.5d) (continued)**

**3.15a Gear Down Emergency Landing (3.5d)**

When committed to a gear down emergency landing, select landing gear DOWN. Flaps may be used as desired. Close the throttle control and move the mixture control to idle cut-off. Shut OFF the ignition, battery master (BATT MASTR), and alternator (ALTR) switches. Turn the fuel selector valve to OFF. The seat belts and shoulder harness should be tightened. Touchdown should normally be made at the lowest possible airspeed.

**NOTE**

If the battery master switch is OFF, the landing gear cannot be retracted.

**3.15b Gear Up Emergency Landing (3.5d)**

When committed to a gear up landing, CLOSE the throttle, move the mixture to idle cut-off, and shut OFF the ignition, battery master (BATT MASTR), and alternator (ALTR) switches. Turn OFF the fuel selector valve. Seat belts and shoulder harness should be tightened. Touchdown should normally be made at the lowest possible airspeed with full flaps.

**3.17 FIRE IN FLIGHT (3.5e)**

The presence of fire is noted through smoke, smell and heat in the cabin. It is essential that the source of the fire be promptly identified through instrument readings, character of the smoke, or other indications since the action to be taken differs somewhat in each case.

Check for the source of the fire first.

If smoke in the cabin indicates an electrical fire, turn the battery master (BATT MASTR) and alternator (ALTR) switches OFF. The cabin vents should be opened and the cabin heat turned OFF. A landing should be made as soon as possible.

If an engine fire is present, switch the fuel selector to OFF and close the throttle. The mixture should be at idle cut-off. Turn the electric fuel pump OFF. In all cases, the heater and defroster should be OFF. If radio communication is not required select the battery master (BATT MASTR) and alternator (ALTR) switches OFF. If the terrain permits, a landing should be made immediately.

**NOTE**

The possibility of an engine fire in flight is extremely remote. The procedure given is general and pilot judgment should be the determining factor for action in such an emergency.

**3.19 LOSS OF OIL PRESSURE (3.5f)**

Loss of oil pressure may be either partial or complete. A partial loss of oil pressure usually indicates a malfunction in the oil pressure regulating system, and a landing should be made as soon as possible to investigate the cause and prevent engine damage.

A complete loss of oil pressure indication may signify oil exhaustion or may be the result of a faulty gauge. In either case, proceed toward the nearest airport, and be prepared for a forced landing. If the problem is not a pressure gauge malfunction, the engine may stop suddenly. Maintain altitude until such time as a dead stick landing can be accomplished. Don't change power settings unnecessarily, as this may hasten complete power loss.

**3.19 LOSS OF OIL PRESSURE (3.5f) (continued)**

Depending on the circumstances, it may be advisable to make an off airport landing while power is still available, particularly if other indications of actual oil pressure loss, such as sudden increases in temperatures, or oil smoke, are apparent, and an airport is not close.

If engine stoppage occurs, proceed with Power Off Landing.

**3.21 LOSS OF FUEL FLOW/PRESSURE (3.5g)**

The most probable cause of loss of fuel flow/pressure is either fuel depletion in the fuel tank selected, or failure of the engine driven fuel pump. If loss of fuel flow/pressure occurs, check that the fuel selector is on a tank containing fuel and turn ON the electric fuel pump.

If the problem is not an empty tank, land as soon as practical and have the engine driven fuel pump and fuel system checked.

**3.23 HIGH OIL TEMPERATURE (3.5h)**

An abnormally high oil temperature indication may be caused by a low oil level, an obstruction in the oil cooler, damaged or improper baffle seals, a defective gauge, or other causes. Land as soon as practical at an appropriate airport and have the cause investigated.

A steady, rapid rise in oil temperature is a sign of trouble. Land at the nearest airport and let a mechanic investigate the problem. Watch the oil pressure gauge for an accompanying loss of pressure.

**3.25 ELECTRICAL FAILURE (3.5i)**

Loss of alternator output is detected through zero reading on the ammeter. Before executing the following procedure, ensure that the reading is zero, and not merely low, by actuating an electrically powered device, such as the landing light. If no increase in the ammeter reading is noted, alternator failure can be assumed.

The electrical load should be reduced as much as possible. Check for an open alternator field circuit breaker.

Next, attempt to reset the overvoltage relay by moving the ALTR switch to OFF for one second and then to ON. If the trouble was caused by a momentary overvoltage condition (16.5 volts and up) this procedure should return the ammeter to a normal reading.

**3.25 ELECTRICAL FAILURE (3.5i) (continued)**

If the ammeter continues to indicate ZERO output, or if the alternator will not remain reset, turn off the ALTR switch, maintain minimum electrical load and land as soon as practical. All electrical load is being supplied by the battery.

**3.27 ELECTRICAL OVERLOAD (Alternator over 20 amps above known electrical load) (3.5j)**

An abnormally high alternator output may be caused by a low battery, battery fault, or other abnormal electrical load.

Should an abnormally high alternator output be observed, turn the BATT MASTR (battery master) switch OFF. If the ammeter reading does NOT decrease, turn the ALTR (alternator) switch OFF and land as soon as possible. The landing gear must be lowered using the Emergency Landing Gear Extension procedure (3.33).

If, after turning the BATT MASTR switch OFF, the ammeter reading DOES decrease, turn the BATT MASTR switch ON, and continue to monitor the ammeter. If the ammeter reading does not begin to decrease within five minutes, turn the BATT MASTR switch OFF and land as soon as possible.

**CAUTION**

If the battery is depleted, the landing gear must be lowered using the emergency extension procedure. The gear position lights will be inoperative.

**NOTE**

Due to increased system voltage and radio frequency noise, operation with ALTR switch ON and BATT MASTR switch OFF should be made only when required by an electrical system failure.

If the ammeter reading DOES begin to decrease within five minutes after the BATT MASTR switch is turned ON, proceed with flight while continuing to monitor ammeter.

**3.29 PROPELLER OVERSPEED (3.5k)**

Propeller overspeed is caused by a malfunction in the propeller governor or low oil pressure which allows the propeller blades to rotate to full low pitch.

If propeller overspeed should occur, retard the throttle and check the oil pressure. The propeller control should be moved to full DECREASE rpm and then set if any control is available. Airspeed should be reduced and throttle used to maintain 2700 rpm.

**3.31 EMERGENCY LANDING GEAR EXTENSION (3.5m)**

**NOTE**

Refer to paragraph 4.39 for differences when emergency gear extension is being performed for training purposes.

Prior to initiating the emergency extension procedure, check to ensure that the battery master (BATT MASTR) and alternator (ALTR) switches are ON, and that the circuit breakers have not opened. If it is in daytime, the NAV LIGHT switch should be turned OFF. Check the landing gear indicators for faulty bulbs.

If the landing gear does not check down and locked, reduce the airspeed below 87 KIAS. Move the landing gear selector switch to the DOWN position.

If the gear has still failed to lock down, move and *hold* the emergency gear lever down to the EMERGENCY DOWN position.

If the gear has still failed to lock down, yaw the airplane abruptly from side to side with the rudder.

If the nose gear will not lock down using the above procedure, slow the airplane to the lowest safe speed attainable using the lowest power setting required for safe operation. Move the landing gear selector switch to the gear DOWN position. If the landing gear does not check down, recycle the gear through the UP position and then select the DOWN position.

**3.33 SPIN RECOVERY (3.5n)**

Intentional spins are prohibited in this airplane. If a spin is inadvertently entered, immediately apply full rudder opposite to the direction of rotation. Move the control wheel full forward while neutralizing the ailerons. Move the throttle to IDLE. When the rotation stops, neutralize the rudder and ease back on the control wheel as required to smoothly regain a level flight attitude.

**3.35 OPEN DOOR (3.5o)**

The cabin door is double latched, so the chances of its springing open in flight at both the top and bottom are remote. However, should the upper latch be overlooked or the side latch not fully engaged, the door may spring partially open. This will usually happen at takeoff or soon afterward. A partially open door will not affect normal flight characteristics, and a normal landing can be made with the door open.

If both upper and side latches are open, the door will trail slightly open, and airspeed will be reduced slightly.

To close the door in flight, slow the airplane to 87 KIAS, close the cabin vents and open the storm window. If the top latch is open, latch it. If the side latch is open, pull on the armrest while moving the latch handle to the latched position. If both latches are open, close the side latch first, and then the top latch.

**3.37 ENGINE ROUGHNESS (3.5p)**

Engine roughness may be caused by dirt in the injector nozzles, induction system icing, or ignition problems.

First adjust the mixture for maximum smoothness. The engine will run rough if the mixture is too rich or too lean.

Move the alternate air to OPEN and then turn ON the electric fuel pump

Switch the fuel selector to another tank to see if fuel contamination is the problem.

Check the engine gauges for abnormal readings. If any gauge readings are abnormal proceed accordingly.

**3.37 ENGINE ROUGHNESS (3.5p) (Continued)**

The magneto switch should then be moved L, then R, then back to BOTH. If operation is satisfactory on either magneto, proceed on that magneto at reduced power with full RICH mixture to a landing at the first available airport.

If roughness persists, prepare for a precautionary landing at pilot's discretion.

**TABLE OF CONTENTS**  
**SECTION 4**  
**NORMAL PROCEDURES**

| Paragraph<br>No. |  | Page<br>No. |
|------------------|--|-------------|
| 4.1              | General.....   | 4-1         |
| 4.3              | Airspeeds for Safe Operations .....                      | 4-2         |
| 4.5              | Normal Procedures Checklist .....                        | 4-3         |
| 4.5a             | Preflight Checklist (4.9) .....                          | 4-3         |
| 4.5b             | Before Starting Engine Checklist (4.11) .....            | 4-6         |
| 4.5c             | Engine Start Checklist (4.13) .....                      | 4-7         |
|                  | ENGINE START - GENERAL.....                              | 4-7         |
|                  | NORMAL START - COLD ENGINE (4.13a).....                  | 4-7         |
|                  | NORMAL START - HOT ENGINE (4.13b) .....                  | 4-8         |
|                  | ENGINE START WHEN FLOODED (4.13c) .....                  | 4-8         |
|                  | ENGINE START WITH EXTERNAL<br>POWER SOURCE (4.13d) ..... | 4-8         |
| 4.5d             | Warm-Up Checklist (4.15) .....                           | 4-9         |
| 4.5e             | Taxiing Checklist (4.17) .....                           | 4-9         |
| 4.5f             | Ground Check Checklist (4.19).....                       | 4-9         |
| 4.5g             | Before Takeoff Checklist (4.21) .....                    | 4-10        |
| 4.5h             | Takeoff Checklist (4.23) .....                           | 4-11        |
|                  | NORMAL TECHNIQUE (4.23b).....                            | 4-11        |



**TABLE OF CONTENTS**  
**SECTION 4**  
**NORMAL PROCEDURES (cont)**

| Paragraph<br>No. |  | Page<br>No. |
|------------------|--|-------------|
| 4.5h             | Takeoff Checklist (4.23) (continued) .....                 |             |
|                  | SHORT FIELD, OBSTACLE CLEARANCE<br>TECHNIQUE (4.23b) ..... | 4-11        |
|                  | SOFT FIELD TECHNIQUE (4.23b) .....                         | 4-11        |
| 4.5i             | Climb Checklist (4.25) .....                               | 4-12        |
| 4.5j             | Cruise Checklist (4.27) .....                              | 4-12        |
| 4.5k             | Approach And Landing Checklist (4.29) .....                | 4-12        |
| 4.5m             | Stopping Engine Checklist (4.31) .....                     | 4-13        |
| 4.5n             | Mooring Checklist (4.33) .....                             | 4-13        |
| 4.7              | AMPLIFIED PROCEDURES .....                                 | 4-15        |
| 4.9              | PREFLIGHT CHECK (4.5a) .....                               | 4-15        |
| 4.9a             | Cockpit (4.5a) .....                                       | 4-15        |
| 4.9b             | Right Wing (4.5a) .....                                    | 4-15        |
| 4.9c             | Nose Section (4.5a) .....                                  | 4-16        |
| 4.9d             | Left Wing (4.5a) .....                                     | 4-17        |
| 4.9e             | Fuselage (4.5a) .....                                      | 4-17        |
| 4.10             | ENGINE START - GENERAL (4.5c) .....                        | 4-18        |
| 4.11             | BEFORE STARTING ENGINE (4.5b) .....                        | 4-18a       |
| 4.13             | ENGINE START (4.5c) .....                                  | 4-18a       |

**ISSUED: JULY 12, 1995**  
**REVISED: MAY 12, 2010**

**REPORT: VB-1612**  
**4-ii**

**TABLE OF CONTENTS**  
**SECTION 4**  
**NORMAL PROCEDURES (cont)**

| Paragraph<br>No. |   | Page<br>No. |
|------------------|---|-------------|
| 4.13a            | Normal Start - Cold Engine (4.5c) .....                                   | 4-18a       |
| 4.13b            | Normal Start - Hot Engine (4.5c) .....                                    | 4-19        |
| 4.13c            | Engine Start When Flooded (4.5c) .....                                    | 4-19        |
| 4.13d            | Engine Start With External Power Source (4.5c) .....                      | 4-19        |
| 4.15             | WARM-UP (4.5d) .....  | 4-20        |
| 4.17             | TAXIING (4.5e) .....  | 4-20        |
| 4.19             | GROUND CHECK (4.5f) .....   | 4-21        |
| 4.21             | BEFORE TAKEOFF (4.5g) .....   | 4-22        |
| 4.23             | TAKEOFF (4.5h) .....  | 4-22        |
| 4.23a            | Normal Technique (4.5h) .....   | 4-22        |
| 4.23b            | Short Field, Obstacle Clearance And<br>Soft Field Techniques (4.5h) ..... | 4-22        |
| 4.25             | CLIMB (4.5i) .....  | 4-23        |
| 4.27             | CRUISE(4.5j) .....  | 4-23        |
| 4.29             | APPROACH AND LANDING (4.5k) .....   | 4-25        |
| 4.31             | STOPPING ENGINE (4.5m) .....  | 4-25        |
| 4.33             | MOORING (4.5n) .....  | 4-26        |
| 4.37             | STALLS .....  | 4-26        |
| 4.37             | TURBULENT AIR OPERATION .....   | 4-27        |

**ISSUED: JULY 12, 1995**  
**REVISED: MAY 12, 2010**

**REPORT: VB-1612**  
**4-iii**

TABLE OF CONTENTS

SECTION 4

NORMAL PROCEDURES (cont)

| Paragraph<br>No. |                          | Page<br>No. |
|------------------|--------------------------|-------------|
| 4.39             | LANDING GEAR .....       | 4-27        |
| 4.41             | WEIGHT AND BALANCE ..... | 4-28        |
| 4.43             | NOISE LEVEL .....        | 4-28        |

**SECTION 4  
NORMAL PROCEDURES**

**4.1 GENERAL**

This section provides the normal operating procedures for the PA-28R-201, Arrow airplane. All of the normal operating procedures required by the FAA, as well as those procedures which have been determined as necessary for the operation of the airplane, as determined by the operating and designed features of the airplane, are presented.

Normal operating procedures associated with optional systems and equipment which require handbook supplements are presented in Section 9, Supplements.

These procedures are provided to supply information on procedures which are not the same for all airplanes and as a source of reference and review. Pilots should familiarize themselves with these procedures to become proficient in the normal operation of the airplane.

This section is divided into two parts. The first part is a short form checklist supplying an action - reaction sequence for normal procedures with little emphasis on the operation of the systems. Numbers in parentheses after each checklist section indicate the paragraph where the corresponding amplified procedure can be found.

The second part of this section contains the amplified normal procedures which provide detailed information and explanations of the procedures and how to perform them. This portion of the section is not intended for use as an inflight reference due to the lengthy explanation. The short form checklists should be used on the ground and in flight. Numbers in parentheses after each paragraph title indicate where the corresponding checklist can be found.

**4.3 AIRSPEEDS FOR SAFE OPERATIONS**

The following airspeeds are those which are significant to the safe operation of the airplane. These figures are for standard airplanes flown at gross weight under standard conditions at sea level.

Performance for a specific airplane may vary from published figures depending upon the equipment installed, the condition of the engine, airplane and equipment, atmospheric conditions and piloting technique.

- (a) Best Rate of Climb Speed
  - gear up, flaps up 90 KIAS
  - gear down, flaps up 78 KIAS
- (b) Best Angle of Climb Speed
  - gear up, flaps up 78 KIAS
  - gear down, flaps up 72 KIAS
- (c) Turbulent Air Operating Speed (See Subsection 2.3) 118 KIAS
- (d) Maximum Flap Speed 103 KIAS
- (e) Landing Final Approach Speed (Flaps 40°) 75 KIAS
- (f) Maximum Demonstrated Crosswind Velocity 17 KTS

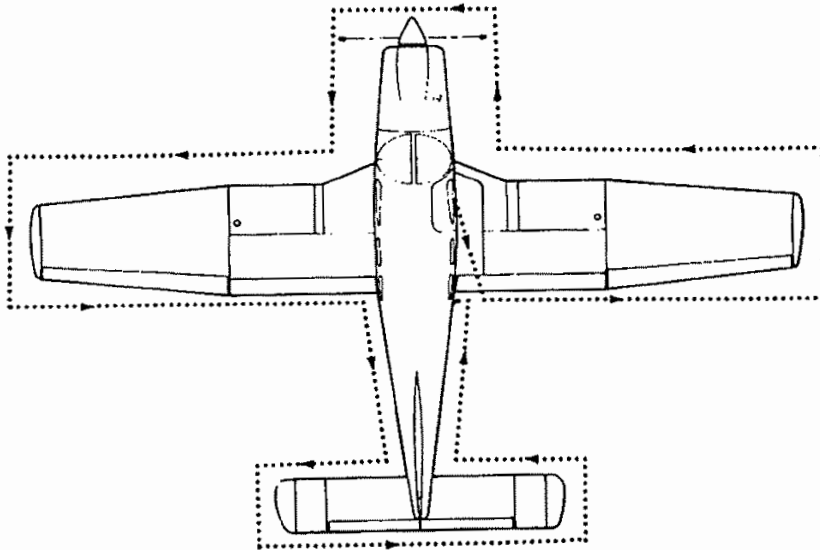

**WALK-AROUND**

Figure 4-1

**4.5 NORMAL PROCEDURES CHECKLIST**

**4.5a Preflight Checklist (4.9)**

*CAUTION*

The flap position should be noted before boarding the airplane. The flaps must be placed in the UP position before they will lock and support weight on the step.

**COCKPIT (4.9a)**

- Control Wheel.....release restraints
- Gear Handle .....DOWN
- Parking Brake .....SET
- Avionics.....OFF
- All Switches .....OFF
- Mixture.....IDLE CUT-OFF
- Magneto Switch .....OFF
- BATT MASTR Switch.....ON

**4.5a Preflight Checklist (4.9) (continued)**

**COCKPIT (4.9a) (continued)**

Fuel Gauges .....check QUANTITY  
Annunciator Panel.....CHECK  
BATT MASTR Switch .....OFF  
Primary Flight Controls.....PROPER OPERATION  
Flaps .....PROPER OPERATION  
Trim.....NEUTRAL  
Pitot and Static Systems.....DRAIN  
Windows .....check CLEAN  
Required Papers and POH .....check ON BOARD  
Tow Bar and Baggage .....STOW PROPERLY - SECURE  
Baggage Door .....CLOSE and SECURE

**RIGHT WING (4.9b)**

Surface Condition .....CLEAR of ICE, FROST, SNOW  
Flap and Hinges .....CHECK  
Aileron and Hinges .....CHECK  
Static Wicks.....CHECK - SECURE  
Wing Tip and Lights .....CHECK  
Fuel Tank.....CHECK supply  
visually - SECURE cap  
Fuel Tank Vent.....CLEAR

**CAUTION**

When draining any amount of fuel, care should be taken to ensure that no fire hazard exists before starting engine.

Fuel Tank Sump.....DRAIN and CHECK  
for water, sediment,  
and proper fuel  
Tie Down and Chock .....REMOVE  
Main Gear Strut .....PROPER INFLATION  
(2.0 +/- 0.25 in.)  
Tire .....CHECK  
Brake Block and Disc .....CHECK  
Fresh Air Inlet .....CLEAR

4.5a Preflight Checklist (continued)

**NOSE SECTION (4.9c)**

|                            |   |
|----------------------------|---|
| General Condition.....     | CHECK                                   |
| Cowling.....               | SECURE                                  |
| Oil.....                   | CHECK QUANTITY                          |
| Dipstick.....              | PROPERLY SEATED                         |
| Oil Filler Cap.....        | SECURE                                  |
| Engine Baffle Seals.....   | CHECK                                   |
| Windshield.....            | CLEAN                                   |
| Propeller and Spinner..... | CHECK                                   |
| Air Inlets.....            | CLEAR                                   |
| Alternator Belt.....       | CHECK TENSION                           |
| Landing Light.....         | CHECK                                   |
| Chock.....                 | REMOVE                                  |
| Nose Gear Strut.....       | PROPER INFLATION<br>(2.75 +/- 0.25 in.) |
| Nose Wheel Tire.....       | CHECK                                   |

*CAUTION*

When draining any amount of fuel, care should be taken to ensure that no fire hazard exists before starting engine.

|                    |       |
|--------------------|-------|
| Fuel Strainer..... | DRAIN |
|--------------------|-------|

**LEFT WING (4.9d)**

|                           |  |
|---------------------------|--|
| Surface Condition.....    | CLEAR of ICE, FROST, SNOW              |
| Stall Warning Vane.....   | CHECK                                  |
| Fuel Tank.....            | CHECK Supply<br>visually - SECURE CAP  |
| Fresh Air Inlet.....      | CLEAR                                  |
| Chock.....                | REMOVE                                 |
| Main Gear Strut.....      | PROPER INFLATION<br>(2.0 +/- 0.25 in.) |
| Tire.....                 | CHECK                                  |
| Brake Block and Disc..... | CHECK                                  |
| Fuel Tank Vent.....       | CLEAR                                  |

*CAUTION*

When draining any amount of fuel, care should be taken to ensure that no fire hazard exists before starting engine.



**4.5a Preflight Checklist (continued)**

**LEFT WING (4.9d) (continued)**

Fuel Tank Sump.....DRAIN and CHECK  
for water, sediment,  
and proper fuel  
Tie Down.....REMOVE  
Pitot Mast.....REMOVE COVER  
- HOLE CLEAR  
Wing Tip and Lights .....CHECK  
Aileron and Hinges .....CHECK  
Flap and Hinges .....CHECK  
Static Wicks.....CHECK - SECURE

**FUSELAGE (4.9e)**

Antennas .....CHECK  
Left Static Vent.....CLEAR  
Fresh Air Inlet .....CLEAR  
Empennage .....CLEAR of ICE,  
FROST, SNOW  
Stabilator and Trim Tab .....CHECK  
Tie Down.....REMOVE  
Right Static Vent.....CLEAR  
BATT MASTR Switch.....ON  
Cockpit Lighting .....CHECK  
Navigation and Strobe Lights .....CHECK  
Landing Light.....CHECK  
Stall Warning.....CHECK  
Pitot Heat .....CHECK  
All Switches .....OFF  
BATT MASTR Switch.....OFF  
Passengers.....BOARD  
Cabin Door.....CLOSE and SECURE  
Seat Belts and Harness.....FASTEN - CHECK  
inertia reel

**4.5b Before Starting Engine Checklist (4.11)**

**BEFORE STARTING ENGINE (4.11)**

Brakes .....SET  
Circuit Breakers.....IN  
Alternate Air.....OFF  
Propeller .....FULL INCREASE RPM  
Avionics.....OFF  
Fuel Selector .....DESIRED TANK



4.5c Engine Start Checklist (4.13) (continued)

**NORMAL START - HOT ENGINE (4.13b)**

Throttle.....1/2 INCH OPEN  
ALTR Switch .....ON  
BATT MASTR Switch .....ON  
Electric Fuel Pump .....ON  
Mixture.....IDLE CUT-OFF  
Propeller .....CLEAR  
Starter.....ENGAGE  
Mixture. ....ADVANCE  
Throttle. ....ADJUST  
Oil Pressure.....CHECK

**ENGINE START WHEN FLOODED (4.13c)**

Throttle.....FULL OPEN  
ALTR Switch .....ON  
BATT MASTR Switch.....ON  
Electric Fuel Pump.....OFF  
Mixture.....IDLE CUT-OFF  
Propeller .....CLEAR  
Starter.....ENGAGE  
Mixture. ....ADVANCE  
Throttle.....RETARD  
Oil Pressure.....CHECK

**ENGINE START WITH EXTERNAL POWER SOURCE (4.13d)**

BATT MASTR Switch .....OFF  
ALTR Switch.....OFF  
All Electrical Equipment.....OFF  
Terminals .....CONNECT  
External Power Plug .....INSERT in receptacle

Proceed with normal start.

Throttle .....LOWEST POSSIBLE RPM  
External Power Plug .....REMOVE from receptacle  
BATT MASTR Switch.....ON  
ALTR Switch .....ON - CHECK AMMETER  
Oil Pressure.....CHECK

4.5c Engine Start Checklist (4.13) (continued)

ENGINE START WITH EXTERNAL POWER SOURCE (4.13d)  
(continued)

CAUTION

It is possible to use the ship's battery in parallel by turning only the battery master switch ON. This will give longer cranking capabilities, but will not increase the amperage. Care should be exercised because if the ship's battery has been depleted, the external power supply can be reduced to the level of the ship's battery. This can be tested by turning only the battery master switch ON momentarily while the starter is engaged. If cranking speed increases, the ship's battery is at a higher level than the external power supply.

NOTE

For all normal operations using the PEP jumper cables, the battery master and alternator switches should be OFF.

4.5d Warm-Up Checklist (4.15)

WARM-UP (4.15)

Throttle.....1400 to 1500 RPM

4.5e Taxiing Checklist (4.17)

TAXIING (4.17)

Taxi Area .....CLEAR  
Parking Brake.....RELEASE  
Propeller .....HIGH RPM  
Throttle.....APPLY SLOWLY  
Brakes .....CHECK  
Steering .....CHECK

4.5f Ground Check Checklist (4.19)

GROUND CHECK (4.19)

Parking Brake .....SET  
Propeller.....FULL INCREASE  
Throttle.....2000 RPM

4.5f Ground Check Checklist (4.19) (continued)

**GROUND CHECK (4.19) (continued)**

Magnetos.....CHECK  
max. drop 175 RPM  
- max. diff. 50 RPM  
Vacuum.....4.8 to 5.1 inches Hg  
Oil Temperature .....CHECK  
Oil Pressure.....CHECK  
Ammeter .....CHECK  
Annunciator Panel .....PRESS-TO-TEST  
Propeller .....EXERCISE - then  
FULL INCREASE  
Alternate Air .....CHECK  
Engine is warm for takeoff when throttle can be opened without engine  
faltering.  
Electric Fuel Pump.....OFF  
Fuel Pressure.....CHECK  
Throttle.....RETARD

4.5g Before Takeoff Checklist (4.21)

**BEFORE TAKEOFF (4.21)**

BATT MASTR Switch.....ON  
ALTR Switch .....ON  
Flight Instruments .....CHECK  
Fuel Selector .....PROPER TANK  
Electric Fuel Pump .....ON  
Engine Gauges .....CHECK  
Alternate Air .....CLOSED  
Seat Backs.....ERECT  
Mixture .....SET  
Propeller .....SET  
Belts/Harness .....FASTENED/CHECK  
Empty Seats.....SEAT BELTS  
SNUGLY FASTENED  
Flaps .....SET  
Trim .....SET  
Controls.....FREE  
Doors .....LATCHED  
Air Conditioner .....OFF

4.5h Takeoff Checklist (4.23)

**NORMAL TECHNIQUE (4.23a)**

- Flaps .....SET
- Trim .....SET
- Accelerate to 65 to 75 KIAS.
- Control Wheel.....back pressure to ROTATE  
smoothly to CLIMB ATTITUDE

**SHORT FIELD, OBSTACLE CLEARANCE TECHNIQUE (4.23b)**

- Flaps.....25° (second notch)
- Accelerate to 50 to 60 KIAS depending on aircraft weight.
- Control Wheel.....back pressure to ROTATE  
to CLIMB ATTITUDE
- After breaking ground, accelerate to 55 to 65 KIAS depending on  
aircraft weight.
- Gear .....UP
- Accelerate to best gear up angle of climb speed - 78 KIAS, slowly  
retract the flaps and climb past the obstacle.
- Accelerate to best gear up rate of climb speed - 90 KIAS.

**SOFT FIELD TECHNIQUE (4.23b)**

- Flaps.....25° (second notch)
- Accelerate to 50 to 60 KIAS depending on aircraft weight.
- Control Wheel.....back pressure to ROTATE  
to CLIMB ATTITUDE
- After breaking ground, accelerate to 55 to 65 KIAS depending on  
aircraft weight.
- Gear .....UP
- Accelerate to best gear up rate of climb speed - 90 KIAS.
- Flaps .....RETRACT SLOWLY

**4.5i Climb Checklist (4.25)**

**CLIMB (4.25)**

Best Rate (2750 lb.) (Gear Up,  
Flaps Up).....90 KIAS  
Best Rate (2750 lb.) (Gear Down,  
Flaps Up).....78 KIAS  
Best Angle (2750 lb.) (Gear Up,  
Flaps Up).....78 KIAS  
Best Angle (2750 lb.) (Gear Down,  
Flaps Up).....72 KIAS  
En Route.....104 KIAS  
Electric Fuel Pump .....OFF at desired  
altitude

**4.5j Cruise Checklist (4.27)**

**CRUISE (4.27)**

Reference performance charts, Avco-Lycoming Operator's Manual  
and power setting table.

Normal Maximum Power.....75%  
Power .....SET per power table  
Mixture .....ADJUST

**4.5k Approach And Landing Checklist (4.29)**

**APPROACH AND LANDING (4.29)**

Fuel Selector .....PROPER TANK  
Seat Backs .....ERECT  
Belts/Harness .....FASTEN  
Electric Fuel Pump .....ON  
Mixture .....SET  
Propeller .....FULL INCREASE  
Gear .....DOWN - 129 KIAS max  
Flaps .....SET - 103 KIAS max  
Air Conditioner .....OFF  
Trim to 75 KIAS

**4.5m Stopping Engine Checklist (4.31)**

**STOPPING ENGINE (4.31)**

*CAUTION*

The flaps must be placed in the UP position for the flap step to support weight. Passengers should be cautioned accordingly.

- Flaps .....RETRACT
- Electric Fuel Pump.....OFF
- Air Conditioner .....OFF
- Avionics.....OFF
- Electrical Switches .....OFF
- Propeller.....FULL INCREASE
- Throttle.....CLOSED
- Mixture.....IDLE CUT-OFF
- Magnetos .....OFF
- ALTR Switch.....OFF
- BATT MASTR Switch .....OFF

**4.5n Mooring Checklist (4.33)**

**MOORING (4.33)**

- Parking Brake .....SET
- Flaps .....FULL UP
- Control Wheel.....SECURED with belts
- Wheel Chocks .....IN PLACE
- Tie Downs .....SECURE



**THIS PAGE INTENTIONALLY LEFT BLANK**

#### 4.7 AMPLIFIED NORMAL PROCEDURES (GENERAL)

The following paragraphs are provided to supply detailed information and explanations of the normal procedures necessary for the safe operation of the airplane.

#### 4.9 PREFLIGHT CHECK (4.5a)

The airplane should be given a thorough preflight and walk-around check. The preflight should include a check of the airplane's operational status, computation of weight and C.G. limits, takeoff and landing distances, and in-flight performance. A weather briefing should be obtained for the intended flight path, and any other factors relating to a safe flight should be checked before takeoff.

##### 4.9a Cockpit (4.5a)

#### CAUTION

The flap position should be noted before boarding the airplane. The flaps must be placed in the UP position before they will lock and support weight on the step.

Upon entering the cockpit, release the seat belts securing the control wheel. Check that the landing gear selector handle is in the DOWN position and set the parking brake. Ensure that all avionics and electrical switches are OFF. Check that the mixture is in the idle cut-off and the magneto switch is OFF. Turn ON the battery master (BATT MASTR) switch; check the fuel quantity gauges for adequate supply and check that the annunciator panel illuminates. Turn OFF the battery master (BATT MASTR) switch. Check the primary flight controls and flaps for proper operation and set the trim to neutral. Open the pitot and static drains to remove any moisture that has accumulated in the lines. Check the windows for cleanliness and that the required papers and POH are on board. Properly stow the tow bar and baggage and secure. Close and secure the baggage door.

##### 4.9b Right Wing (4.5a)

Begin the walk-around at the trailing edge of the right wing by checking that the wing surface and control surfaces are clear of ice frost, snow or other extraneous substances. Check the flap, aileron and hinges for damage and operational interference. Static wicks should be firmly attached and in good condition. Check the wing tip and lights for damage.

**4.9 PREFLIGHT CHECK (4.5a) (continued)**

**4.9b Right Wing (4.5a) (continued)**

Open the fuel cap and visually check the fuel color. The quantity should match the indication that was on the fuel quantity gauge. Replace cap securely. The fuel tank vent should be clear of obstructions.

**CAUTION**

When draining any amount of fuel, care should be taken to ensure that no fire hazard exists before starting engine.

Drain a fuel sample from the fuel tank into a container, through the quick drain located at the lower inboard rear corner of the tank. Make sure that enough fuel has been drained to ensure that all water and sediment is removed; check for proper fuel. The fuel system should be drained daily prior to the first flight and after each refueling.

Remove the tie down and chock.

Next, a complete check of the landing gear. Check the gear strut for proper inflation, there should be 2.0 +/- 0.25 inches of strut exposure under a normal static load. Check the tire for cuts, wear, and proper inflation. Make a visual check of the brake block and disc.

Check that the fresh air inlet is clear of foreign matter.

**4.9c Nose Section (4.5a)**

Check the general condition of the nose section and check for oil or fluid leakage and that the cowling is secure. Check the oil level; make sure that the dipstick has been properly seated and the oil cap properly secured. Check the engine baffle seals. Check the windshield and clean if necessary. The propeller and spinner should be checked for detrimental nicks, cracks, or other defects. The air inlets should be clear of obstructions and check the alternator belt for proper tension. The landing light should be clean and intact.

Remove the chock and check the nose gear strut for proper inflation; there should be 2.75 +/- 0.25 inches of strut exposure under a normal static load. Check the tire for cuts, wear, and proper inflation.

**4.9 PREFLIGHT CHECK (4.5a) (continued)****4.9c Nose Section (4.5a) (continued)****CAUTION**

When draining any amount of fuel, care should be taken to ensure that no fire hazard exists before starting engine.

Open the fuel strainer located on the left side of the firewall long enough to remove any accumulation of water and sediment.

**4.9d Left Wing (4.5a)**

The wing surface should be clear of ice, frost, snow, or other extraneous substances. Check the stall warning vane for condition and freedom of movement. Open the fuel cap and visually check the fuel color. The quantity should match the indication that was on the fuel quantity gauge. Replace fuel cap securely. Check that the fresh air inlet is clear of foreign matter and remove the chock.

Check the main gear strut for proper inflation; there should be 2.0 +/- 0.25 inches of strut exposure under a normal static load. Check the tire for cuts, wear, and proper inflation. Make a visual check of the brake block and disc.

**CAUTION**

When draining any amount of fuel, care should be taken to ensure that no fire hazard exists before starting engine.

The fuel tank vent should be clear of obstructions. Drain enough fuel into a container to ensure that all water and sediment has been removed; check for proper fuel.

Remove tie down and remove the cover from the pitot mast on the underside of the wing. Make sure the hole is open and clear of obstructions. Check the wing tip and lights for damage. Check the aileron, flap, and hinges for damage and operational interference and that the static wicks are firmly attached and in good condition.

**4.9e Fuselage (4.5a)**

Check the condition and security of the antennas and that the ports in the left side static pad are clear. The empennage should be clear of ice, frost, snow, or other extraneous substances. Check that the fresh air inlet on the left side of the fuselage is clear. Check the stabilator and trim tab for damage and operational interference; the trim tab should move in the same direction as the stabilator. Remove the tie down. Check that the ports in the right side static pad are clear.

**4.9 PREFLIGHT CHECK (4.5a) (continued)**

**4.9e Fuselage (4.5a) (continued)**

Upon returning to the cockpit, an operational check of the interior lights, exterior lights, stall warning system, and pitot heat should now be made. Turn the battery master switch and other appropriate switches ON. Check the panel lighting and the overhead flood light. Visually confirm that exterior lights are operational. Lift the stall detector on the leading edge of the left wing and determine that the warning horn is activated. With the pitot heat switch ON the pitot head will be hot to the touch. After these checks are complete, the battery master (BATT MASTR) switch and all electrical switches should be turned OFF.

Board the passengers and close and secure the cabin door. Fasten the seat belts and shoulder harness and check the function of the inertia reel by pulling sharply on the strap. Fasten seat belts on empty seats.

#### 4.10 ENGINE START - GENERAL

*CAUTION:*

Do not attempt flight if there is no indication of alternator output.

*CAUTION:*

If a positive oil pressure is not indicated within 30 seconds following an engine start, stop the engine and determine the trouble. In cold weather it will take a few seconds longer to get a positive oil pressure indication.

*NOTE:*

Starter manufacturer recommends starter cranking periods be limited to 10 seconds with a 20 second rest period between cranking attempts. Maximum of 6 start periods allowed. If start is not achieved on sixth attempt allow starter to cool for 30 minutes before attempting additional starts.

#### 4.11 BEFORE STARTING ENGINE (4.5b)

Before starting the engine, set the parking brake ON. Check that all circuit breakers are in and that the alternate air is OFF. Move the propeller control to the full INCREASE rpm position. Ensure that all avionics switches are OFF. Set the fuel selector to the desired tank.

#### 4.13 ENGINE START (4.5c)

##### 4.13a Normal Start - Cold Engine (4.5c)

Open the throttle lever approximately 1/2 inch. Turn ON the alternator and battery master switches, and the electric fuel pump. Move the mixture control to full RICH until an indication is noted on the fuel flow meter. The engine is now primed.

Move the mixture control to idle cut-off, check that the propeller area is clear, and engage the starter by rotating the magneto switch clockwise. When the engine fires, release the magneto switch, advance the mixture control to full RICH and move the throttle to the desired setting. Check the oil pressure.

If the engine does not fire within five to ten seconds, disengage the starter and reprime.

**ISSUED: JULY 12, 1995**  
**REVISED: MAY 12, 2010**

**REPORT: VB-1612**  
**4-18a**

**THIS PAGE INTENTIONALLY LEFT BLANK**

**4.13 ENGINE START (4.5c) (continued)****4.13b Normal Start - Hot Engine (4.5c)**

Open the throttle approximately 1/2 inch. Turn ON the alternator and battery master switches, and the electric fuel pump. The mixture control lever should be in idle cut-off. Check that the propeller area is clear, and engage the starter by rotating the magneto switch clockwise. When the engine fires, release the magneto switch, advance the mixture, and move the throttle to the desired setting. Check the oil pressure.

**4.13c Engine Start When Flooded (4.5c)**

The throttle lever should be full OPEN. Turn ON the alternator and battery master switches, and turn OFF the emergency fuel pump. The mixture control lever should be in idle cut-off. Check that the propeller area is clear, and engage the starter by rotating the magneto switch clockwise. When the engine fires, release the magneto switch, advance the mixture, and retard the throttle. Check the oil pressure.

**4.13d Engine Start With External Power Source (4.5c)**

An optional feature called the Piper External Power (PEP) allows the operator to use an external battery to crank the engine without having to gain access to the airplane's battery.

Turn OFF the alternator switch, the battery master switch, and all electrical equipment. Connect the RED lead of the PEP kit jumper cable to the POSITIVE (+) terminal of an external 12-volt battery and the BLACK lead to the NEGATIVE (-) terminal. Insert the plug of the jumper cable into the socket located on the fuselage. Note that when the plug is inserted, the electrical system is ON. Proceed with the normal starting technique.

After the engine has started, reduce power to the lowest possible rpm and disconnect the jumper cable from the aircraft. Turn the alternator and battery master switches ON. Check the alternator ammeter for an indication of output. **DO NOT ATTEMPT FLIGHT IF THERE IS NO INDICATION OF ALTERNATOR OUTPUT.**

**CAUTION**

It is possible to use the ship's battery in parallel by turning only the battery master switch ON. This will give longer cranking capabilities, but will not increase the amperage. Care should be exercised because if the ship's battery has been depleted, the external power supply can be reduced to the level of the ship's battery. This can be tested by turning only the battery master switch ON momentarily while the starter is engaged. If cranking speed increases, the ship's battery is at a higher level than the external power supply.



**4.13 ENGINE START (4.5c) (continued)**

**4.13d Engine Start With External Power Source (4.5c) (continued)**

**NOTE**

For all normal operations using the PEP jumper cables, the battery master and alternator switches should be OFF.

When the engine is firing evenly, advance the throttle to 800 rpm. If oil pressure is not indicated within thirty seconds, stop the engine and determine the trouble. In cold weather, it will take a few seconds longer to get an oil pressure indication. If the engine has failed to start, refer to the Lycoming Operating Handbook, Engine Troubles and Their Remedies.

Starter manufacturer recommends starter cranking periods be limited to 10 seconds with a 20 second rest period between cranking attempts. Maximum of 6 start periods allowed. If start is not achieved on sixth attempt allow starter to cool for 30 minutes before attempting additional starts.

**4.15 WARM-UP (4.5d)**

Warm-up the engine at 1400 to 1500 rpm. Avoid prolonged idling at low rpm, as this practice may result in fouled spark plugs.

Takeoff may be made as soon as the ground check is completed, provided that the throttle may be opened without backfiring or skipping, and without a reduction in engine oil pressure.

Do not operate the engine at high rpm when running up or taxiing over ground containing loose stones, gravel or any loose material that may cause damage to the propeller blades.

**4.17 TAXIING (4.5e)**

Before attempting to taxi the airplane, ground personnel should be instructed and approved by a qualified person authorized by the owner. Ascertain that the propeller back blast and taxi areas are clear.

Release the parking brake and apply power slowly to start the taxi roll. Taxi a few feet forward and apply the brakes to determine their effectiveness. Taxi with the propeller set in low pitch, high rpm setting. While taxiing, make slight turns to ascertain the effectiveness of the steering.

**4.17 TAXIING (4.5e) (continued)**

Observe wing clearances when taxiing near buildings or other stationary objects. If possible, station an observer outside the airplane.

Avoid holes and ruts when taxiing over uneven ground.

Do not operate the engine at high rpm when running up or taxiing over ground containing loose stones, gravel or any loose material that may cause damage to the propeller blades.

**4.19 GROUND CHECK (4.5f)**

Set the parking brake and check that the propeller control is set at high rpm. Advance the throttle to 2000 rpm for checking the magnetos. Drop off on either magneto should not exceed 175 rpm and the difference between the magnetos should not exceed 50 rpm. Operation on one magneto should not exceed 10 seconds.

Check the vacuum gauge; the indicator should read between 4.8 and 5.1 inches Hg at 2000 rpm. Retard the throttle. Check both oil temperature and oil pressure. The temperature may be low for some time if the engine is being run for the first time of the day. The engine is warm enough for takeoff when the throttle can be opened without the engine faltering. Check the ammeter for proper alternator output.

Check the annunciator panel lights with the press-to-test button. Also check the alternate air.

The propeller control should be moved through its complete range to check for proper operation, and then placed in full INCREASE rpm for takeoff. To obtain maximum rpm, push the pedestal mounted control fully forward on the instrument panel. Do not allow a drop of more than 500 rpm during this check. In cold weather the propeller control should be cycled from high to low rpm at least three times before takeoff to make sure that warm engine oil has circulated.

Turn the electric fuel pump OFF after starting or during warm-up and check the fuel flow/pressure gauge to make sure that the engine driven pump is operating. Prior to takeoff, the electric pump should be turned ON again to prevent loss of power during takeoff should the engine driven pump fail.

**4.21 BEFORE TAKEOFF (4.5g)**

After all aspects of the takeoff are considered, a before takeoff check procedure must be performed.

Verify that the battery master and alternator switches are ON. Check and set all of the night instruments as required. Check the fuel selector to make sure it is on the proper tank (fullest). Turn ON the electric fuel pump. Check the engine gauges. The alternate air should be in the CLOSED position.

All seat backs should be erect.

The mixture and propeller control levers should be set and the seat belts and shoulder harness fastened. Fasten the seat belts snugly around the empty seats.

Exercise and set the flaps and trim. Ensure proper movement and response of all night controls.

All doors should be properly secured and latched.

On air conditioned models, the air conditioner must be OFF to ensure normal takeoff performance.

**4.23 TAKEOFF (4.5h)**

**4.23a Normal Technique (4.5h)**

The normal takeoff technique is conventional for the Arrow. Flaps should be up and the trim should be set slightly aft of neutral, with the exact setting determined by the loading of the airplane. Allow the airplane to accelerate to 65 to 75 KIAS, depending on the weight of the aircraft, and ease back on the control wheel to rotate to climb attitude.

**4.23b Short Field, Obstacle Clearance And Soft Field Techniques (4.5h)**

The procedure used for a short field takeoff with an obstacle clearance or a soft field takeoff differs slightly from the normal technique. The flaps should be lowered to 25° (second notch). Allow the aircraft to accelerate to 50 to 60 KIAS depending on the aircraft weight and rotate the aircraft to climb attitude. After breaking ground, accelerate to 55 to 65 KIAS, depending on aircraft weight and select gear up. Continue to climb while accelerating to the gear up rate of climb speed, 90 KIAS if no obstacle is present or 78 KIAS if obstacle clearance is a consideration. Slowly retract the flaps one notch at a time while climbing out.

**4.25 CLIMB (4.5i)**

On climb-out after takeoff, it is recommended that the best angle of climb speed (78 KIAS) be maintained only if obstacle clearance is a consideration. The best rate of climb speed (90 KIAS) should be maintained with full power on the engine until adequate terrain clearance is obtained. At lighter than gross weight these speeds are reduced somewhat. An en route climb speed of 104 KIAS or higher is also recommended. This increased climb speed provides better engine cooling, less engine wear, reduced fuel consumption, lower cabin noise level, and better forward visibility.

When reaching the desired altitude, the electric fuel pump may be turned OFF.

To obtain the performance presented in the Performance Section of this handbook, full power (full throttle and 2700 rpm) must be used.

**4.27 CRUISE (4.5j)**

Following level-off for cruise, the airplane should be trimmed.

The cruising speed of the Arrow is determined by many factors, including power setting, altitude, temperature, loading and equipment installed in the airplane.

The normal maximum cruising power is 75% of the rated horsepower of the engine. When selecting cruising rpm below 2400, limiting manifold pressure for continuous operation, as specified by the appropriate Avco-Lycoming Operator's Manual, should be observed.

To obtain the desired power, set the manifold pressure and rpm according to the power setting table in this manual.

Use of the mixture control in cruising flight reduces fuel consumption significantly, especially at higher altitudes. The mixture should be leaned during cruising operation when 75% power or less is being used. If any doubt exists as to the amount of power being used, the mixture should be in the full RICH position for all operations.

**4.27 CRUISE (4.5j) (Continued)**

To lean the mixture, disengage the lock and pull the mixture control until the engine becomes rough, indicating that the lean mixture limit has been reached in the leaner cylinders. Then enrich the mixture by pushing the control towards the instrument panel until engine operation becomes smooth. The fuel flow meter will give a close approximation of the fuel being consumed. The low side of the power setting, as shown on the fuel flow meter, indicates best economy for that percent of power while the high side indicates best power.

If the airplane is equipped with the optional exhaust gas temperature (EGT) gauge, a more accurate means of leaning is available to the pilot. For this procedure, refer to the Avco-Lycoming Operator's Manual.

The pilot should monitor weather conditions while flying and should be alert to conditions which might lead to icing. If induction system icing is expected, place the alternate air control in the ON position.

During flight, keep account of time and fuel used in connection with power settings to determine how the fuel flow and fuel quantity gauging systems are operating. If the fuel flow indication is considerably higher than the fuel actually being consumed, a fuel nozzle may be clogged and require cleaning.

There are no mechanical uplocks in the landing gear system. In the event of a hydraulic system malfunction, the landing gear will free fall to the gear down position. The true airspeed with gear down is approximately 75% of the gear retracted airspeed for any given power setting. Allowances for the reduction in airspeed and range should be made when planning extended flight between remote airfields or flight over water.

In order to keep the airplane in best lateral trim during cruise flight, the fuel should be used alternately from each tank at one hour intervals.

Always remember that the electric fuel pump should be turned ON before switching tanks, and should be left on for a short period thereafter. To preclude making a hasty selection, and to provide continuity of flow, the selector should be changed to another tank before fuel is exhausted from the tank in use. The electric fuel pump should be normally OFF so that any malfunction of the engine driven fuel pump is immediately apparent. If signs of fuel starvation should occur at any time during flight, fuel exhaustion should be suspected, at which time the fuel selector should be immediately positioned to a full tank and the electric fuel pump switched to the ON position.

**4.29 APPROACH AND LANDING (4.5k)**

Check to ensure the fuel selector is on the proper (fullest) tank and that the seat backs are erect. The seat belts and shoulder harness should be fastened and the inertia reel checked.

Turn ON the electric fuel pump. The mixture should be set in the full RICH position. Set the propeller at full INCREASE rpm to facilitate ample power for an emergency go-around.

The landing gear may be extended at speeds below 129 KIAS. The airplane should be trimmed to a final approach speed of about 75 KIAS with flaps extended. The flaps can be lowered at speeds up to 103 KIAS, if desired. Turn OFF the air conditioner.

The mixture control should be kept in full RICH position to ensure maximum acceleration if it should be necessary to open the throttle again.

The amount of flap used during landings and the speed of the aircraft at contact with the runway should be varied according to the landing surface and conditions of wind and airplane loading. It is generally good practice to contact the ground at the minimum possible safe speed consistent with existing conditions.

Normally, the best technique for short and slow landings is to use full flap and enough power to maintain the desired airspeed and approach flight path. Mixture should be full RICH, fuel on the fullest tank, and the electric fuel pump ON. Reduce the speed during the flareout and contact the ground close to the stalling speed. After ground contact, hold the nose wheel off as long as possible. As the airplane slows down, gently lower the nose and apply the brakes. Braking is most effective when flaps are raised and back pressure is applied to the control wheel, putting most of the aircraft weight on the main wheels. In high wind conditions, particularly in strong crosswinds, it may be desirable to approach the ground at higher than normal speeds with partial or no flaps.

**4.31 STOPPING ENGINE (4.5m)****CAUTION**

The flaps must be placed in the UP position for the flap step to support weight. Passengers should be cautioned accordingly.

At the pilot's discretion, the flaps should be raised.

**4.31 STOPPING ENGINE (4.5m) (continued)**

The electric fuel pump, air conditioner, radios, and all electrical switches should be turned OFF. Set the propeller in the full INCREASE position. Stop the engine by disengaging the mixture control lock and pulling the mixture control back to idle cut-off. The throttle should be left full aft to avoid engine vibration while stopping. Then the magneto, alternator, and battery master switches must be turned OFF.

**4.33 MOORING (4.5n)**

If necessary, the airplane should be moved on the ground with the aid of the nose wheel tow bar provided with each airplane and secured behind the rear seats. The flaps are locked when in the UP position and should be left retracted. The aileron and stabilator controls should be secured by looping the safety belt through the control wheel and pulling it snug.

Tiedowns can be secured to rings provided under each wing and to the tail skid. The rudder is held in position by its connections to the nose wheel steering and normally does not have to be secured.

**4.35 STALLS**

The stall characteristics of the Arrow are conventional. An approaching stall is indicated by a stall warning horn which is activated between five and ten knots above stall speed. Mild airframe buffeting and gentle pitching may also precede the stall.

The gross weight stalling speed of the Arrow with power off and full flaps is 55 KIAS. With the flaps up this speed is increased 5 KTS. Loss of altitude during stalls can be as great as 400 feet, depending on configuration and power.

**NOTE**

The stall warning system is inoperative with the battery master switch OFF.

During preflight, the stall warning system should be checked by turning the battery master switch ON, lifting the detector and checking to determine if the horn is actuated. The battery master switch should be returned to the OFF position after the check is complete.

**4.37 TURBULENT AIR OPERATION**

In keeping with good operating practice used in all aircraft, it is recommended that when turbulent air is encountered or expected, the airspeed be reduced to maneuvering speed to reduce the structural loads caused by gusts and to allow for inadvertent speed build-ups which may occur as a result of the turbulence or of distractions caused by the conditions.

**4.39 LANDING GEAR**

The pilot should become familiar with the function and significance of the landing gear position indicators and warning lights.

**WARNING**

The NAV LIGHT switch must be off to obtain full intensity gear lights during daytime flying. When aircraft is operated at night and NAV LIGHT switch is turned on, gear lights will automatically dim.

The red gear warning light on the instrument panel and the gear warning horn operate simultaneously in flight when the throttle is reduced to where the manifold pressure is approximately 14 inches of mercury or below, and the gear is not in the DOWN position. The red gear warning light and horn will also operate simultaneously on the ground when the battery master switch is ON, the gear selector switch is in the UP position, and the throttle is in the retarded position.

The three green lights on the instrument panel operate individually as each associated gear is locked in the extended position.

When the Emergency Landing Gear Extension Procedure (paragraph 3.31) is performed for training purposes, the hydraulic pump must be deactivated by pulling the LANDING GEAR PUMP circuit breaker in order for the procedure to extend the gear. Upon completion of the procedure, reset the LANDING GEAR PUMP circuit breaker to resume normal operation of the system.



**4.41 WEIGHT AND BALANCE**

It is the responsibility of the owner and pilot to determine that the airplane remains within the allowable weight vs. center of gravity envelope while in flight.

For weight and balance data, refer to Section 6 (Weight and Balance).

**4.43 NOISE LEVEL**

The noise level of this aircraft is 75.5 d B(A).

No determination has been made by the Federal Aviation Administration that the noise levels of this airplane are or should be acceptable or unacceptable for operation at, into, or out of, any airport.

The above statement notwithstanding the noise level stated above has been verified by and approved by the Federal Aviation Administration in noise level test flights conducted in accordance with FAR 36, Noise Standards - Aircraft Type and Airworthiness Certification. This aircraft model is in compliance with all FAR 36 noise standards applicable to this type.

**TABLE OF CONTENTS**

**SECTION 5**

**PERFORMANCE**

| <b>Paragraph<br/>No.</b> |   | <b>Page<br/>No.</b> |
|--------------------------|---|---------------------|
| 5.1                      | General .....   | 5-1                 |
| 5.3                      | Introduction to Performance and Flight Planning ..... | 5-1                 |
| 5.5                      | Flight Planning Example .....                         | 5-3                 |
| 5.7                      | Performance Graphs .....                              | 5-9                 |
|                          | List of Figures .....                                 | 5-9                 |

**THIS PAGE INTENTIONALLY LEFT BLANK**

**SECTION 5  
PERFORMANCE**

**5.1 GENERAL**

All of the required (FAA regulations) and complementary performance information is provided by this section.

Performance information associated with those optional systems and equipment which require handbook supplements is provided by Section 9 (Supplements).

**5.3 INTRODUCTION - PERFORMANCE AND FLIGHT PLANNING**

The performance information presented in this section is based on measured Flight Test Data corrected to I.C.A.O. standard day conditions and analytically expanded for the various parameters of weight, altitude, temperature, etc.

The performance charts are unfactored and do not make any allowance for varying degrees of pilot proficiency or mechanical deterioration of the aircraft. This performance, however, can be duplicated by following the stated procedures in a properly maintained airplane.

Effects of conditions not considered on the charts must be evaluated by the pilot, such as the effect of soft or grass runway surface on takeoff and landing performance, or the effect of winds aloft on cruise and range performance. Endurance can be grossly affected by improper leaning procedures, and inflight fuel flow and quantity checks are recommended.

**REMEMBER!** To get chart performance, follow the chart procedures.

The information provided by paragraph 5.5 (Flight Planning Example) outlines a detailed flight plan using the performance charts in this section. Each chart includes its own example to show how it is used.

**WARNING**

Performance information derived by extrapolation beyond the limits shown on the charts should not be used for flight planning purposes.

**THIS PAGE INTENTIONALLY LEFT BLANK**

**5.5 FLIGHT PLANNING EXAMPLE****(a) Aircraft Loading**

The first step in planning the flight is to calculate the airplane weight and center of gravity by utilizing the information provided by Section 6 (Weight and Balance) of this handbook.

The basic empty weight for the airplane as licensed at the factory has been entered in Figure 6-5. If any alterations to the airplane have been made effecting weight and balance, reference to the aircraft logbook and Weight and Balance Record (Figure 6-7) should be made to determine the current basic empty weight of the airplane.

Make use of the Weight and Balance Loading Form (Figure 6-11) and the C.G. Range and Weight graph (Figure 6-15) to determine the total weight of the airplane and the center of gravity position.

After proper utilization of the information provided, the following weights have been determined for consideration in the flight planning example.

The landing weight cannot be determined until the weight of the fuel to be used has been established [refer to item (g)(1)].

|  |           |
|--|-----------|
| (1) Basic Empty Weight                           | 1890 lbs. |
| (2) Occupants (2 x 170 lbs.)                     | 340 lbs.  |
| (3) Baggage and Cargo                            | 70 lbs.   |
| (4) Fuel (6 lb./gal. x 51.3)                     | 308 lbs.  |
| (5) Engine Start, Taxi, and Run Up               | -8 lbs.   |
| (6) Takeoff Weight                               | 2600 lbs. |
| (7) Landing Weight                               |           |
| (a)(6) minus (g)(1), (2600 lbs. minus 73.2 lbs.) | 2526 lbs. |

The takeoff weight is below the maximum of 2750 lbs., and the weight and balance calculations have determined the C.G. position to be within approved limits.

**5.5 FLIGHT PLANNING EXAMPLE (continued)**

**(b) Takeoff and Landing**

Now that the airplane loading has been determined, all aspects of the takeoff and landing must now be considered.

All of the existing conditions at the departure and destination airport must be acquired, evaluated and maintained throughout the flight.

Apply the departure airport conditions and takeoff weight to the appropriate Takeoff Performance and Takeoff Ground Roll graph (Figures 5-9, 5-11, 5-13 and 5-15) to determine the length of runway necessary for the takeoff and/or the barrier distance.

The landing distance calculations are performed in the same manner using the existing conditions at the destination airport and, when established, the landing weight.

The conditions and calculations for the example flight are listed below. The takeoff and landing distances required for the flight have fallen well below the available runway lengths.

|                             | Departure<br>Airport | Destination<br>Airport |
|-----------------------------|----------------------|------------------------|
| (1) Pressure Altitude       | 1900 ft.             | 1900 ft.               |
| (2) Temperature             | 20°C                 | 20°C                   |
| (3) Wind Component          | 4 KTS                | 2 KTS                  |
| (4) Runway Length Available | 3000 ft.             | 4600 ft.               |
| (5) Runway Required         | 2550 ft.*            | 1490 ft.**             |

**NOTE**

The remainder of the performance charts used in this flight planning example assume a no wind condition. The effect of winds aloft must be considered by the pilot when computing climb, cruise and descent performance.

\*reference Figure 5-13

\*\*reference Figure 5-39

**5.5 FLIGHT PLANNING EXAMPLE (continued)**

**(c) Climb**

The next step in the flight plan is to determine the necessary climb segment components.

The desired cruise pressure altitude and corresponding cruise outside air temperature values are the first variables to be considered in determining climb components from the Fuel, Time and Distance to Climb graph (Figure 5-21). After the fuel, time and distance for the cruise pressure altitude and outside air temperature values have been established, apply the existing conditions at the departure field to the graph (Figure 5-21). Subtract the values obtained from the graph for the field of departure conditions for those for the cruise pressure altitude.

The remaining values are the true fuel, time and distance components for the climb segment of the flight plan corrected for field pressure altitude and temperature.

The following values were determined from the above instructions in the flight planning example:

- |   |                 |
|---|-----------------|
| (1) Cruise Pressure Altitude                                  | 6000 ft.        |
| (2) Cruise OAT  | 10°C            |
| (3) Fuel to Climb (4 gal. minus 1.0 gal.)                     | 3.0 gal.*       |
| (4) Time to Climb (10 min. minus 3.5 min.)                    | 6.5 min.*       |
| (5) Distance to Climb (17 naut. miles<br>minus 6 naut. miles) | 11 naut. miles* |

**(d) Descent**

The descent data will be determined prior to the cruise data to provide the descent distance for establishing the total cruise distance.

Utilizing the cruise pressure altitude and OAT, determine the basic fuel, time, and distance for descent (Figure 5-35). These figures must be adjusted for the field pressure altitude and temperature at the destination airport. To find the necessary adjustment values, use the existing pressure altitude and temperature conditions at the destination airport as variables to find the fuel, time and distance

\*reference Figure 5-21



**5.5 FLIGHT PLANNING EXAMPLE (continued)**

values from the graph (Figure 5-35). Subtract the values obtained from the field conditions from the values obtained from the cruise conditions to find the true fuel, time and distances values needed for the flight plan.

The values obtained by proper utilization of the graphs for the descent segment of the example are shown below:

- |  |                   |
|--|-------------------|
| (1) Fuel to Descend<br>(1.0 gal. minus 0.5 gal.)                     | 0.5 gal.*         |
| (2) Time to Descend<br>(7 min. minus 3 min.)                         | 4 min.*           |
| (3) Distance to Descend<br>(18 naut. miles minus<br>7.5 naut. miles) | 10.5 naut. miles* |

(e) Cruise

Using the total distance to be traveled during the flight, subtract the previously calculated distance to climb and distance to descend to establish the total cruise distance. Refer to the Power Setting Table (Figure 5-23 or 5-23a) when selecting the cruise power setting. The established pressure altitude and temperature values and the selected cruise power should now be utilized to determine the true airspeed from the appropriate Speed Power graph (Figure 5-25 through 5-27c).

For this example, 65% Economy Cruise at 2500 RPM was used. Calculate the cruise flow for the cruise power setting from the information provided by the Best Economy Range chart (Figure 5-31a).

The cruise time is found by dividing the cruise distance by the cruise speed and the cruise fuel is found by multiplying the cruise fuel flow by the cruise time.

The cruise calculations established for the cruise segment of the flight planning example are as follows:

- |  |                   |
|--|-------------------|
| (1) Total Distance   | 130 naut. miles   |
| (2) Cruise Distance<br>(e)(1) minus (c)(5) minus (d)(3),<br>(130 naut. miles minus 11 naut.<br>miles minus 10.5 naut. miles) | 108.5 naut. miles |

\*reference Figure 5-35

5.5 FLIGHT PLANNING EXAMPLE (continued)

|   |                               |
|---|-------------------------------|
| (3) Cruise Power (Best Economy)                                     | 65% rated power<br>(2500 RPM) |
| (4) Cruise Delta OAT from ISA (10° C - 3° C)                        | 7° C                          |
| (5) Cruise Manifold Press. (23.1 + [7/5.5 x .16])                   | 23.3 in Hg                    |
| (6) Cruise Speed  | 130 Kts TAS*                  |
| (7) Cruise Fuel Consumption   | 10.3 gph*                     |
| (8) Cruise Time   |                               |
| (e)(2) divided by (e)(6), (108.5 naut.<br>miles divided by 130 KTS) | .84 hrs.<br>(51 min.)         |
| (9) Cruise Fuel   |                               |
| (e)(7) multiplied by (e)(8), (10.3<br>gph multiplied by .84 hrs.)   | 8.7 gal.                      |

(f) Total Flight Time

The total flight time is determined by adding the time to climb, the time to descend and the cruise time. Remember! The time values taken from the climb and descent graphs are in minutes and must be converted to hours before adding them to the cruise time.

The following flight time is required for the flight planning example:

|  |                      |
|--|----------------------|
| (1) Total Flight Time  |                      |
| (c)(4) plus (d)(2) plus (e)(8),<br>(.11 hrs. plus .07 hrs. plus .84 hrs.)<br>(6.5 min. plus 4 min. plus 51 min.) | 1.02 hrs., 61.5 min. |

(g) Total Fuel Required

Determine the total fuel required by adding the fuel to climb, the fuel to descend and the cruise fuel. When the total fuel (in gallons) is determined, multiply this value by 6 lb./gal. to determine the total fuel weight used for the flight.

The total fuel calculations for the example flight plan are shown below:

|   |                        |
|---|------------------------|
| (1) Total Fuel Required   |                        |
| (c)(3) plus (d)(1) plus (e)(9),<br>(3.0 gal. plus 0.5 gal. plus 8.7 gal.)<br>(12.2 gal. multiplied by 6 lb./gal.) | 12.2 gal.<br>73.2 lbs. |

\*reference Figure 5-27c

**THIS PAGE INTENTIONALLY LEFT BLANK**

## 5.7 PERFORMANCE GRAPHS

## LIST OF FIGURES

| Figure No. |  | Page No. |
|------------|--|----------|
| 5-1a       | Air Temperatures above & below ISA.....                | 5-10a    |
| 5-1        | Temperature Conversion.....                            | 5-11     |
| 5-3        | Airspeed System Calibration.....                       | 5-12     |
| 5-5        | Power Off Stall Speed Vs. Angle of Bank.....           | 5-13     |
| 5-7        | Wind Components.....                                   | 5-14     |
| 5-9        | 25° Flap Takeoff Performance Over 50 Foot Barrier..... | 5-15     |
| 5-11       | 25° Flap Takeoff Ground Roll.....                      | 5-16     |
| 5-13       | 0° Flap Takeoff Performance Over 50 Foot Barrier.....  | 5-17     |
| 5-15       | 0° Flap Takeoff Ground Roll.....                       | 5-18     |
| 5-17       | Gear Up Climb Performance.....                         | 5-19     |
| 5-19       | Gear Down Climb Performance.....                       | 5-20     |
| 5-21       | Fuel, Time and Distance to Climb.....                  | 5-21     |
| 5-23       | Power Setting Table (Best Power).....                  | 5-23     |
| 5-23a      | Power Setting Table (Best Economy).....                | 5-24     |
| 5-25       | Best Power Cruise (75%).....                           | 5-25     |
| 5-25a      | Best Power Cruise (65%).....                           | 5-25a    |
| 5-25b      | Best Power Cruise (55%).....                           | 5-25b    |
| 5-27       | Best Economy Cruise (55% 2200 RPM).....                | 5-26     |
| 5-27a      | Best Economy Cruise (55% 2500 RPM).....                | 5-26a    |
| 5-27b      | Best Economy Cruise (65% 2500 RPM).....                | 5-26b    |
| 5-27c      | Best Economy Cruise (65% 2500 RPM).....                | 5-26c    |

**5.7 PERFORMANCE GRAPHS (Cont'd)**

**LIST OF FIGURES (Cont'd)**

|   |       |
|---|-------|
| 5-29 Best PowerRange (2500 RPM).....            | 5-27  |
| 5-29a Best PowerRange (2200 RPM).....           | 5-27a |
| 5-31 Best Economy Range (2200RPM).....          | 5-27b |
| 5-31a Best Economy Range (2500RPM).....         | 5-28  |
| 5-33 Best Power Endurance (2500 RPM).....       | 5-29  |
| 5-33a Best Power Endurance (2200 RPM).....      | 5-29a |
| 5-33b Best Economy Endurance (2500 RPM).....    | 5-29b |
| 5-33c Best Economy Endurance (2500 RPM).....    | 5-29c |
| 5-35 Fuel, Time and Distance to Descend.....    | 5-30  |
| 5-37 Glide Time and Distance.....               | 5-31  |
| 5-39 Landing Distance Over 50 Foot Barrier..... | 5-32  |
| 5-41 Landing Ground Roll Distance .....         | 5-33  |

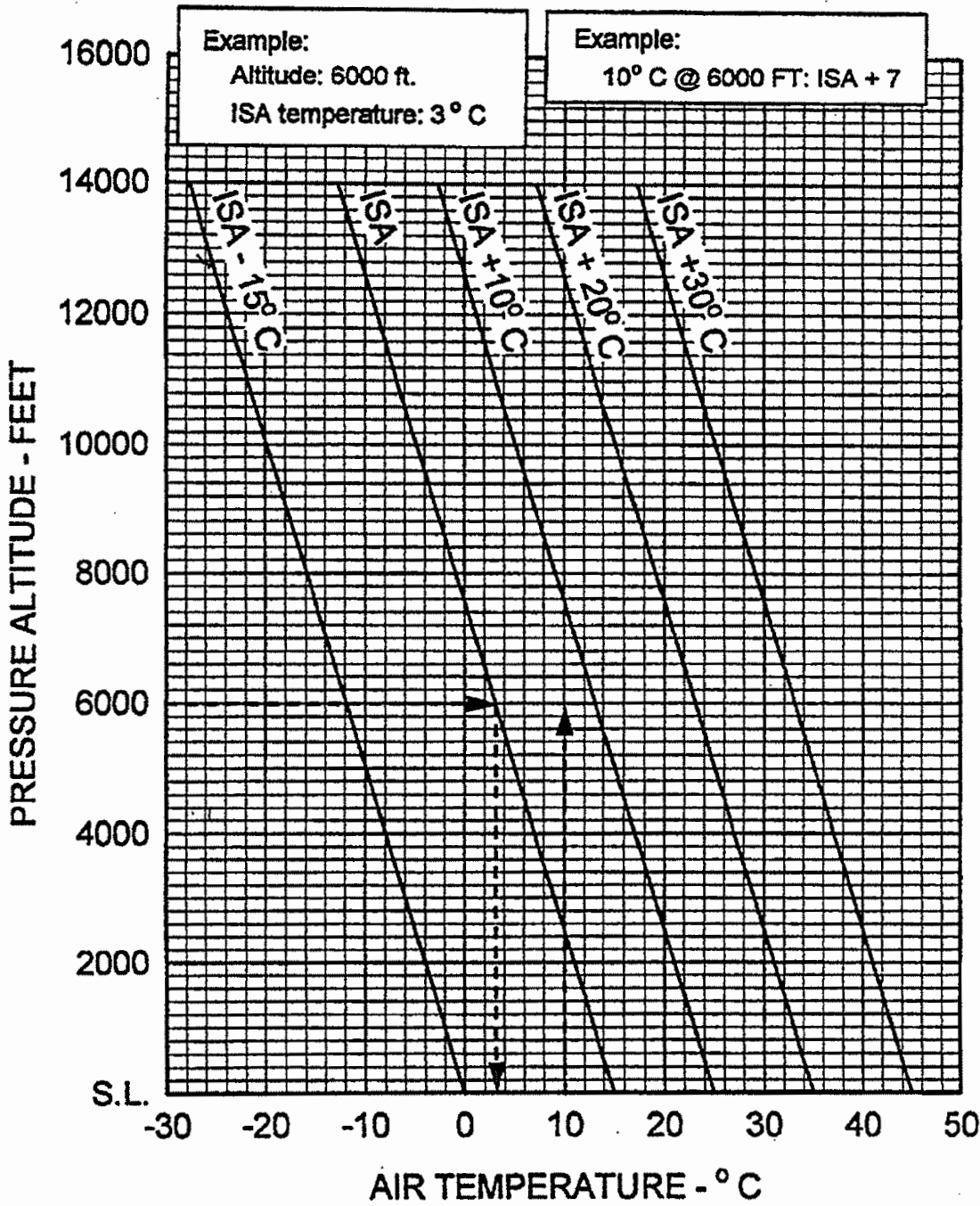

AIR TEMPERATURES ABOVE & BELOW ISA

Figure 5-1a

**THIS PAGE INTENTIONALLY LEFT BLANK**

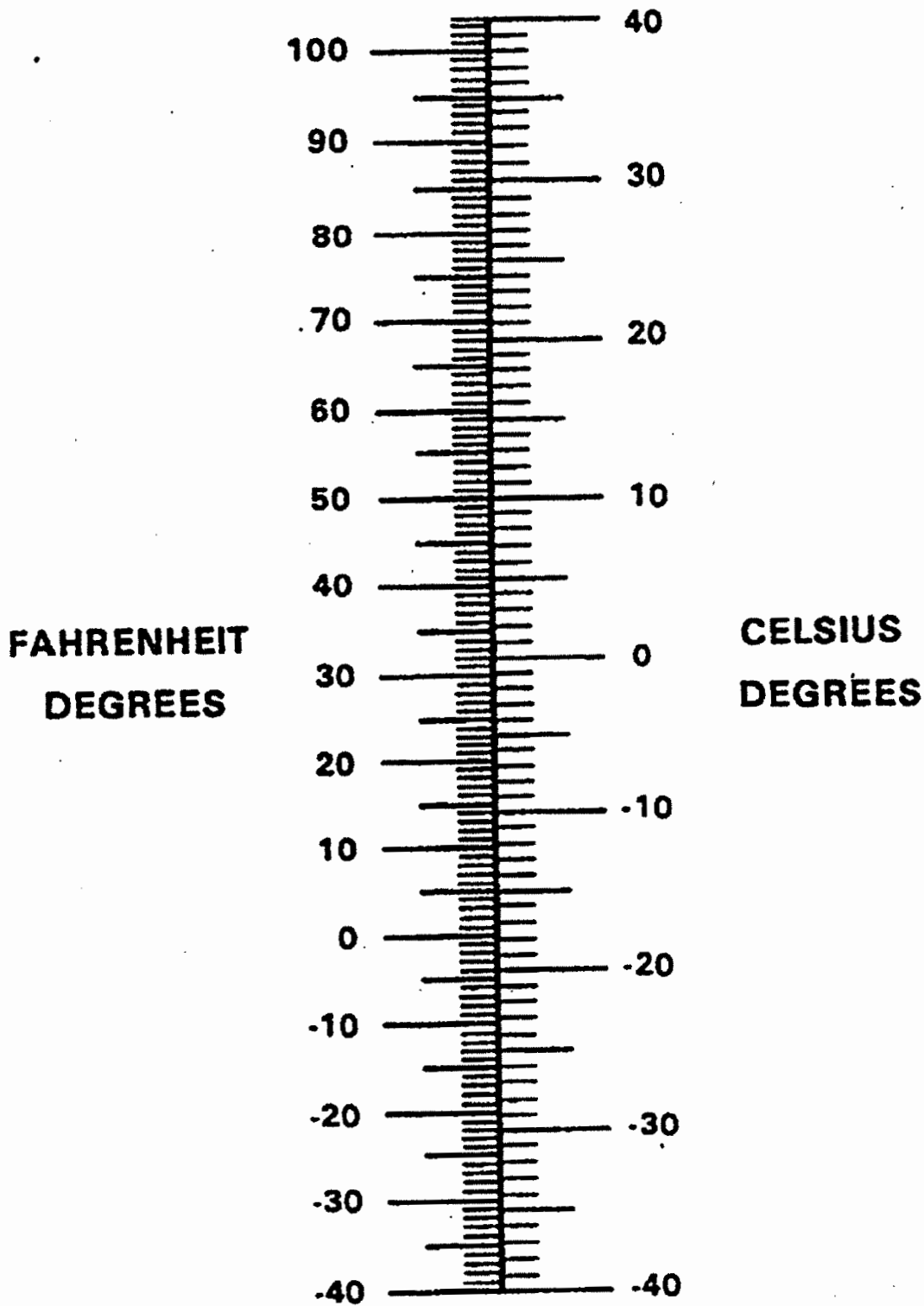

TEMPERATURE CONVERSION  
Figure 5-1



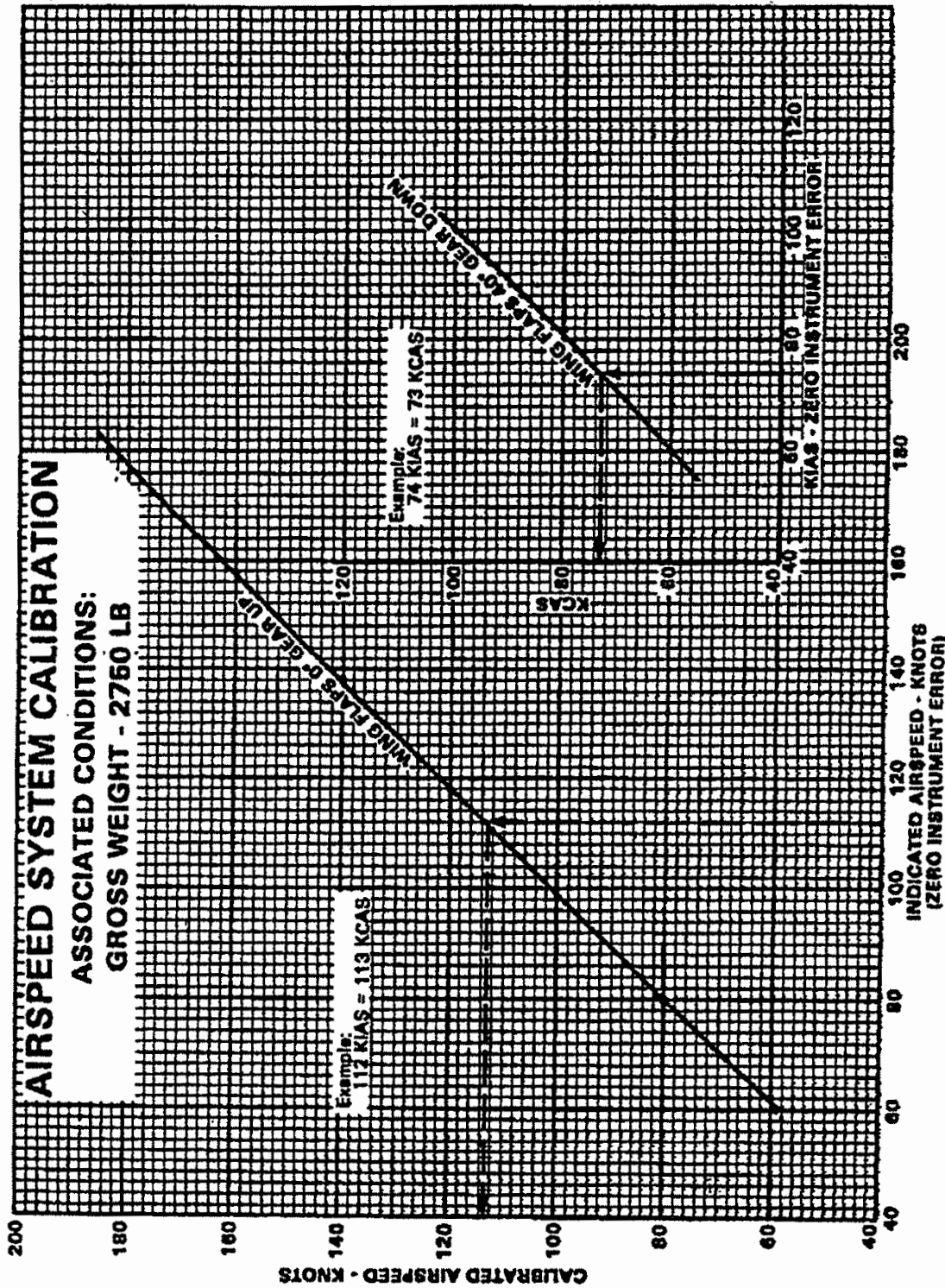

**AIRSPEED SYSTEM CALIBRATION**

Figure 5-3

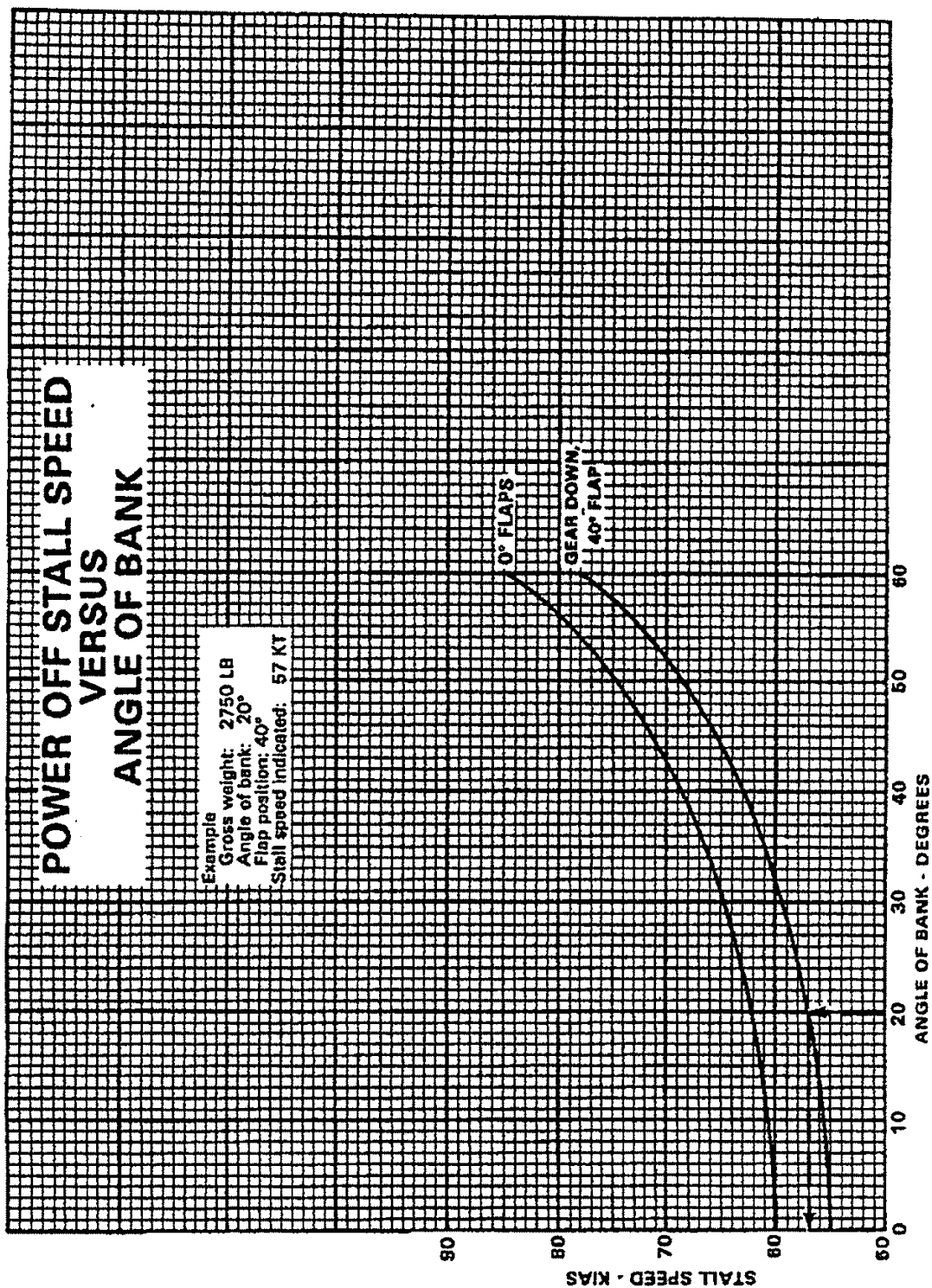

POWER OFF STALL SPEED VS. ANGLE OF BANK

Figure 5-5

# WIND COMPONENTS

Example:

Wind velocity: 30 knots

Angle between flight path and wind: 30°

Headwind component: 26 knots

Crosswind components: 15 knots

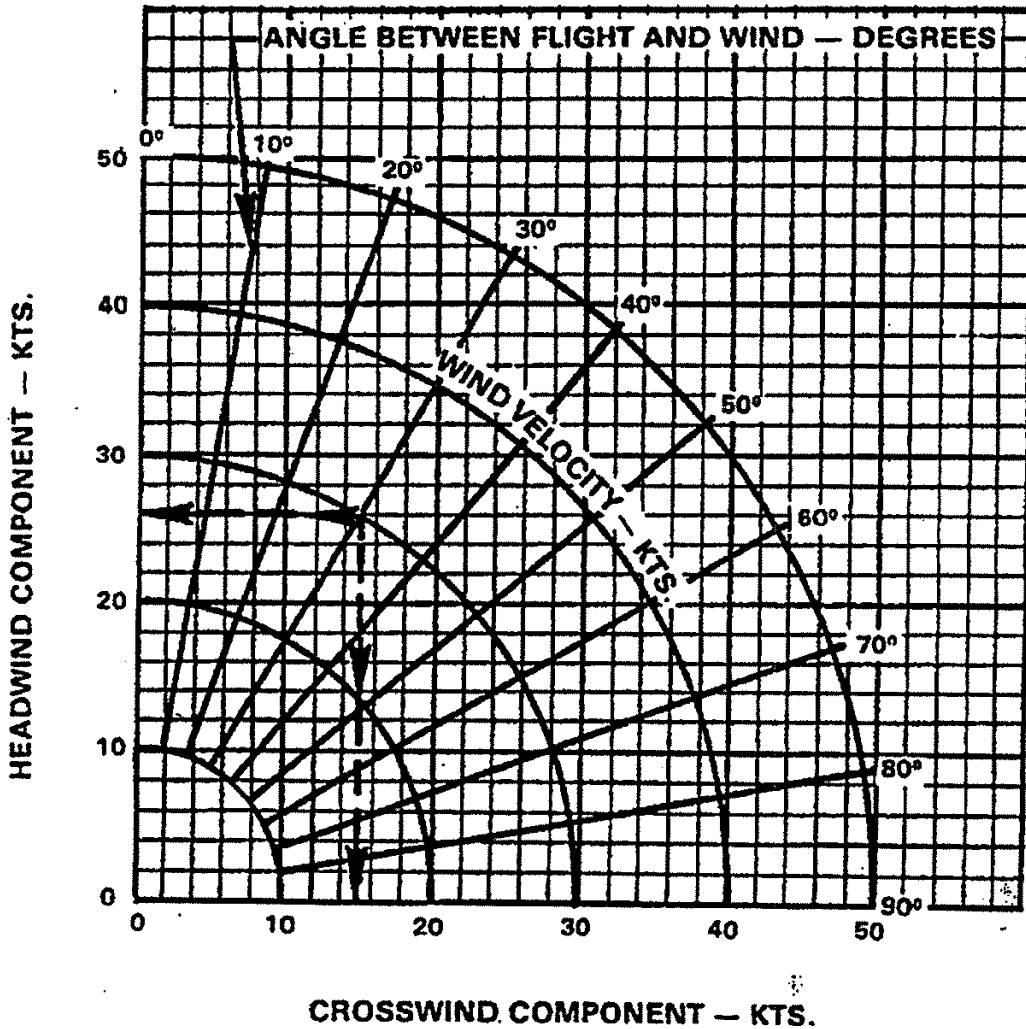

WIND COMPONENTS  
Figure 5-7

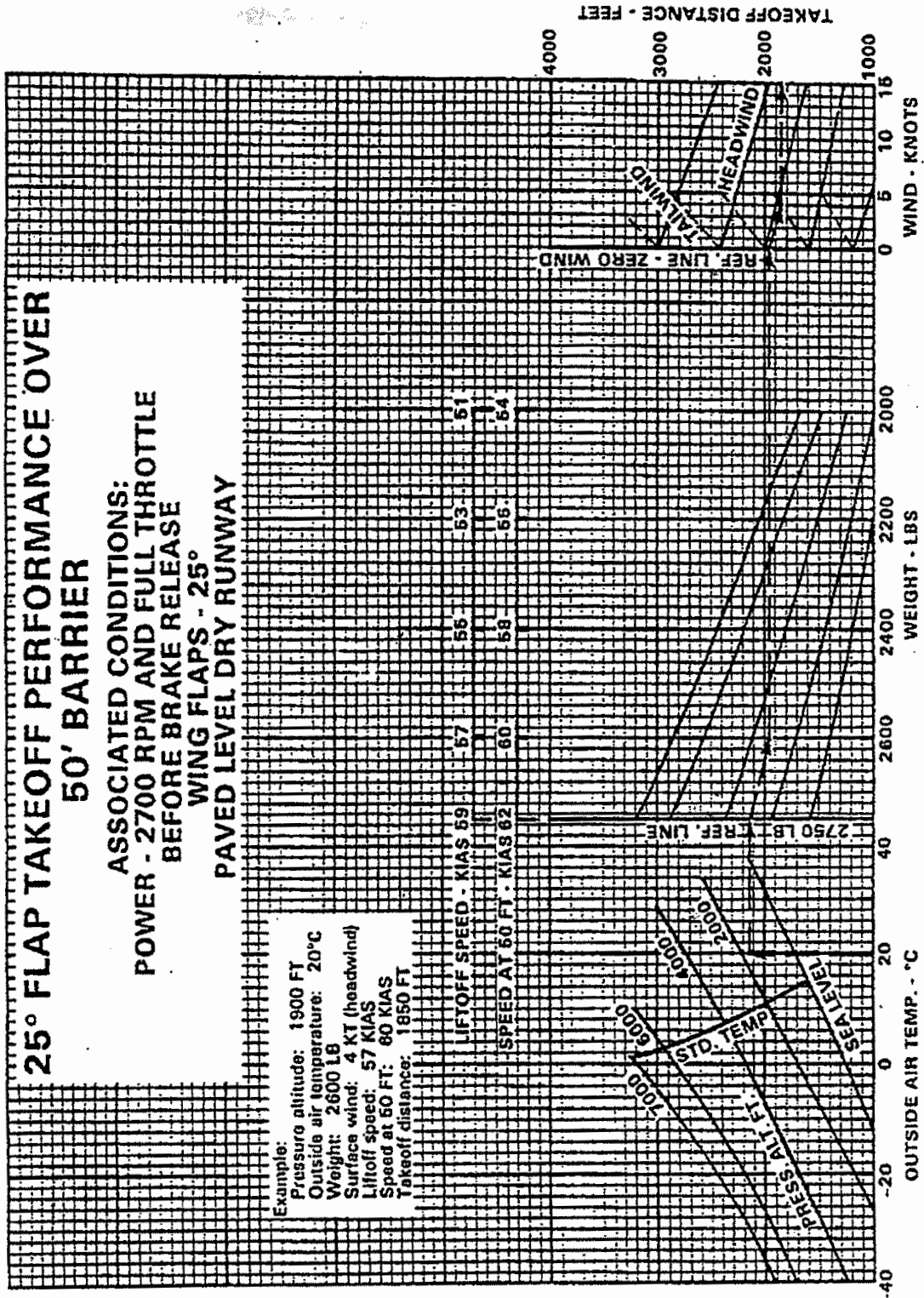

25° FLAP TAKEOFF PERFORMANCE

Figure 5-9

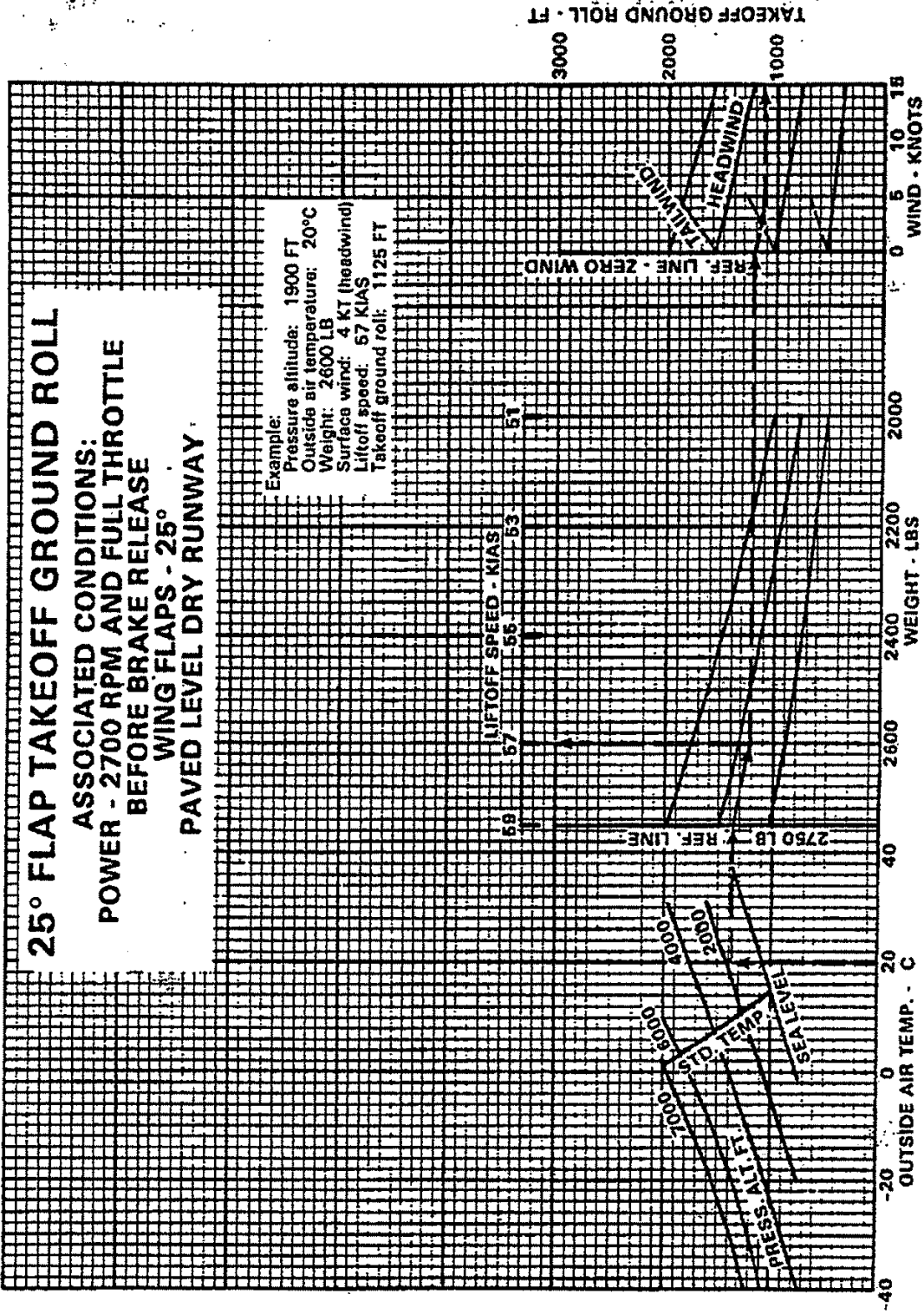

25° FLAP TAKEOFF GROUND ROLL

Figure 5-11

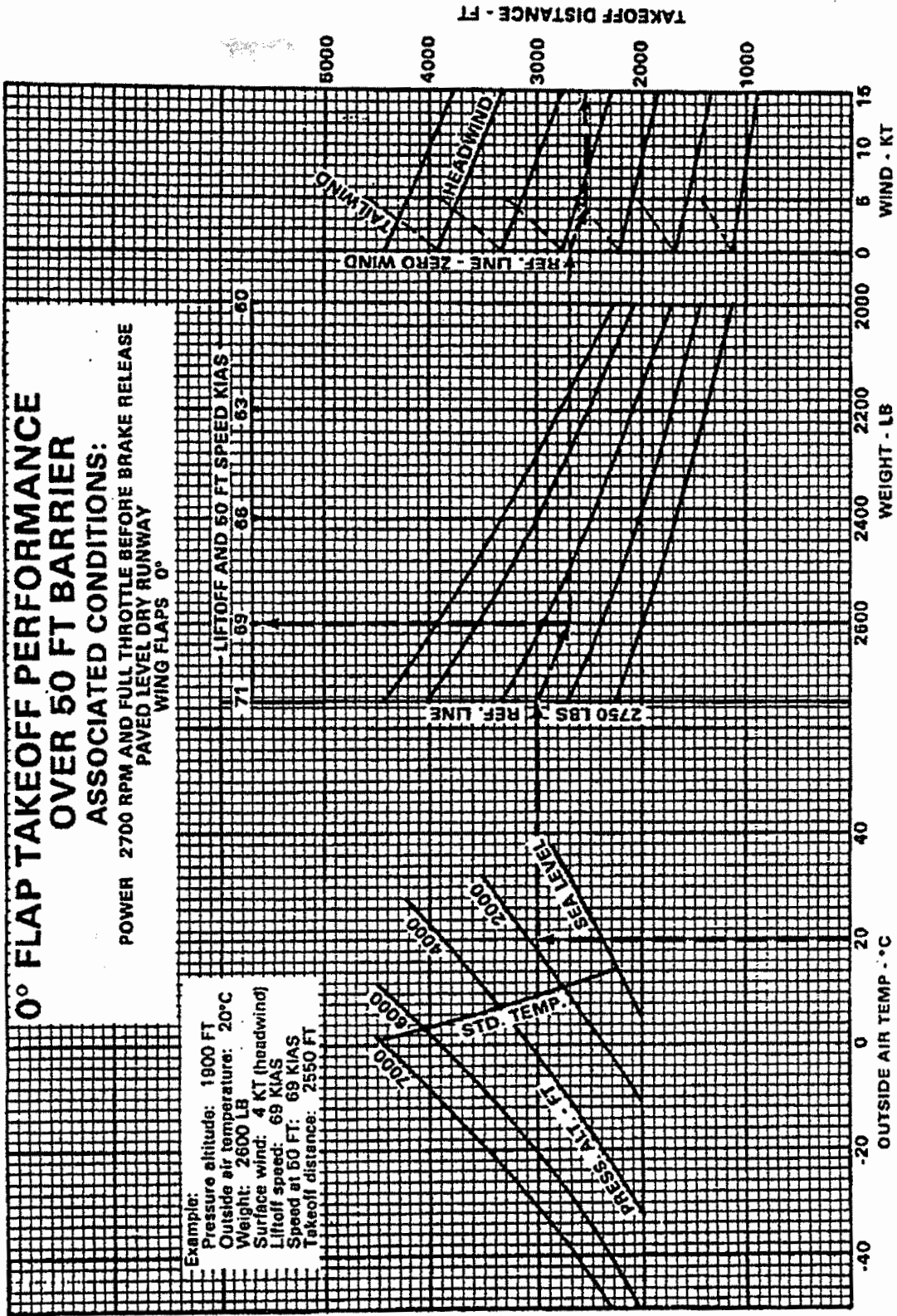

0° FLAP TAKEOFF PERFORMANCE

Figure 5-13

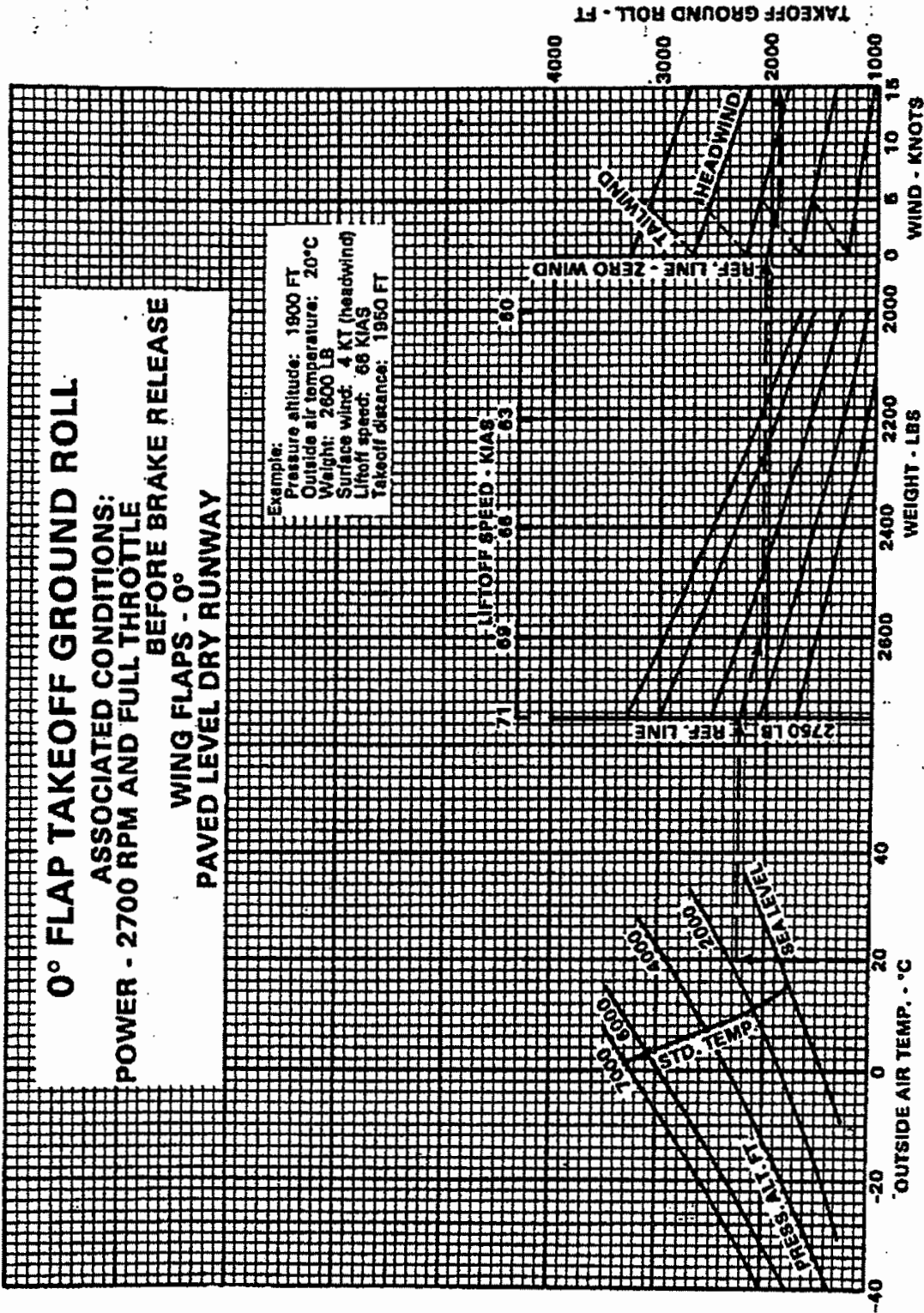

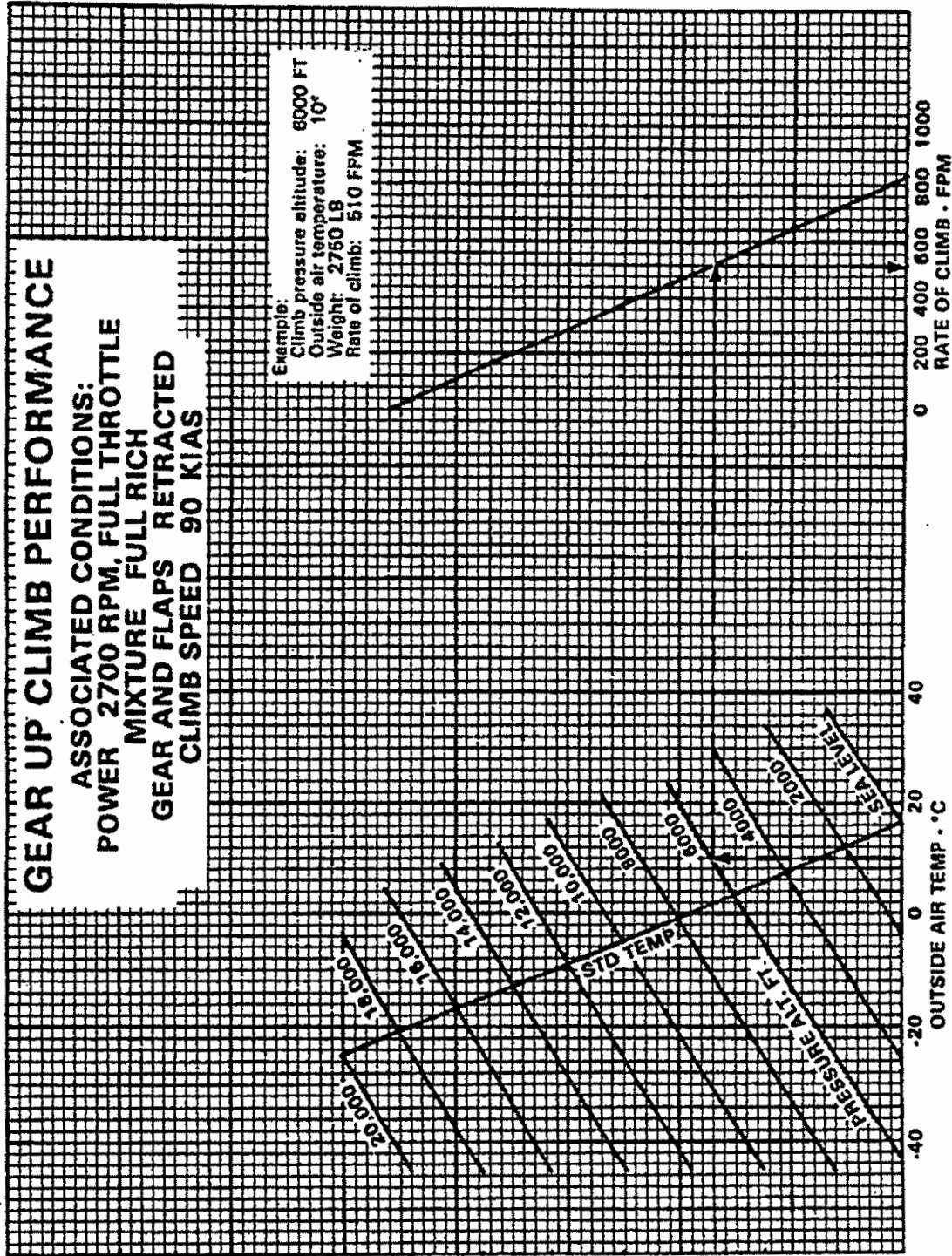

**GEAR UP CLIMB PERFORMANCE**

Figure 5-17



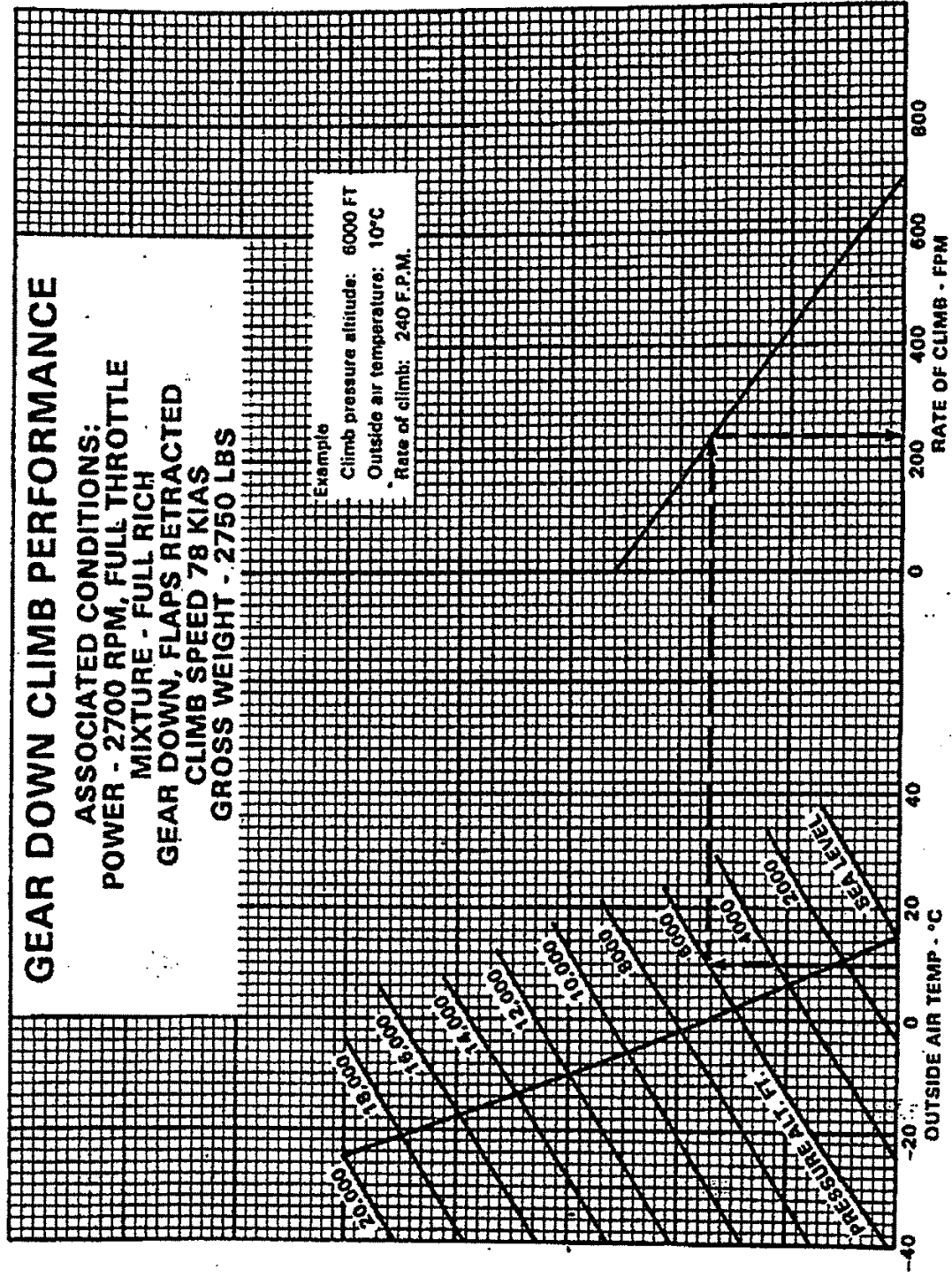

**GEAR DOWN CLIMB PERFORMANCE**  
Figure 5-19

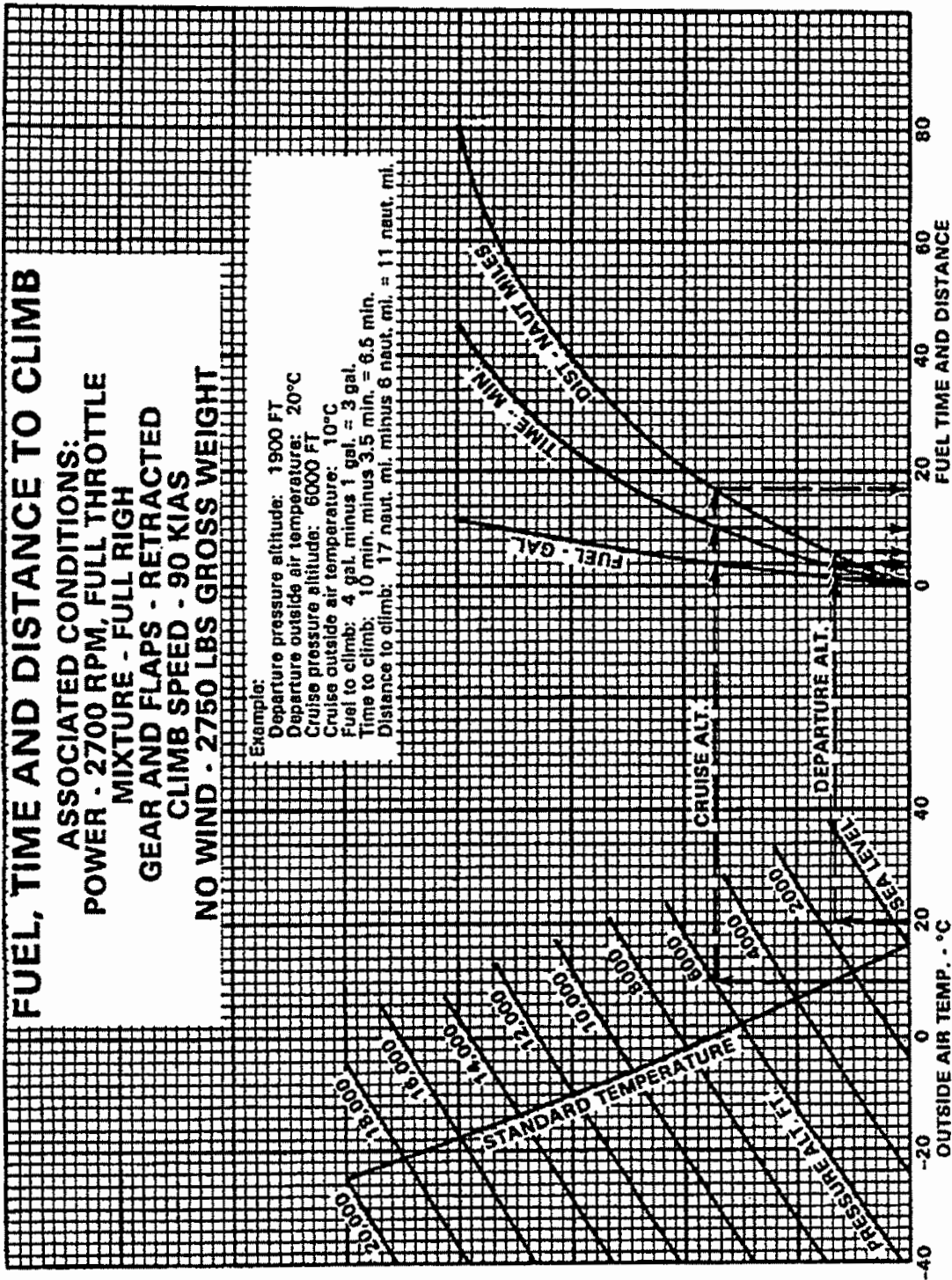

FUEL, TIME AND DISTANCE TO CLIMB

Figure 5-21

**THIS PAGE INTENTIONALLY LEFT BLANK**

**Power Setting Table for Lycoming Model IO-360-C1C6  
Engine as Installed in PA-28R-201 Arrow Best Power Mixture**

| Pressure<br>Altitude | ISA<br>Temperature |     | 55% power<br>110 BHP @ Prop<br>Mixture Peak EGT + 100° F<br>RPM and Manifold Press. |          | 65% power<br>130 BHP @ Prop<br>Mixture Peak EGT + 100° F<br>RPM and Manifold Press. |          | 75% power<br>150 BHP @ Prop<br>Mixture Peak EGT + 100° F<br>RPM and Manifold Press. |          | Pressure<br>Altitude |
|----------------------|--------------------|-----|---|----------|---|----------|---|----------|----------------------|
|                      | °F                 | °C  | 2200 RPM  | 2500 RPM | 2200 RPM  | 2500 RPM | 2200 RPM  | 2500 RPM |                      |
| Feet                 |                    |     |   |          |   |          |   |          | Feet                 |
| S.L.                 | 59                 | 15  | 23.7  | 21.7     | 26.1  | 24.1     | 28.3  | 26.3     | S.L.                 |
| 1000                 | 55                 | 13  | 23.4  | 21.4     | 25.8  | 23.7     | 28.0  | 26.0     | 1000                 |
| 2000                 | 52                 | 11  | 23.0  | 21.1     | 25.4  | 23.4     | 25.6  | 25.6     | 2000                 |
| 3000                 | 48                 | 9   | 22.6  | 20.8     | 25.1  | 23.1     | 25.3  | 25.3     | 3000                 |
| 4000                 | 45                 | 7   | 22.3  | 20.5     | 24.7  | 22.8     | 24.9  | 24.9     | 4000                 |
| 5000                 | 41                 | 5   | 21.9  | 20.2     | 24.3  | 22.4     | 24.6  | 24.6     | 5000                 |
| 6000                 | 38                 | 3   | 21.6  | 19.9     | 24.0  | 22.1     | 24.3  | 24.3     | 6000                 |
| 6800                 | 35                 | 2   | 21.3  | 19.7     | 23.7  | 21.9     | F.T.  | F.T.     | 6800                 |
| 7000                 | 34                 | 1   | 21.2  | 19.6     | 23.6  | 21.8     |   |          | 7000                 |
| 7500                 | 32                 | 0   | 21.0  | 19.4     | F.T.  | 21.6     |   |          | 7500                 |
| 8000                 | 30                 | -1  | 20.8  | 19.3     |   | 21.5     |   |          | 8000                 |
| 9000                 | 27                 | -3  | 20.5  | 19.0     |   | 21.1     |   |          | 9000                 |
| 9400                 | 25                 | -4  | 20.3  | 18.9     |   | F.T.     |   |          | 9400                 |
| 10000                | 23                 | -5  | F.T.  | 18.7     |   |          |   |          | 10000                |
| 11000                | 19                 | -7  |   | 18.4     |   |          |   |          | 11000                |
| 12000                | 16                 | -9  |   | 18.1     |   |          |   |          | 12000                |
| 13000                | 12                 | -11 |   | 17.8     |   |          |   |          | 13000                |
| 14000                | 9                  | -13 |   | 17.5     |   |          |   |          | 14000                |

Note: To maintain constant power, correct manifold pressure approximately 0.16" Hg for each 10° F (5.5° C) variation in inlet air temperature from standard altitude temperature. Add manifold pressure for air temperatures above standard; subtract for temperatures below standard. Full throttle manifold pressure values may not be obtainable when atmospheric conditions are non-standard.

**POWER SETTING TABLE (Best Power)**

Figure 5-23

**Power Setting Table for Lycoming Model IO-360-C1C6  
Engine as Installed in PA-28R-201 Arrow Best Economy Mixture**

| Pressure<br>Altitude | ISA Temperature |    | 55% Power<br>110 BHP @ Propeller<br>Mixture Peak EGT<br>Manifold Pressure - In. Hg |          | 85% Power<br>130 BHP @ Propeller<br>Mixture Peak EGT<br>Manifold Pressure - In. Hg |          | Pressure<br>Altitude |
|----------------------|-----------------|----|--|----------|--|----------|----------------------|
|                      | °F              | °C | 2200 RPM   | 2500 RPM | 2200 RPM   | 2500 RPM |                      |
| Feet                 |                 |    |  |          |  |          | Feet                 |
| S.L.                 | 59              | 15 | 24.8   | 22.2     | 27.5   | 24.5     | S.L.                 |
| 1000                 | 55              | 13 | 24.4   | 22.0     | 27.1   | 24.3     | 1000                 |
| 2000                 | 52              | 11 | 24.0   | 21.8     | 26.7   | 24.1     | 2000                 |
| 3000                 | 48              | 9  | 23.7   | 21.5     | 26.3   | 23.8     | 3000                 |
| 4000                 | 45              | 7  | 23.3   | 21.3     | 26.0   | 23.6     | 4000                 |
| 5000                 | 41              | 5  | 22.9   | 21.1     | 25.6   | 23.3     | 5000                 |
| 5250                 | 40              | 4  | 22.8   | 21.0     | F.T.   | 23.2     | 5250                 |
| 6000                 | 38              | 3  | 22.5   | 20.8     |  | 23.1     | 6000                 |
| 7000                 | 34              | 1  | 22.1   | 20.6     |  | 22.8     | 7000                 |
| 8000                 | 30              | -1 | 21.8   | 20.4     |  | 22.6     | 8000                 |
| 8750                 | 28              | -2 | 21.5   | 20.2     |  | F.T.     | 8750                 |
| 9000                 | 27              | -3 | F.T.   | 20.1     |  |          | 9000                 |
| 10000                | 23              | -5 |  | 19.9     |  |          | 10000                |
| 11000                | 19              | -7 |  | 19.7     |  |          | 11000                |
| 12000                | 16              | -9 |  | F.T.     |  |          | 12000                |

Note:

To maintain constant power, correct manifold pressure approximately 0.16" Hg for each 10° F (5.5° C) variation in inlet air temperature from standard altitude temperature. Add manifold pressure for air temperatures above standard; subtract for temperatures below standard. Full throttle manifold pressure values may not be obtainable when atmospheric conditions are non-standard.

**POWER SETTING TABLE (Best Economy)**

Figure 5-23a

**BEST POWER CRUISE 75% POWER**

**MIXTURE:** 100° F Rich of Peak EGT 2500 RPM  
**Fuel Flow** 12.7 GPH Gear Up, Flaps Up, 2750 Pounds Gross Wt.

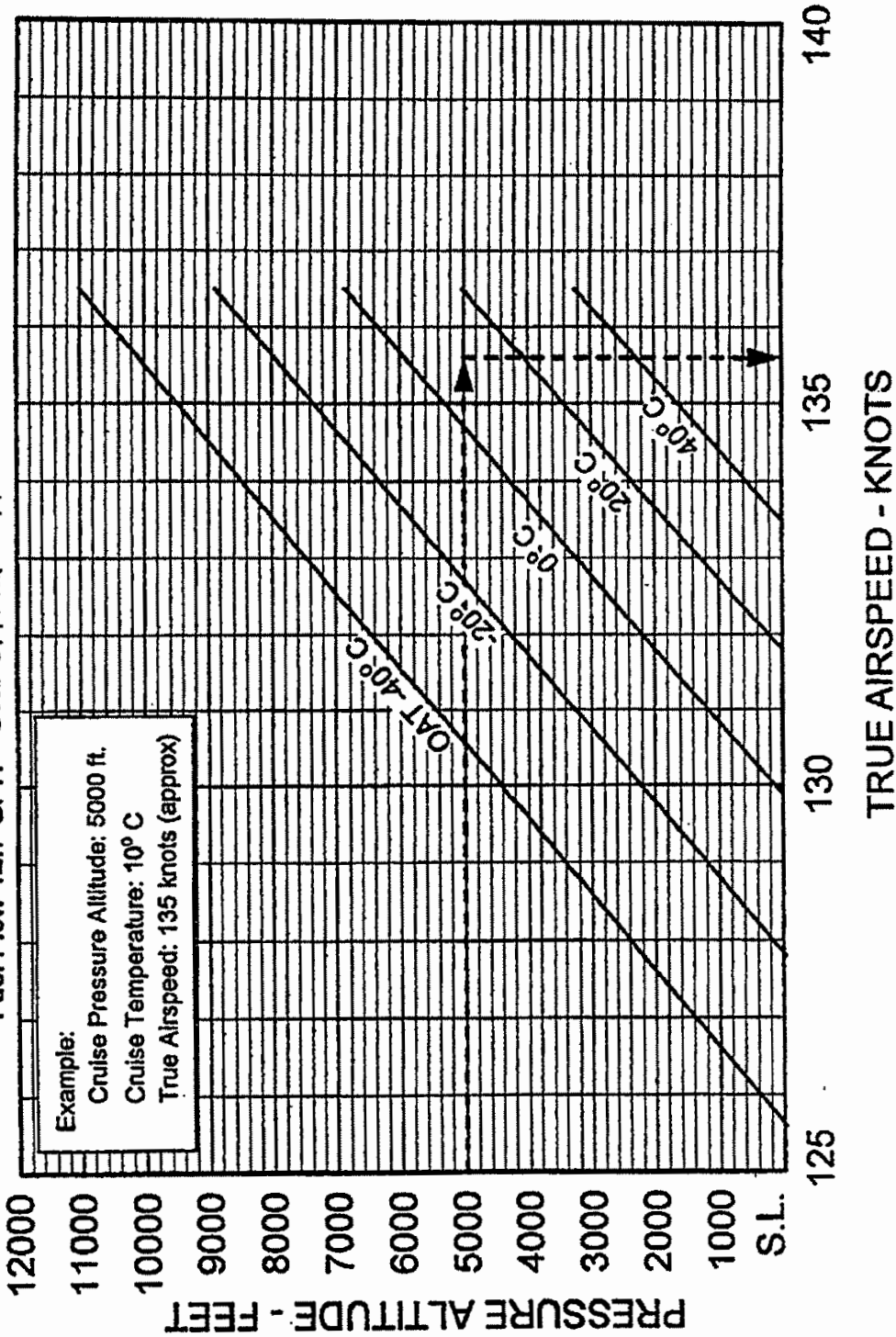

**BEST POWER CRUISE (75% Power)**

Figure 5-25

**BEST POWER CRUISE 65% POWER**

MIXTURE: 100° F Rich of Peak EGT 2500 RPM

Fuel Flow 11.4 GPH Gear Up, Flaps Up, 2750 Pounds Gross Wt.

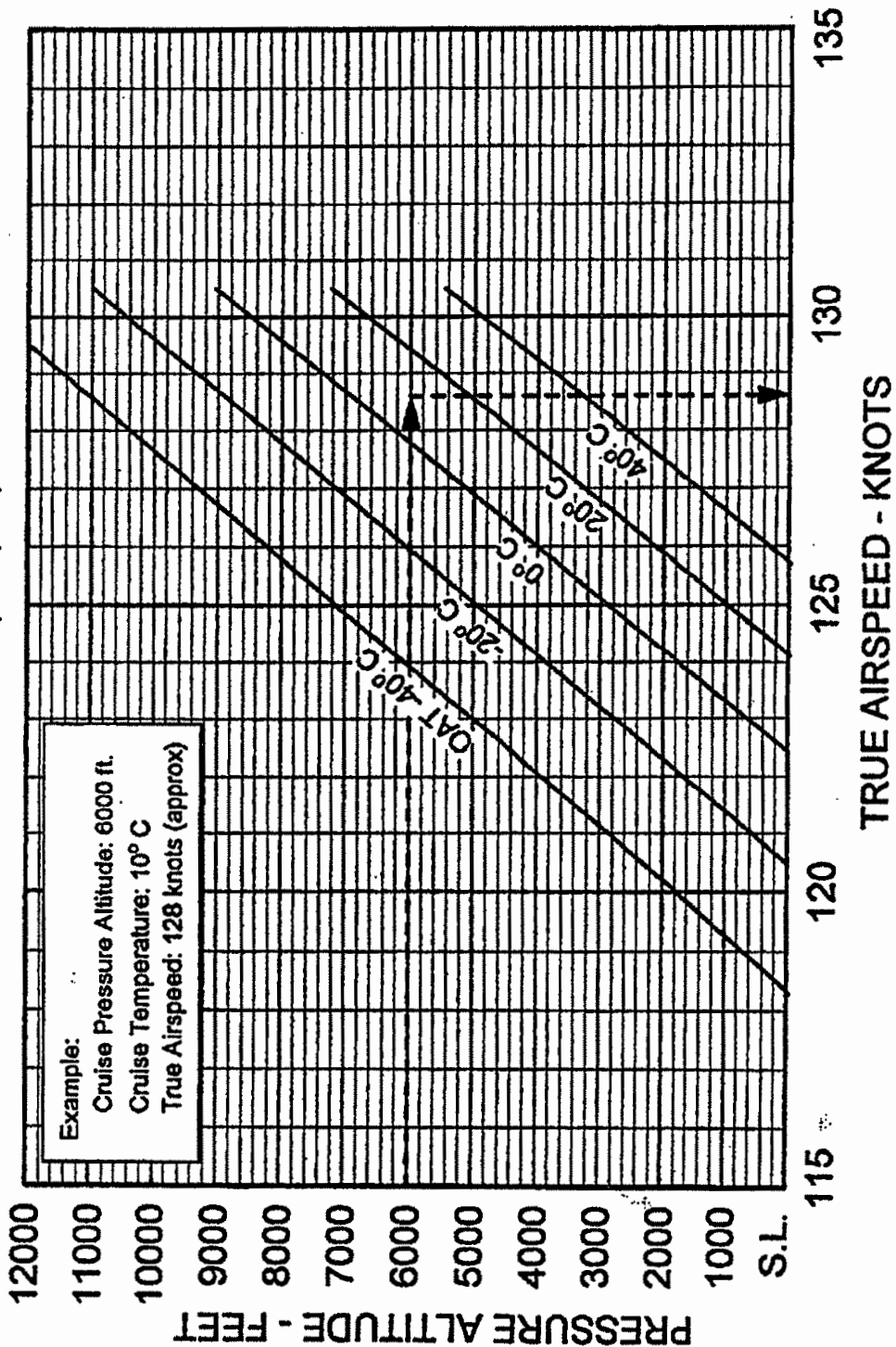

**BEST POWER CRUISE (65% Power)**

Figure 5-25a

**BEST POWER CRUISE 55% POWER**

MIXTURE: 100° F Rich of Peak EGT 2500 RPM

Fuel Flow 10.2 GPH Gear Up, Flaps Up, 2750 Pounds Gross Wt.

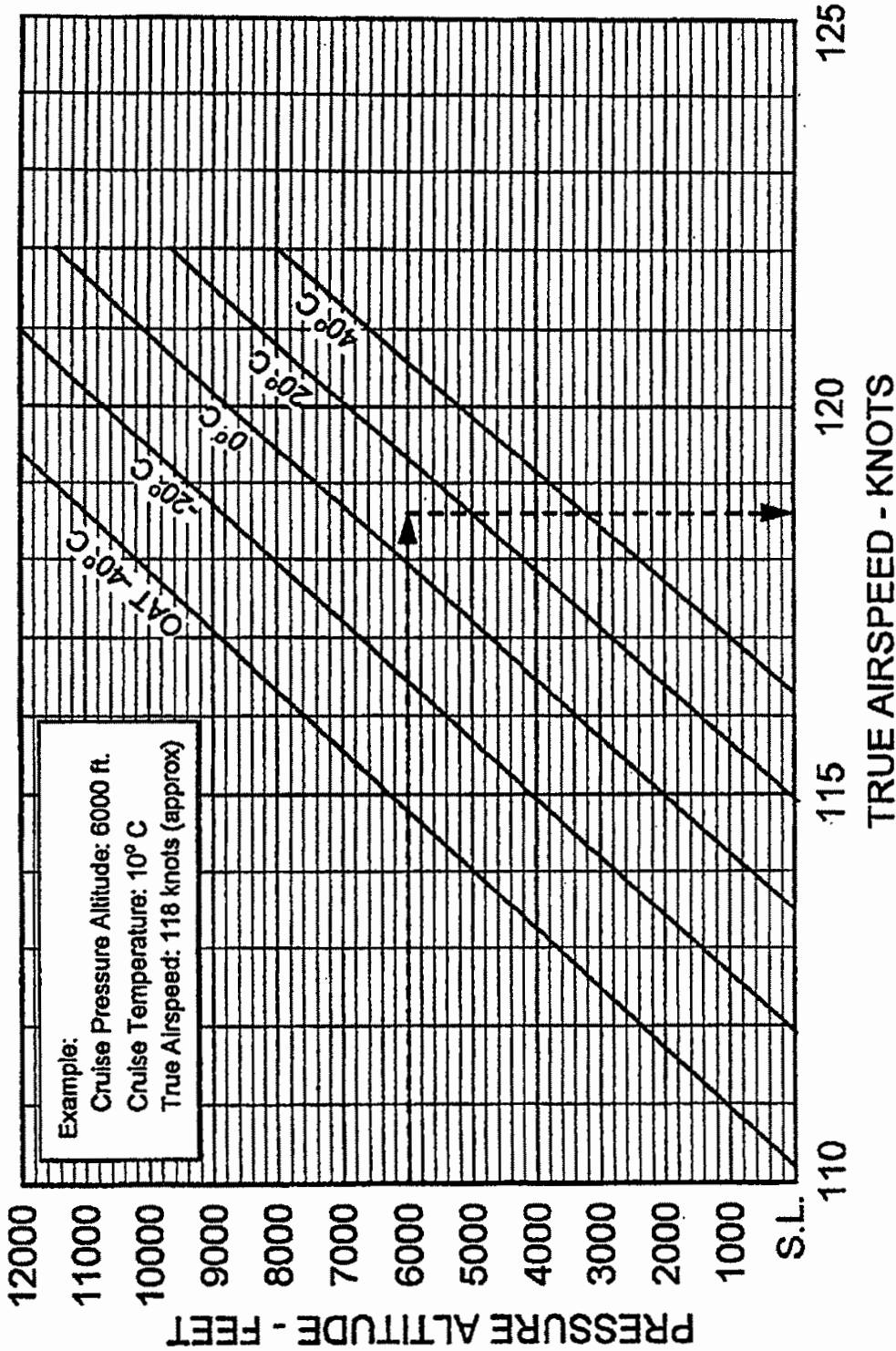

BEST POWER CRUISE (55% Power)

Figure 5-25b



**ECONOMY CRUISE 55% POWER**

**MIXTURE: PEAK EGT CRUISE RPM: 2200**

**Fuel Flow 8.5 GPH Gear Up, Flaps UP, 2750 Pounds Gross Weight**

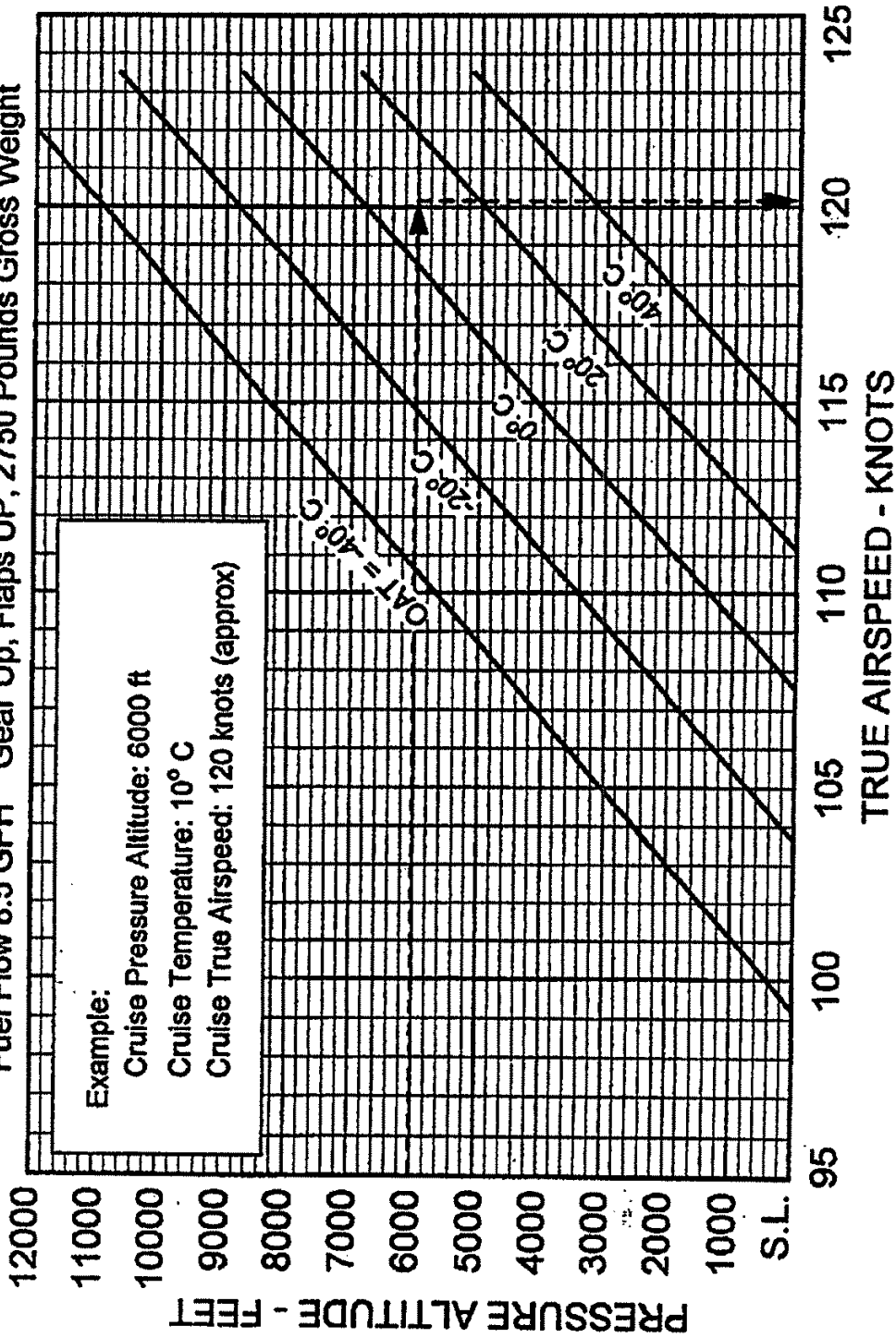

**ECONOMY CRUISE (55% Power 2200 RPM)**

Figure 5-27

**ECONOMY CRUISE 55% POWER**

**MIXTURE: PEAK EGT**    **CRUISE RPM: 2500**

**Fuel Flow 9.0 GPH**    **Gear Up, Flaps Up, 2750 Pounds Gross Weight**

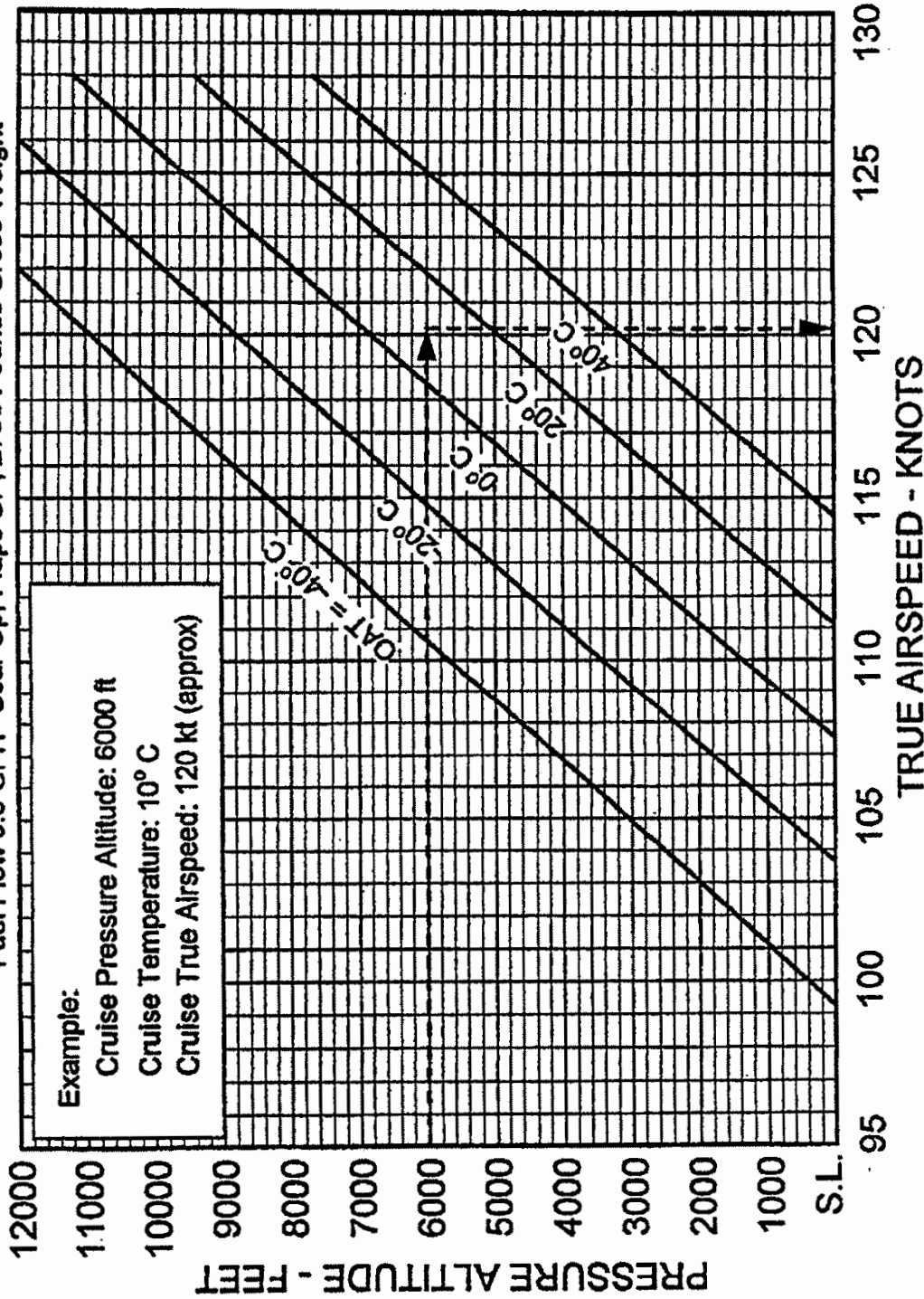

**ECONOMY CRUISE (55% Power 2500 RPM)**

Figure 5-27a

**ECONOMY CRUISE 65% POWER**

**MIXTURE: PEAK EGT** **CRUISE RPM: 2200**

**Fuel Flow 9.8 GPH Gear Up, Flaps UP, 2750 Pounds Gross Weight**

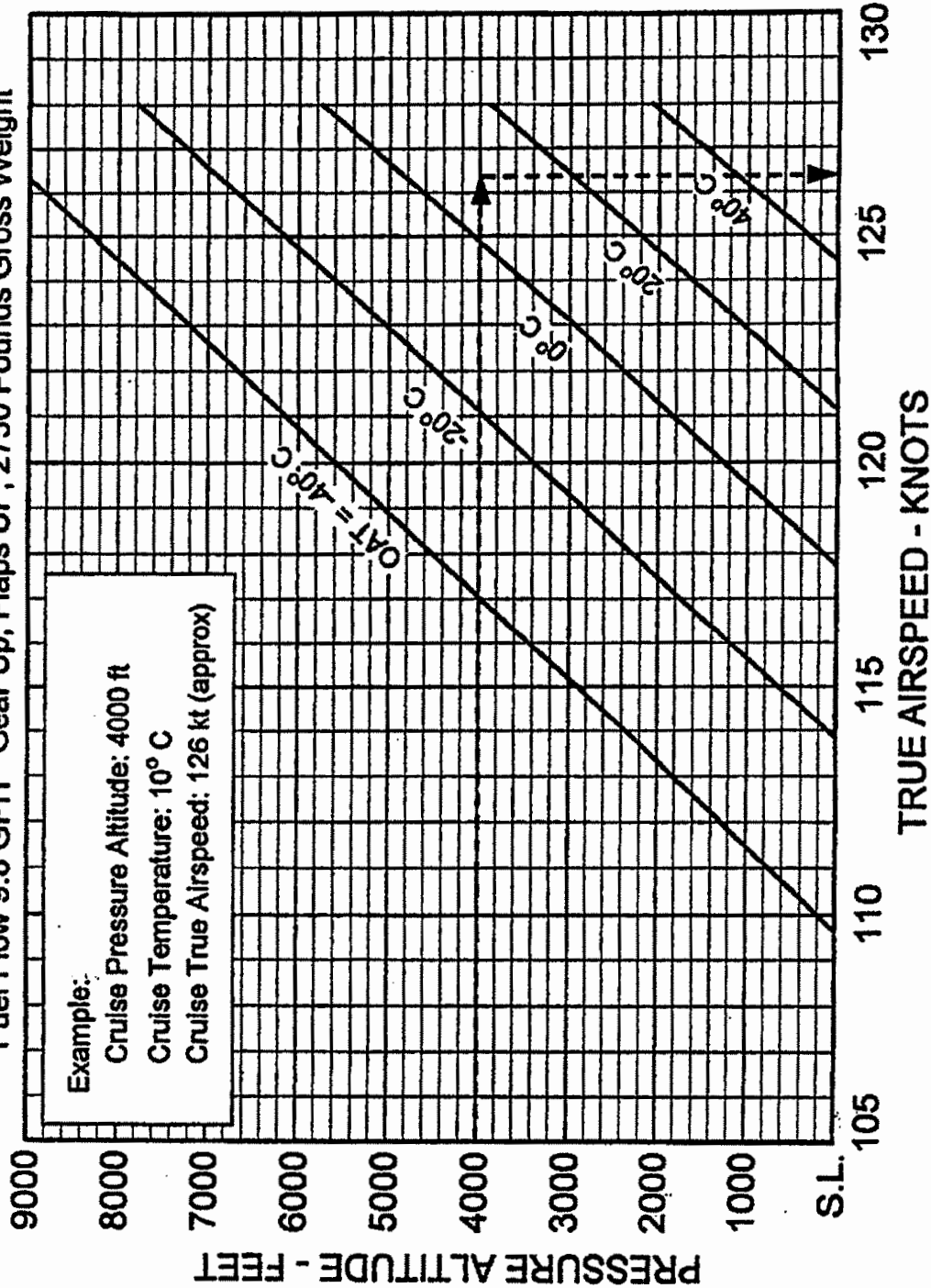

**ECONOMY CRUISE (65% Power 2200 RPM)**

Figure 5-27b

**ECONOMY CRUISE 65% POWER**

MIXTURE: PEAK EGT CRUISE RPM: 2500  
Fuel Flow 10.3 GPH Gear Up, Flaps UP, 2750 Pounds Gross Weight

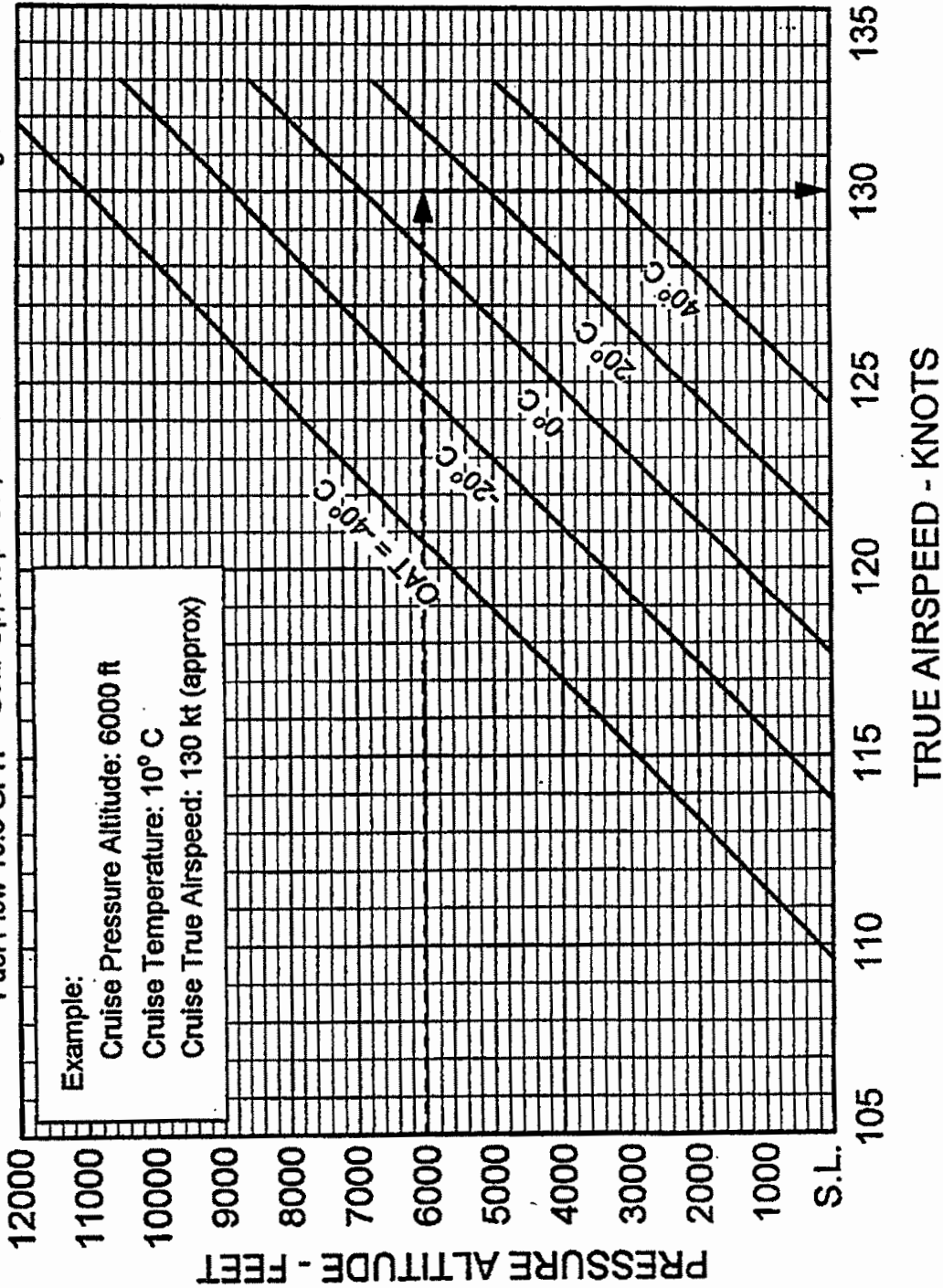

**ECONOMY CRUISE (65% Power 2500 RPM)**

Figure 5-27c

**THIS PAGE INTENTIONALLY LEFT BLANK**

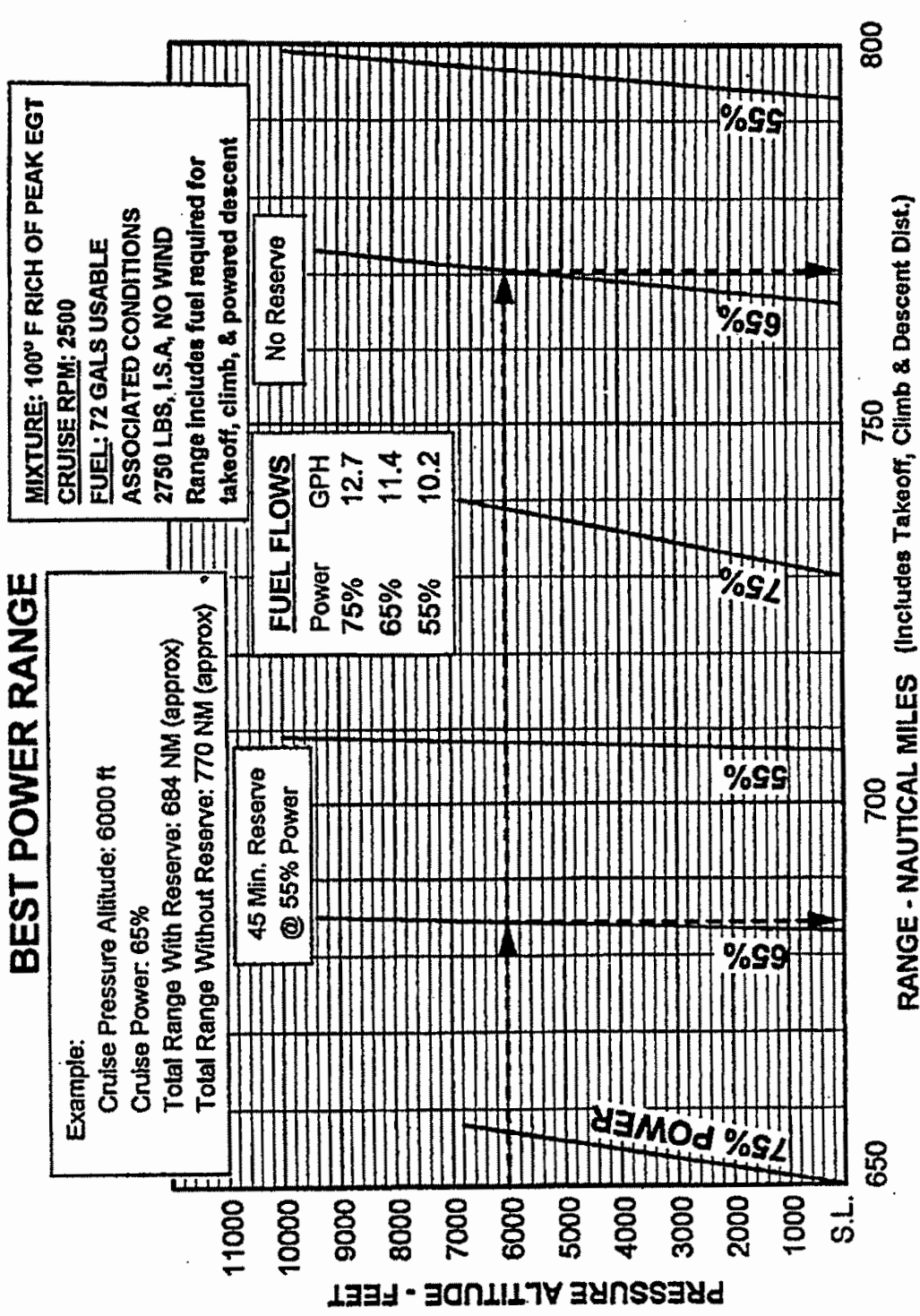

**RANGE - NAUTICAL MILES** (Includes Takeoff, Climb & Descent Dist.)  
 Note: Add 1.5 N.M. for each 10° C above I.S.A.; Subtract 1.5 N.M. for each 10° C below. (Applicable to 75% power only)

**BEST POWER RANGE (2500 RPM)**  
Figure 5-29

**BEST POWER RANGE**

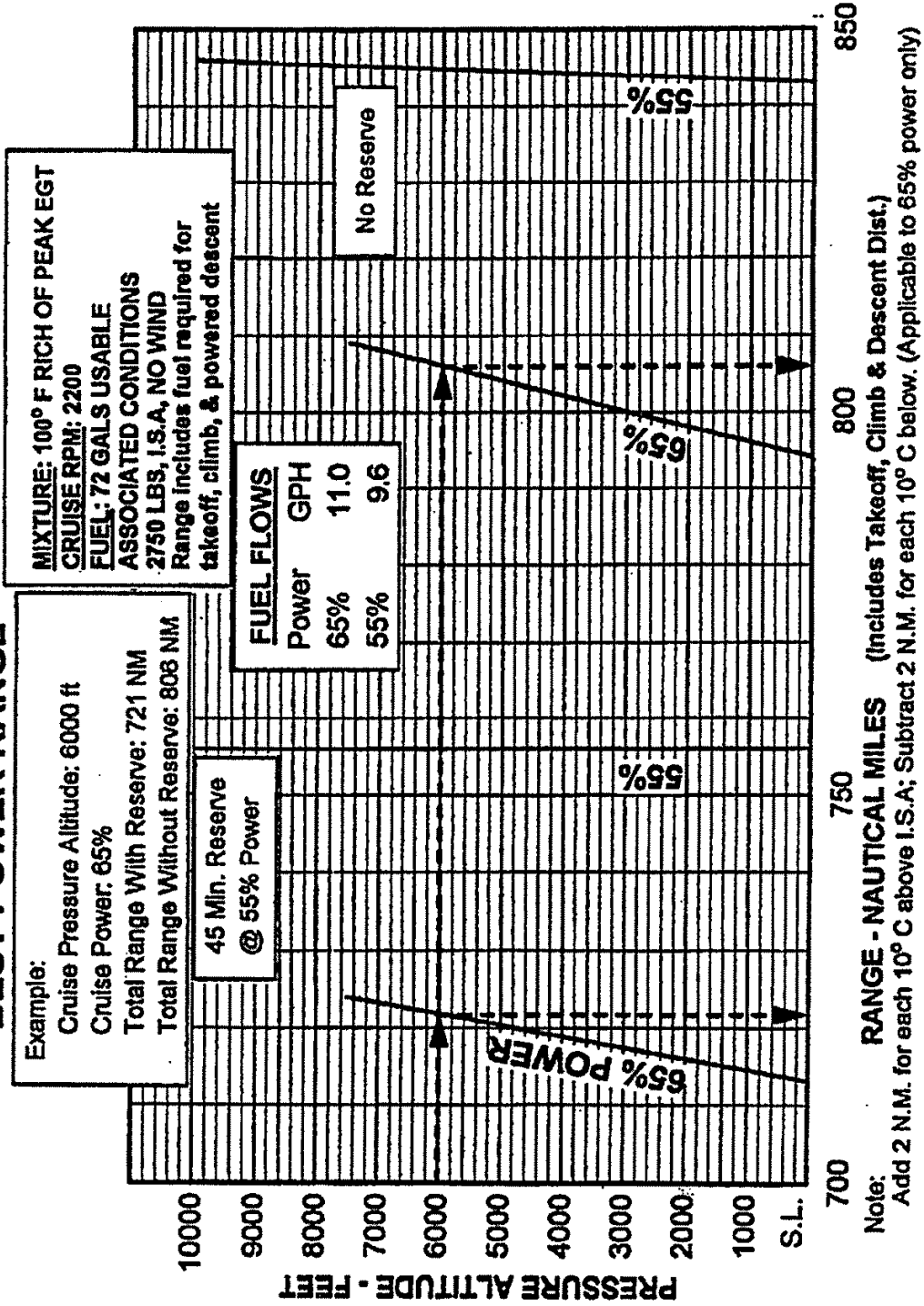

**BEST POWER RANGE (2200 RPM)**

Figure 5-29a





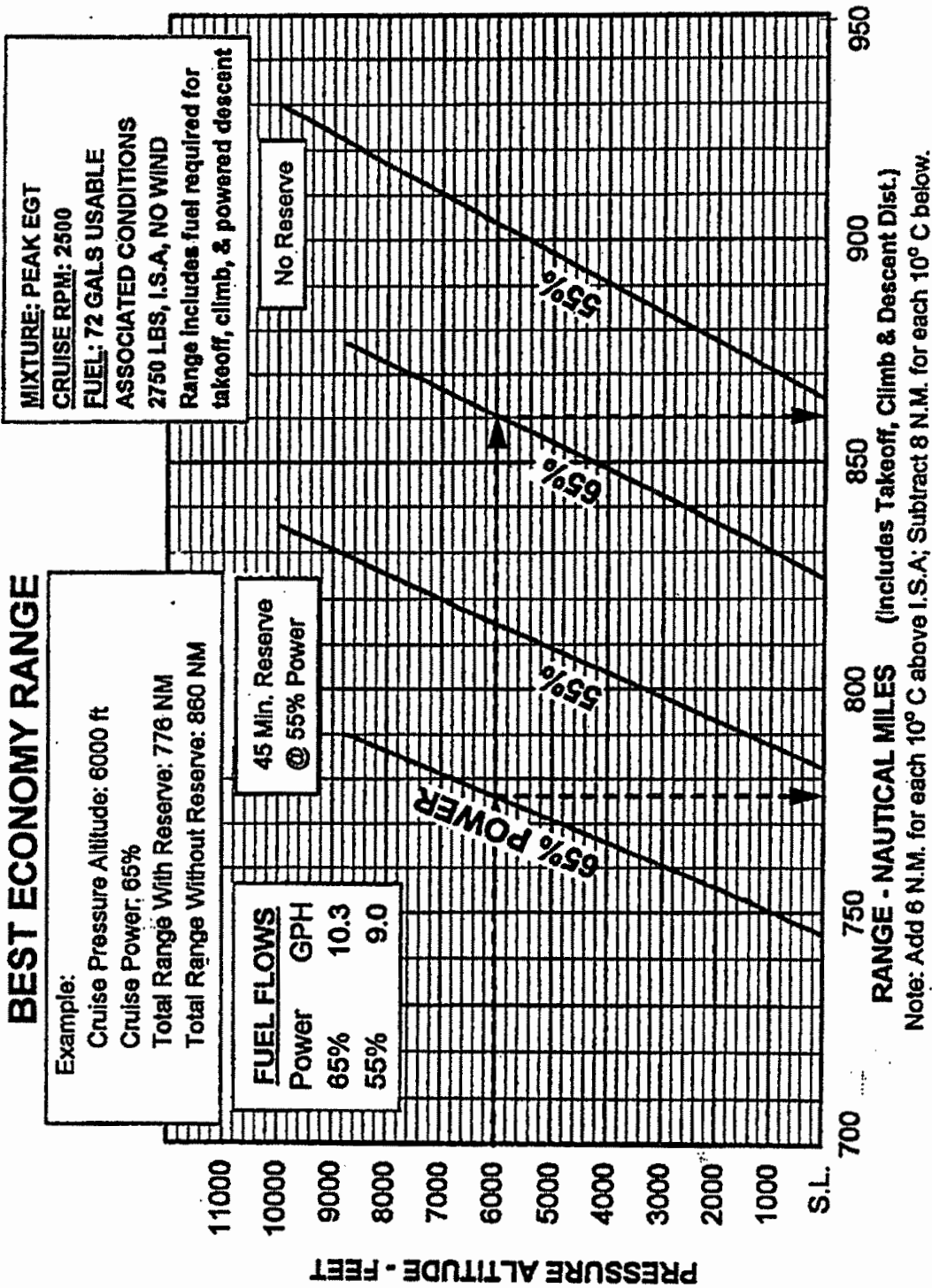
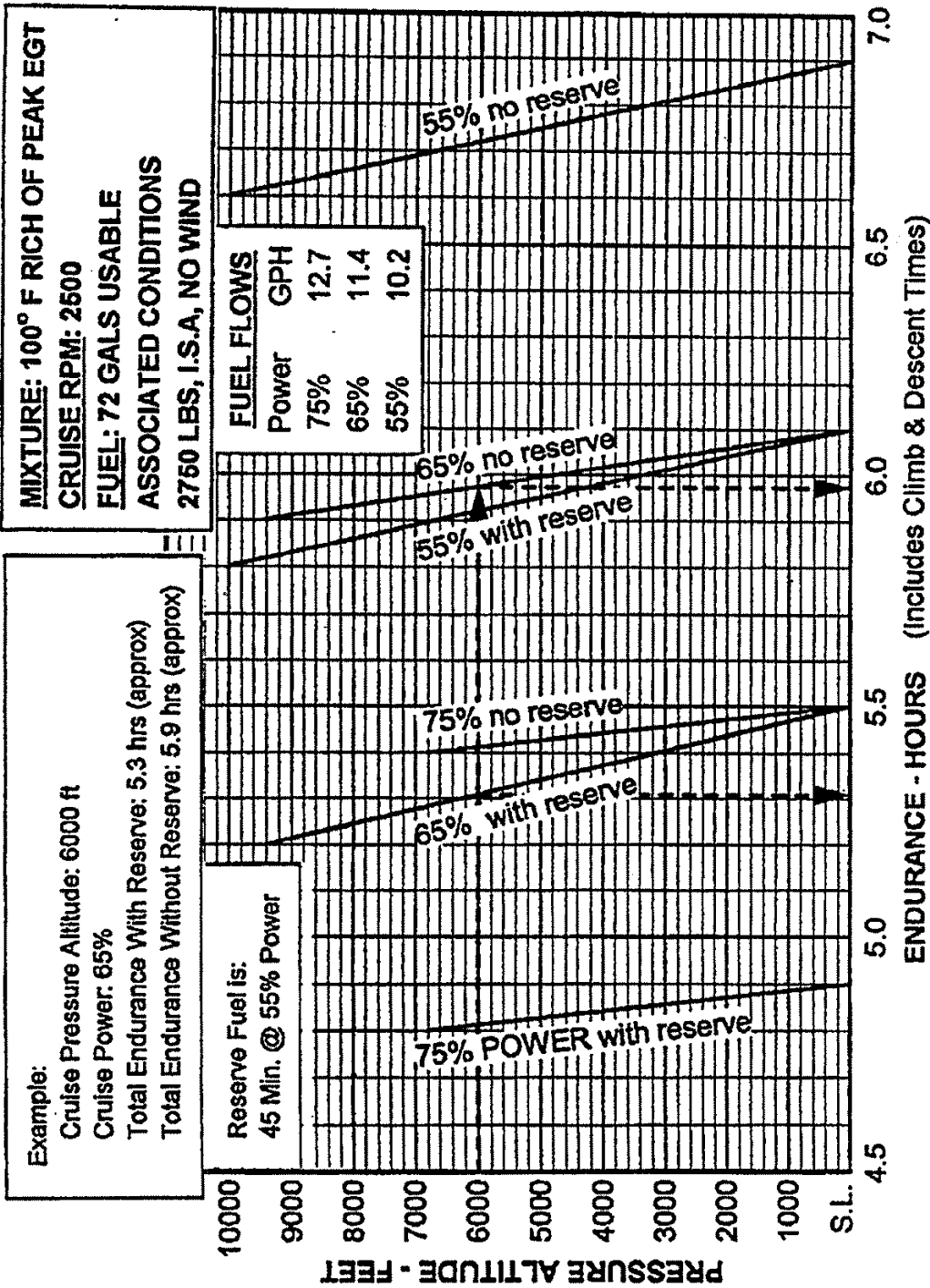

Figure 5-31a

**BEST POWER ENDURANCE**



**BEST POWER ENDURANCE (2500 RPM)**

Figure 5-33

**BEST POWER ENDURANCE**

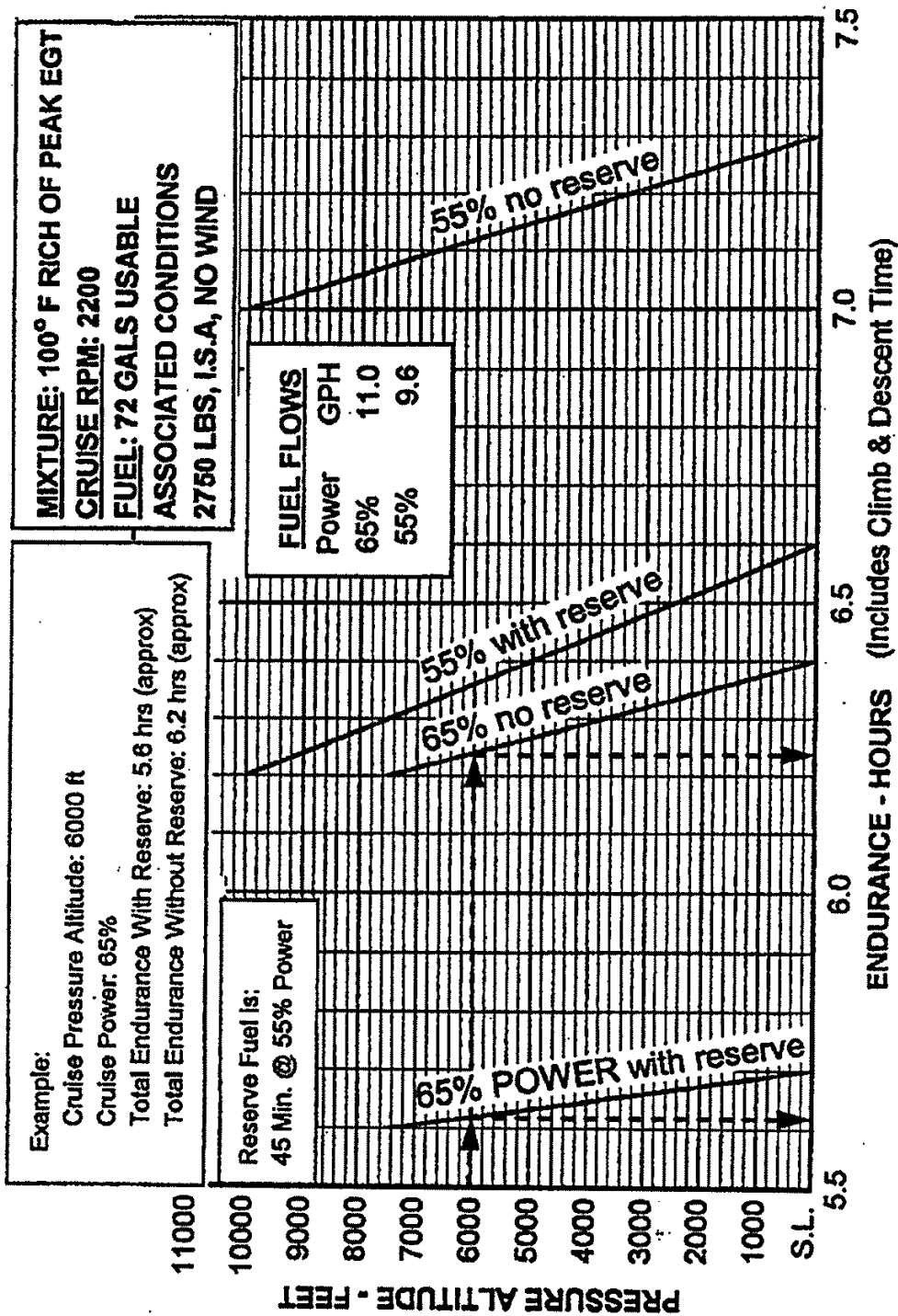

**BEST POWER ENDURANCE (2200 RPM)**

Figure 5-33a

**BEST ECONOMY ENDURANCE**

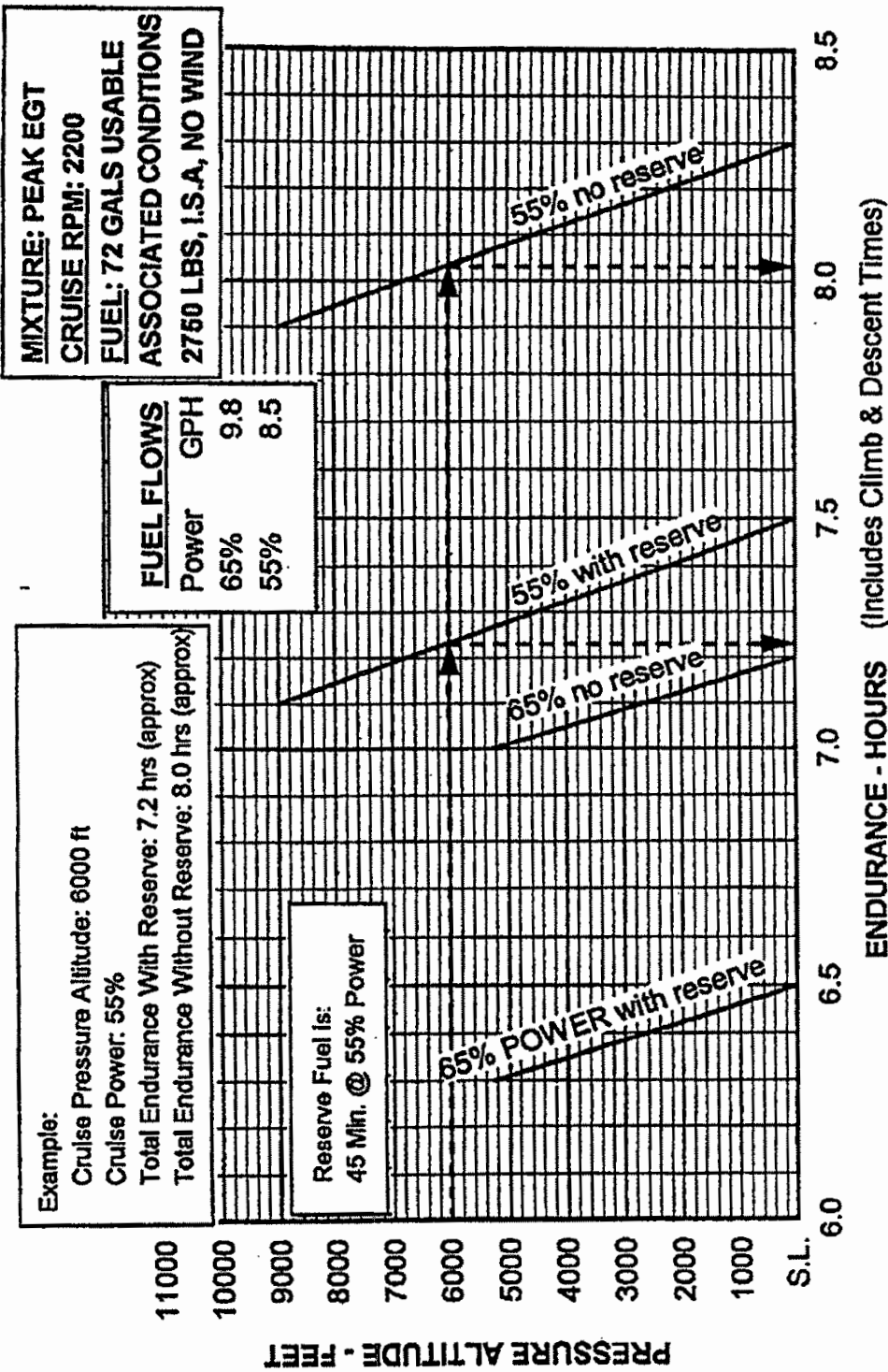

**BEST ECONOMY ENDURANCE (2200 RPM)**

Figure 5-33b

**BEST ECONOMY ENDURANCE**

**MIXTURE: PEAK EGT**  
**CRUISE RPM: 2500**  
**FUEL: 72 GALS USABLE**  
**ASSOCIATED CONDITIONS**  
**2750 LBS, I.S.A, NO WIND**

**Example:**  
 Cruise Pressure Altitude: 6000 ft  
 Cruise Power: 65%  
 Total Endurance With Reserve: 5.9 hrs (approx)  
 Total Endurance Without Reserve: 6.6 hrs (approx)

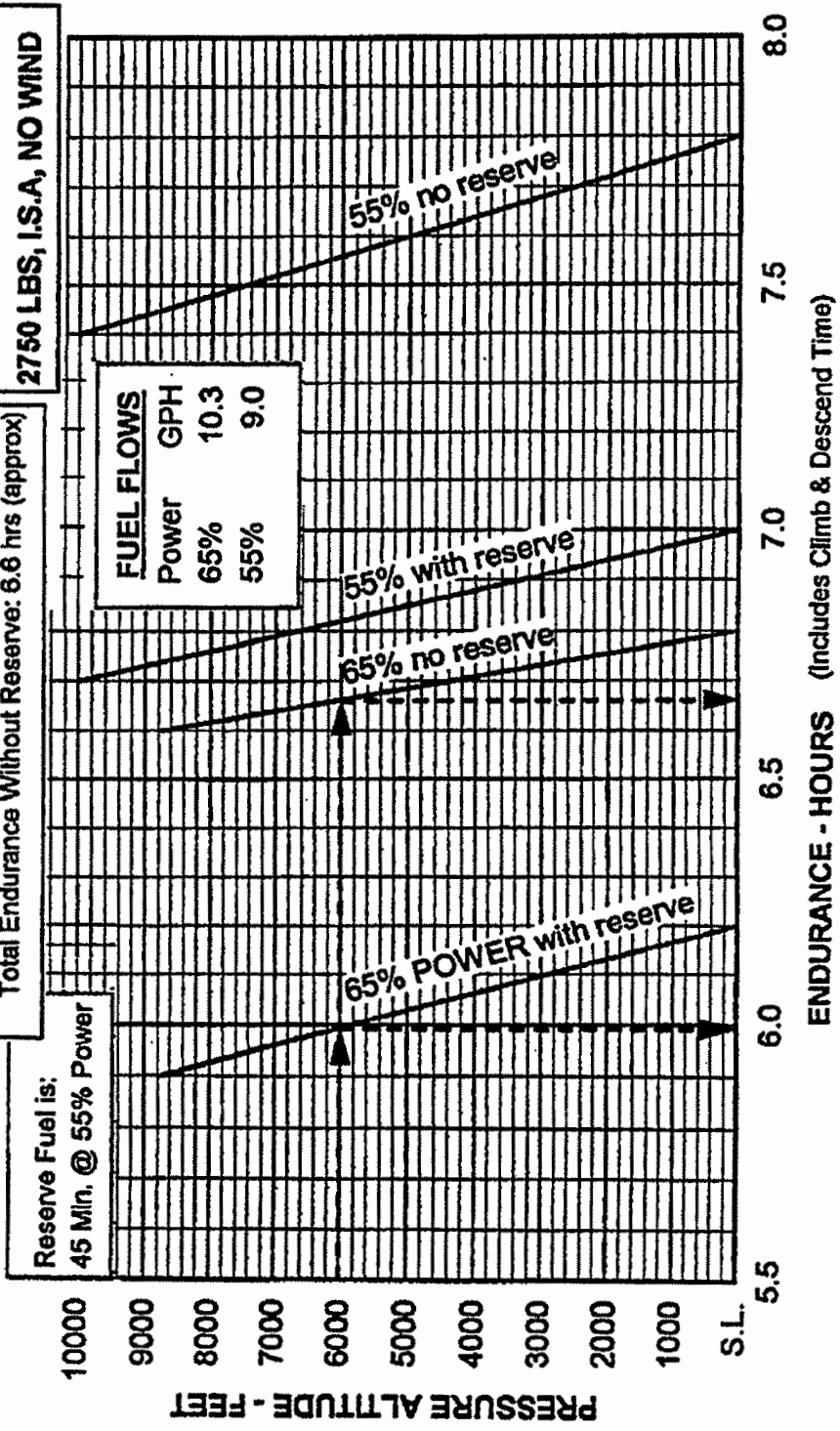

**BEST ECONOMY ENDURANCE (2500 RPM)**  
 Figure 5-33c

**THIS PAGE INTENTIONALLY LEFT BLANK**

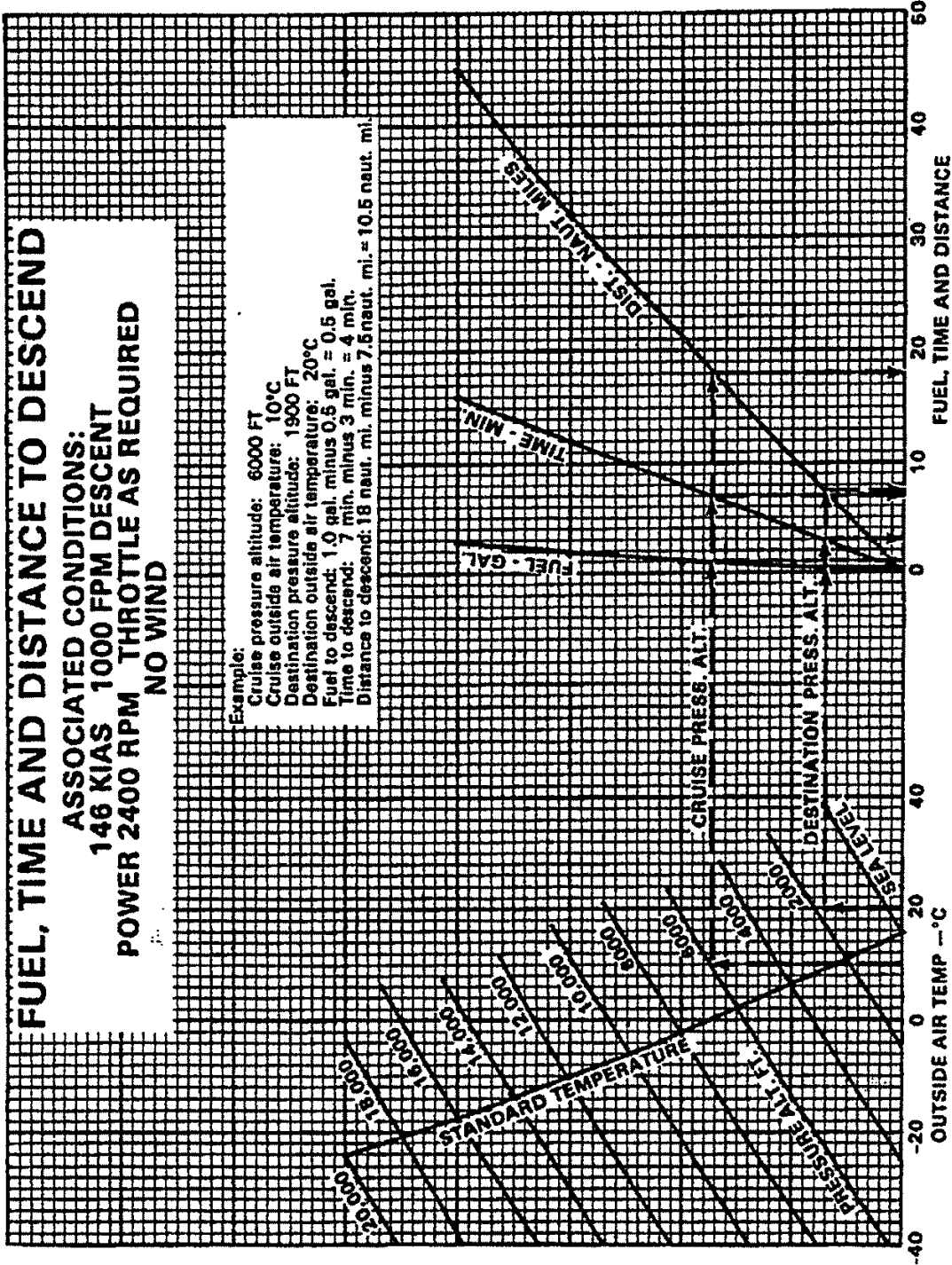

FUEL, TIME AND DISTANCE TO DESCEND

Figure 5-35

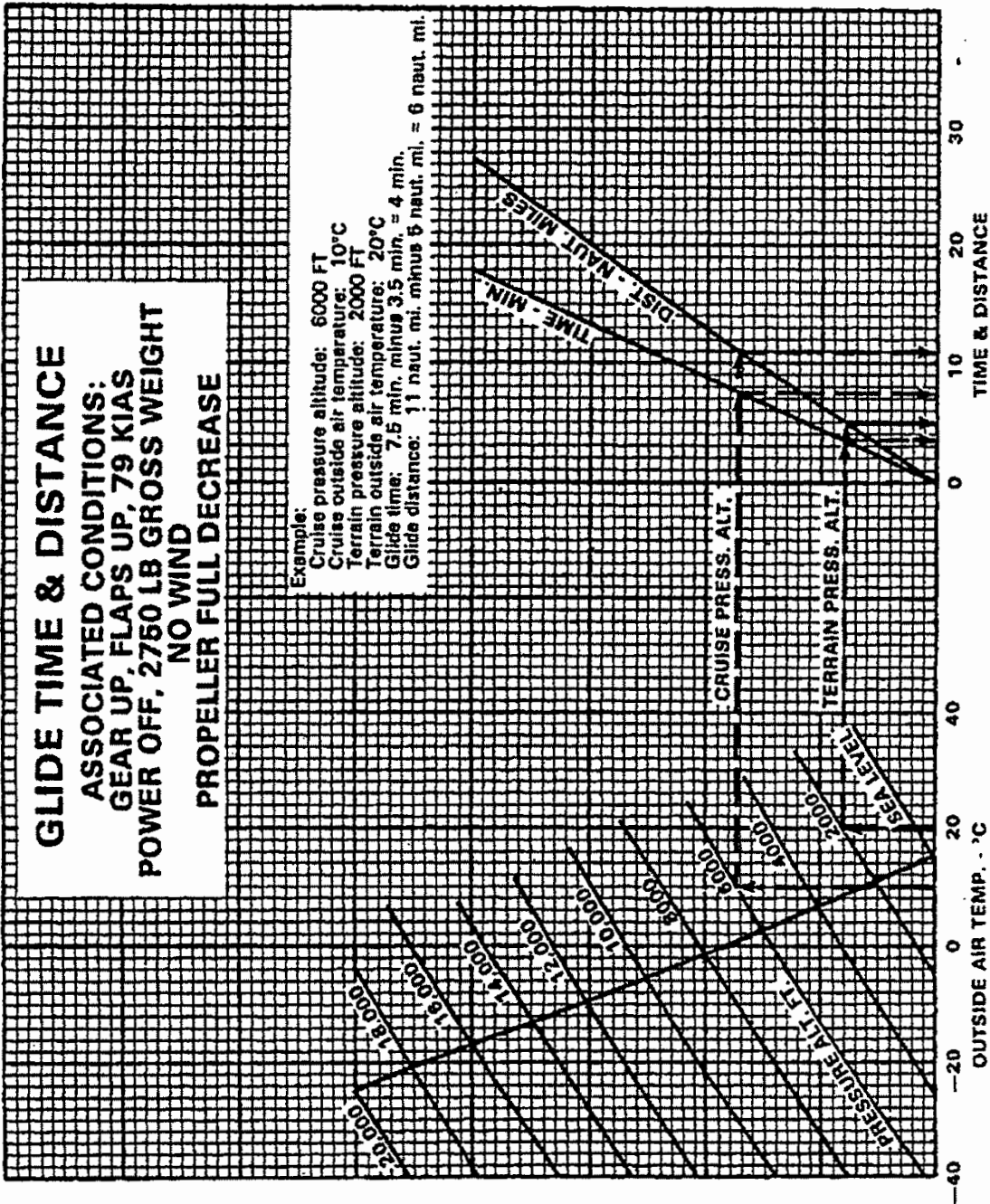

**GLIDE TIME AND DISTANCE**  
Figure 5-37



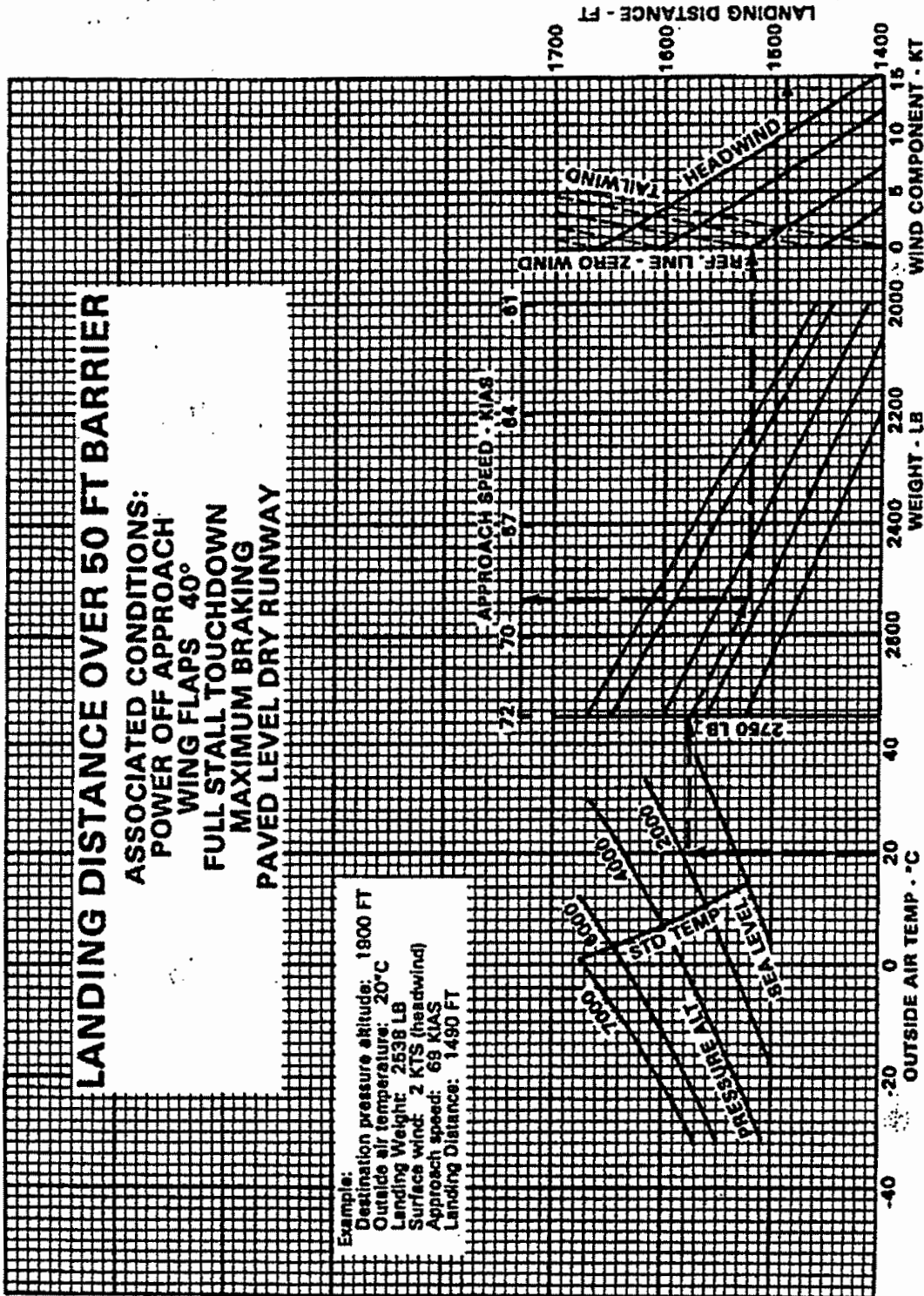

LANDING DISTANCE OVER 50 FOOT BARRIER

Figure 5-39

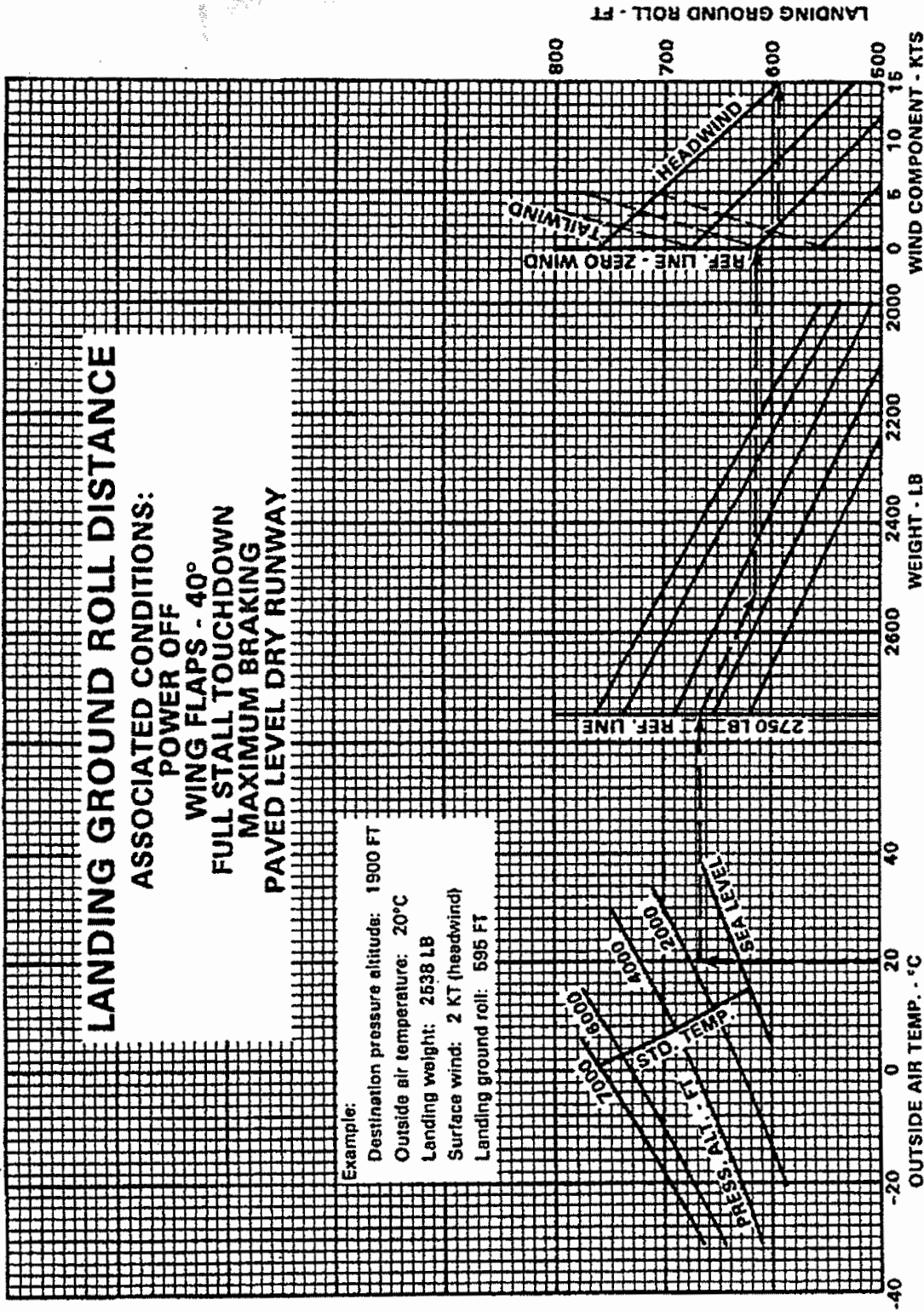

LANDING GROUND ROLL DISTANCE

Figure 5-41

**THIS PAGE INTENTIONALLY LEFT BLANK**

**TABLE OF CONTENTS**

**SECTION 6**

**WEIGHT AND BALANCE**

| <b>Paragraph<br/>No.</b> |   | <b>Page<br/>No.</b>                 |
|--------------------------|---|-------------------------------------|
| 6.1                      | General .....                                     | 6-1                                 |
| 6.3                      | Airplane Weighing Procedure .....                 | 6-2                                 |
| 6.5                      | Weight and Balance Data and Record .....          | 6-5                                 |
| 6.7                      | Weight and Balance Determination for Flight ..... | 6-9                                 |
|                          | Equipment List (Form 240-0129).....               | Supplied with<br>aircraft paperwork |

**THIS PAGE INTENTIONALLY LEFT BLANK**

**SECTION 6  
WEIGHT AND BALANCE**

**6.1 GENERAL**

In order to achieve the performance and flying characteristics which are designed into the airplane, it must be flown with the weight and center of gravity (C.G.) position within the approved operating range (envelope). Although the airplane offers a tremendous flexibility of loading, it cannot be flown with the maximum number of adult passengers, full fuel tanks and maximum baggage. With the flexibility comes responsibility. The pilot must ensure that the airplane is loaded within the loading envelope before he makes a takeoff.

Misloading carries consequences for any aircraft. An overloaded airplane will not take off, climb or cruise as well as a properly loaded one. The heavier the airplane is loaded, the less climb performance it will have.

Center of gravity is a determining factor in flight characteristics. If the C.G. is too far forward in any airplane, it may be difficult to rotate for takeoff or landing. If the C.G. is too far aft, the airplane may rotate prematurely on takeoff or tend to pitch up during climb. Longitudinal stability will be reduced. This can lead to inadvertent stalls and even spins; and spin recovery becomes more difficult as the center of gravity moves aft of the approved limit.

A properly loaded airplane, however, will perform as intended. Before the airplane is delivered, it is weighed, and a basic empty weight and C.G. location is computed (basic empty weight consists of the standard empty weight of the airplane plus the optional equipment). Using the basic empty weight and C.G. location, the pilot can easily determine the weight and C.G. position for the loaded airplane by computing the total weight and moment and then determining whether they are within the approved envelope.

### **6.1 GENERAL (continued)**

The basic empty weight and C.G. location are recorded in the Weight and Balance Data Form (Figure 6-5) and the Weight and Balance Record (Figure 6-7). The current values should always be used. Whenever new equipment is added or any modification work is done, the mechanic responsible for the work is required to compute a new basic empty weight and C.G. position and to write these in the Aircraft Logbook and the Weight and Balance Record. The owner should make sure that it is done.

A weight and balance calculation is necessary in determining how much fuel or baggage can be boarded so as to keep within allowable limits. Check calculations prior to adding fuel to ensure against improper loading.

The following pages are forms used in weighing an airplane in production and in computing basic empty weight, C.G. position, and useful load. Note that the useful load includes usable fuel, baggage, cargo and passengers. Following this is the method for computing takeoff weight and C.G.

### **6.3 AIRPLANE WEIGHING PROCEDURE**

At the time of licensing, Piper provides each airplane with the basic empty weight and center of gravity location. This data is supplied by Figure 6-5.

The removal or addition of equipment or airplane modifications can affect the basic empty weight and center of gravity. The following is a weighing procedure to determine this basic empty weight and center of gravity location:

#### **(a) Preparation**

- (1) Be certain that all items checked in the airplane equipment list are installed in the proper location in the airplane.
- (2) Remove excessive dirt, grease, moisture, foreign items such as rags and tools from the airplane before weighing.
- (3) Defuel airplane. Then open all fuel drains until all remaining fuel is drained. Operate engine on each tank until all undrainable fuel is used and engine stops. Then add the unusable fuel (5.0 gallons total, 2.5 gallons each wing).

**6.3 AIRPLANE WEIGHING PROCEDURE (continued)****CAUTION**

Whenever the fuel system is completely drained and fuel is replenished it will be necessary to run the engines for a minimum of 3 minutes at 1000 rpm on each tank to insure no air exists in the fuel supply lines.

- (4) Fill with oil to full capacity.
- (5) Place pilot and copilot seats in fourth (4th) notch, aft of forward position. Put flaps in the fully retracted position and all control surfaces in the neutral position. Tow bar should be in the proper location and all entrance and baggage doors closed.
- (6) Weigh the airplane inside a closed building to prevent errors in scale readings due to wind.

**(b) Leveling**

- (1) With airplane on scales, block main gear oleo pistons in the fully extended position.
- (2) Level airplane (refer to Figure 6-3) deflating nose wheel tire, to center bubble on level.

**(c) Weighing - Airplane Basic Empty Weight**

- (1) With the airplane level and brakes released, record the weight shown on each scale. Deduct the tare, if any, from each reading.



6.3 AIRPLANE WEIGHING PROCEDURE (continued)

| Scale Position and Symbol          | Scale Reading | Tare | Net Weight |
|------------------------------------|---------------|------|------------|
| Nose Wheel (N)                     |               |      |            |
| Right Main Wheel (R)               |               |      |            |
| Left Main Wheel (L)                |               |      |            |
| Basic Empty Weight, as Weighed (T) |               |      |            |

WEIGHING FORM

Figure 6-1

(d) Basic Empty Weight Center of Gravity

- (1) The following geometry applies to the PA-28R-201 airplane when it is level. Refer to Leveling paragraph 6.3 (b).

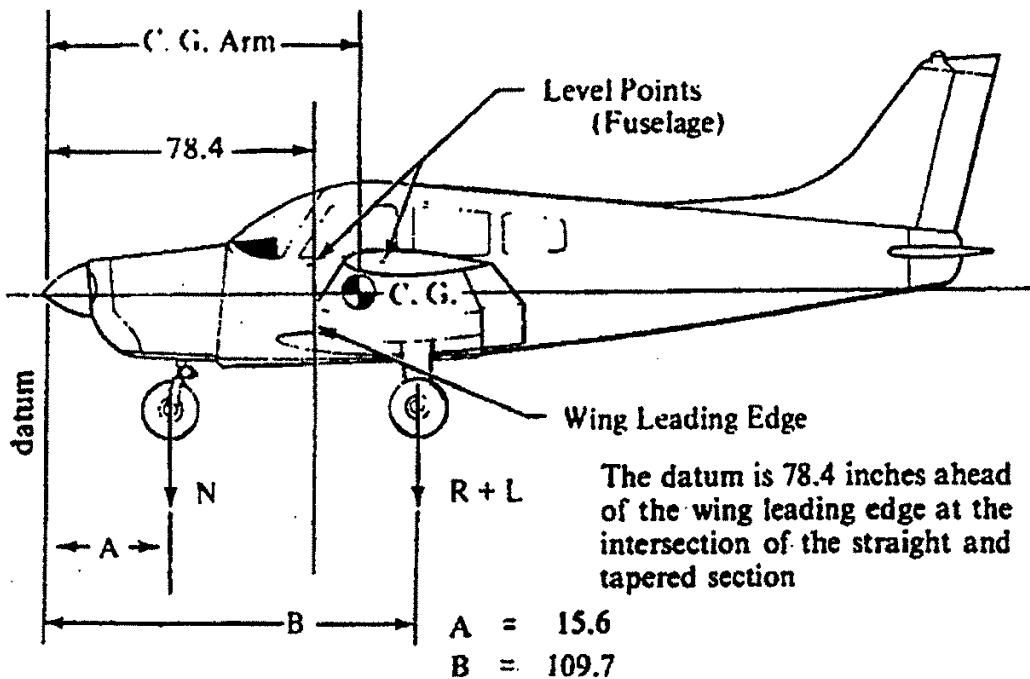

LEVELING DIAGRAM

Figure 6-3

**6.3 AIRPLANE WEIGHING PROCEDURE (continued)**

- (2) The basic empty weight center of gravity (as weighed including optional equipment, full oil and unusable fuel) can be determined by the following formula:

$$\text{C.G. Arm} = \frac{N(A) + (R + L)(B)}{T} \quad \text{inches}$$

Where:  $T = N + R + L$

**6.5 WEIGHT AND BALANCE DATA AND RECORD**

The Basic Empty Weight, Center of Gravity Location and Useful Load listed in Figure 6-5 are for the airplane as licensed at the factory. These figures apply only to the specific airplane serial number and registration number shown.

The basic empty weight of the airplane as licensed at the factory has been entered in the Weight and Balance Record (Figure 6-7). This form is provided to present the current status of the airplane basic empty weight and a complete history of previous modifications. Any change to the permanently installed equipment or modification which affects weight or moment must be entered in the Weight and Balance Record.

**6.5 WEIGHT AND BALANCE DATA AND RECORD (continued)**

MODEL PA-28R-201 ARROW

Airplane Serial Number      **2844120**  
 Registration Number         **HB-Poy**  
    **N30645-**  
 Date                                 **04/28/05**

**AIRPLANE BASIC EMPTY WEIGHT**

| Item   | Weight (Lbs)  | x C.G. Arm (Inches Aft of Datum) | = Moment (In-Lbs) |
|--|---------------|----------------------------------|-------------------|
| Standard Empty Weight* <del>Computed</del> <b>Actual</b> | <b>1797.0</b> | <b>85.8819</b>                   | <b>154329.8</b>   |
| Optional Equipment                                       | <b>65.5</b>   | <b>124.3695</b>                  | <b>8146.2</b>     |
| Basic Empty Weight                                       | <b>1862.5</b> | <b>87.2354</b>                   | <b>162476.0</b>   |

\*The standard empty weight includes full oil capacity and 5.0 gallons of unusable fuel.

**AIRPLANE USEFUL LOAD - NORMAL CATEGORY OPERATION**

(Gross Weight) - (Basic Empty Weight) = Useful Load

(2750 lbs) - ( **1862.5** lbs) = **887.5** lbs.

THIS BASIC EMPTY WEIGHT, C.G. AND USEFUL LOAD ARE FOR THE AIRPLANE AS LICENSED AT THE FACTORY. REFER TO APPROPRIATE AIRCRAFT RECORD WHEN ALTERATIONS HAVE BEEN MADE.

**WEIGHT AND BALANCE DATA FORM**

Figure 6-5

6.5 WEIGHT AND BALANCE DATA AND RECORD (continued)

HB-PQY

| PA-28R-201 | Serial Number | 2844120                                | Registration Number N30645 |           |             |             | Page Number |             |
|------------|---------------|--|----------------------------|-----------|-------------|-------------|-------------|-------------|
|            |               |  | Wt. (Lb.)                  | Arm (In.) | Moment /100 | Wt. (Lb.)   | Moment /100 |             |
| Date       | Item No.      | Description of Article or Modification | Added (+)<br>Removed (-)   | Wt. (Lb.) | Arm (In.)   | Moment /100 | Wt. (Lb.)   | Moment /100 |
| 04/28/05   |               | As licensed                            |                            |           |             |             | 1862.5      |             |
| 08/27/07   |               | Inst. Garmin GI-100A                   | +                          | 1.02      | 60.23       | 61.42       | 1863.52     | 162537.43   |
| 03/28/07   |               | MIV-12-B Propeller                     | +/-                        |           |             |             | 1856.02     | 162526.43   |
| 09/20/07   |               | Gromozig MUFFLER                       | +                          | 12.5      | 66          | 825         | 1868.52     | 163371.45   |
| 03/20/07   |               | Flarm                                  | +                          | 1.0       | 57          | 57          | 1869.52     | 163408.48   |
| 05.06.09   |               | Replace ELT by Arlex                   | +/-                        |           |             |             | 1867.82     | 163007.23   |

WEIGHT AND BALANCE RECORD

Figure 6-7

**SECTION 6**

**WEIGHT AND BALANCE**

**PA-28R-201, ARROW**

**6.5 WEIGHT AND BALANCE DATA AND RECORD (continued)**

| PA-28R-201 | Date | Item No. | Serial Number                          |                          | Registration Number | Page Number   |                            |
|------------|------|----------|--|--------------------------|---------------------|---------------|----------------------------|
|            |      |          | Description of Article or Modification | Added (+)<br>Removed (-) |                     | Weight Change | Running Basic Empty Weight |
|            |      |          |  |                          |                     | Wt. (Lb.)     | Moment /100                |
|            |      |          |  |                          |                     | Arm (In.)     | Moment /100                |
|            |      |          |  |                          |                     | Wt. (Lb.)     | Moment /100                |

**WEIGHT AND BALANCE RECORD (cont)**

Figure 6-7 (cont)

**6.7 WEIGHT AND BALANCE DETERMINATION FOR FLIGHT**

- (a) Add the weight of all items to be loaded to the basic empty weight.
- (b) Use the Loading Graph (Figure 6-13) to determine the moment of all items to be carried in the airplane.
- (c) Add the moment of all items to be loaded to the basic empty weight moment.
- (d) Divide the total moment by the total weight to determine the C.G. location.
- (e) By using the figures of item (a) and item (d) (above), locate a point on the C.G. range and weight graph (Figure 6-15). If the point falls within the C.G. envelope, the loading meets the weight and balance requirements.

|  | Weight<br>(Lbs) | Arm Aft<br>Datum<br>(Inches) | Moment<br>(In-Lbs) |
|--|-----------------|------------------------------|--------------------|
| Basic Empty Weight                                   | 1890            | 84.8                         | 160272             |
| Pilot and Front Passenger                            | 340.0           | 80.5                         | 27370              |
| Passengers (Rear Seats)                              | 170.0           | 118.1                        | 20077              |
| Fuel (72 Gallons Maximum)                            | 294             | 95.0                         | 27930              |
| Baggage (200 Lbs. Maximum)                           | 64              | 142.8                        | 9139               |
| Ramp Weight (2758 Lbs.<br>Maximum)                   | 2758            | 88.76                        | 244788             |
| Fuel Allowance For Engine<br>Start, Taxi, and Run-Up | -8              | 95.0                         | -760               |
| Moment due to Retraction<br>of Landing Gear          |                 |                              | 819                |
| Takeoff Weight (2750 Lbs.<br>Maximum)                | 2750            | 89.04                        | 244847             |

The center of gravity (C.G.) of this sample loading problem is at 89.04 inches aft of the datum line. Locate this point (89.04) on the C.G. range and weight graph. Since this point falls within the weight - C.G. envelope, this loading meets the weight and balance requirements.

**IT IS THE RESPONSIBILITY OF THE PILOT AND AIRCRAFT OWNER TO ENSURE THAT THE AIRPLANE IS LOADED PROPERLY.**

**SAMPLE LOADING PROBLEM (NORMAL CATEGORY)**

Figure 6-9

**6.7 WEIGHT AND BALANCE DETERMINATION FOR FLIGHT  
(continued)**

|  | Weight<br>(Lbs) | Arm Aft<br>Datum<br>(Inches) | Moment<br>(In-Lbs) |
|--|-----------------|------------------------------|--------------------|
| Basic Empty Weight                                   |                 |                              |                    |
| Pilot and Front Passenger                            |                 | 80.5                         |                    |
| Passengers (Rear Seats)                              |                 | 118.1                        |                    |
| Fuel (72 Gallons Maximum)                            |                 | 95.0                         |                    |
| Baggage (200 Lbs. Maximum)                           |                 | 142.8                        |                    |
| Ramp Weight (2758 Lbs.<br>Maximum)                   |                 |                              |                    |
| Fuel Allowance For Engine<br>Start, Taxi, and Run-Up | -8              | 95.0                         | -760               |
| Moment due to Retraction<br>of Landing Gear          |                 |                              | 819                |
| Takeoff Weight (2750 Lbs.<br>Maximum)                |                 |                              |                    |

Totals must be within approved weight and C.G. limits. It is the responsibility of the airplane owner and the pilot to insure that the airplane is loaded properly. The Basic Empty Weight C.G. is noted on the Weight and Balance Data Form (Figure 6-5). If the airplane has been altered, refer to the Weight and Balance Record for this information.

**WEIGHT AND BALANCE LOADING FORM**  
Figure 6-11

6.7 WEIGHT AND BALANCE DETERMINATION FOR FLIGHT  
(continued)

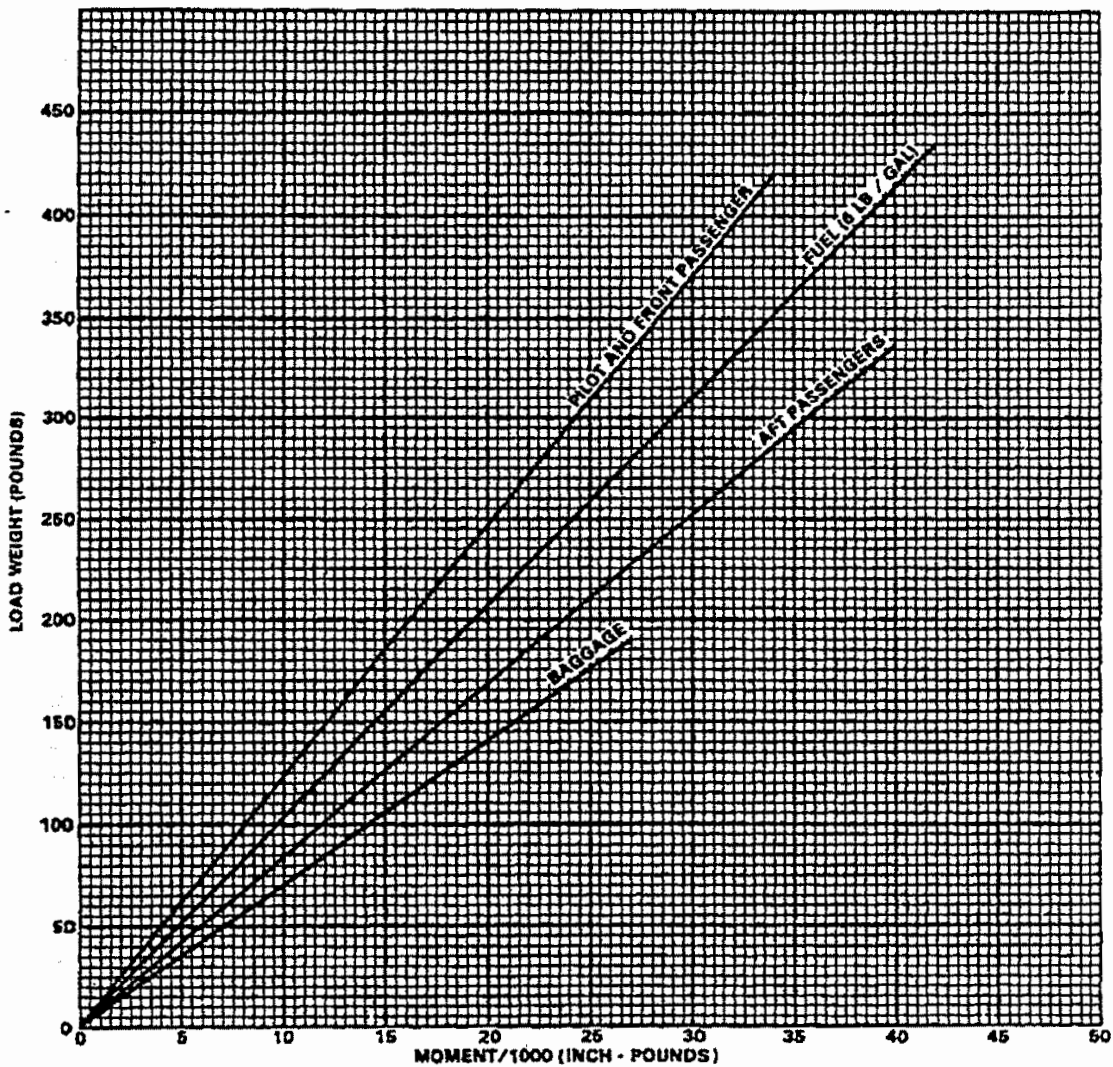

LOADING GRAPH  
Figure 6-13



6.7 WEIGHT AND BALANCE DETERMINATION FOR FLIGHT  
(continued)

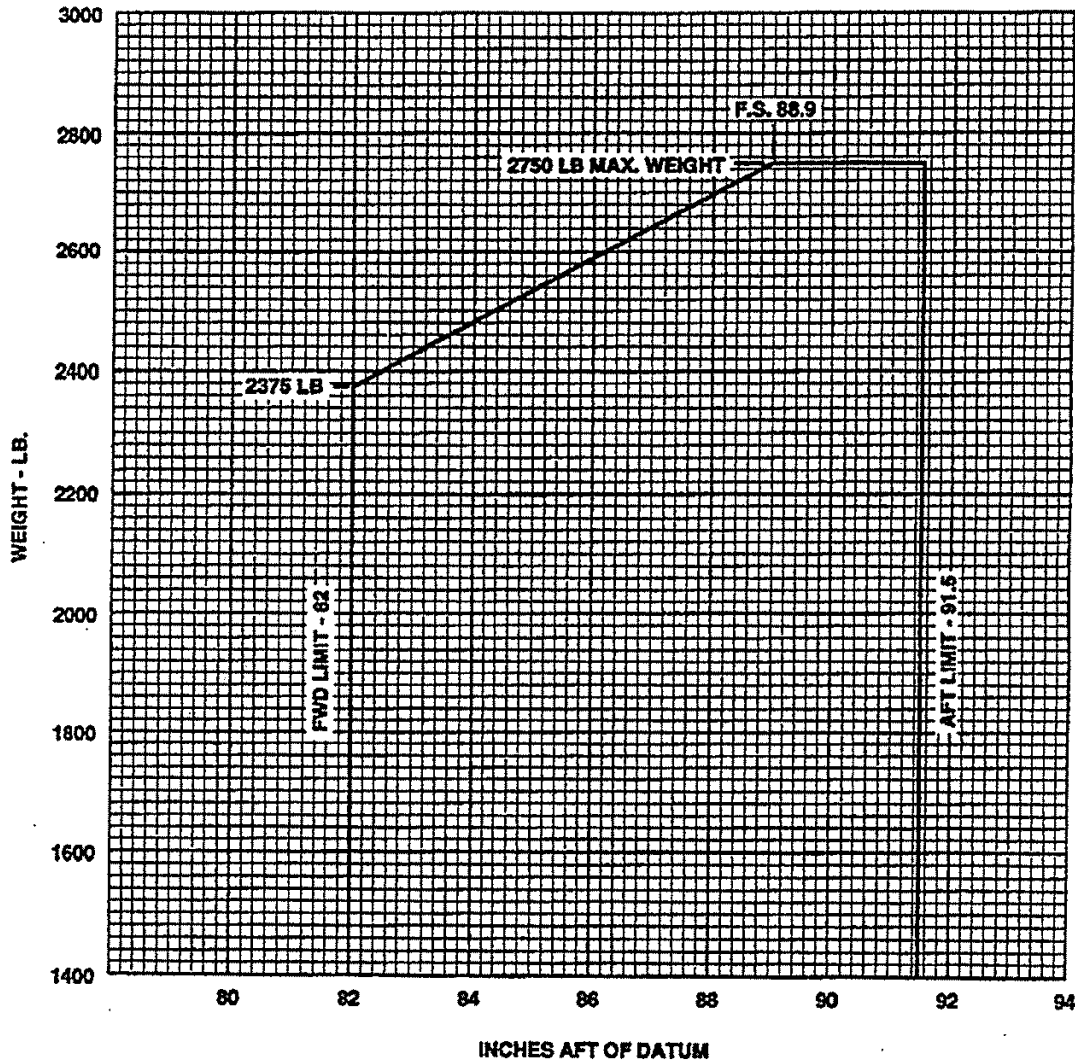

C. G RANGE AND WEIGHT  
Figure 6-15



THE NEW PIPER AIRCRAFT, INC

PA-28R-201, ARROW  
EQUIPMENT LIST  
S/N 2844116 and UP

EQUIPMENT LIST

The following is a list of standard and optional equipment for the PA-28R-201 Arrow. Optional equipment items marked with an X are installed on the airplane. All items are as described below at the time of licensing by the manufacturer. The New Piper Aircraft, Inc. will not revise this equipment list once the aircraft is licensed. It is the owner's responsibility to retain and amend this equipment list to reflect changes in equipment installed in this airplane.

Unless otherwise indicated, the installation certification basis for the equipment included in this list is the aircraft's approved type design.

THE NEW PIPER AIRCRAFT, INC.

PA-28R-201, ARROW

SERIAL NO. 2844120

REGISTRATION NO. N30645

DATE 04/28/05

*HB-POY*

| Item No.                        | Item  | Weight (Pounds) | Arm (In.) Aft Datum | Moment (Lb-In.) |
|---------------------------------|---|-----------------|---------------------|-----------------|
| (a) Electrical Equipment        |   |                 |                     |                 |
| 1                               | Battery- 12V, 35 Amp Hour, Piper drawing 104346-003, Piper PS50133 and Piper code number 450-035      | 27.20           | 168.00              | 4569.60         |
| (b) Cabin Interior              |   |                 |                     |                 |
| 11                              | Pilot Seat (Vinyl/cloth), Piper drawing 89023-2   | 22.39           | 83.00               | 1858.37         |
| 13                              | Copilot Seat (Vinyl/cloth), Piper drawing 89023-3   | 22.62           | 82.80               | 1872.94         |
| 15                              | Aft Rear Seat (Vinyl/cloth) (right), Piper drawing 89027-3  | 13.99           | 123.00              | 1720.77         |
| 17                              | Aft Rear Seat (Vinyl/cloth) (left), Piper drawing 89027-2   | 13.93           | 123.00              | 1713.39         |
| (c) Standard Avionics Equipment |   |                 |                     |                 |
| 21                              | Pilot's Microphone, Piper drawing 79036-024   |                 |                     |                 |
|                                 | a.) Telex 100T/NH Microphone 62800-001, Piper code number 474-657                                     | 0.26            | 74.13               | 19.35           |
|                                 | b.) Telex Holder 64022-000 and Hardware, Piper drawing 79036-024                                      | 0.03            | 74.13               | 2.34            |
| 23                              | Pilot's Headset, Piper drawing 79036-024  |                 |                     |                 |
|                                 | a.) Telex 5161A Airman 760 Headset, Piper code number 692-205   | 0.20            | 80.5                | 16.34           |
| (d) Miscellaneous               |   |                 |                     |                 |
| 41                              | Fire Extinguisher installation, Piper drawing 82235-2   |                 |                     |                 |
|                                 | a.) Saber part number 1211-1301 Halon Model RTA600, Piper drawing 100632-2, Piper code number 459-887 | 1.62            | 98.44               | 159.03          |
|                                 | b.) Fire extinguisher installation hardware, Piper drawing 82235-2                                    | 0.56            | 98.49               | 55.12           |
| 43                              | Fuel sampler bottle, Piper drawing 67728-0  | 0.07            | 64.42               | 4.48            |



THE NEW PIPER AIRCRAFT, INC

PA-28R-201, ARROW  
EQUIPMENT LIST  
S/N 2844116 and UP

| Item No.                    | Item                           | Weight (Pounds) | Arm (In.) Aft Datum | Moment (Lb-In.) |
|-----------------------------|--------------------------------|-----------------|---------------------|-----------------|
| (d) Miscellaneous-continued |                                |                 |                     |                 |
| 45                          | Tow Bar, Piper drawing 67336-0 | 2.20            | 156.00              | 343.20          |

**END OF STANDARD EQUIPMENT**

---



THE NEW PIPER AIRCRAFT, INC

PA-28R-201, ARROW  
EQUIPMENT LIST  
S/N 2844116 and UP

| Item No.                                 | Item  | Mark if Option Installed            | Weight (Pounds) | Arm (In.) Aft Datum | Moment (Lb-In.) |
|--|---|-------------------------------------|-----------------|---------------------|-----------------|
| <b>(e) Optional Electrical Equipment</b> |   |                                     |                 |                     |                 |
| 71                                       | Tail Light installation, Piper drawing 104296-007, (Non –Avidyne Entegra), United Kingdom lighting requirement, (Marketing Option 363)              |                                     |                 |                     |                 |
|  | a.) Light assembly, Piper drawing 63886-000   | <input type="checkbox"/>            | 0.14            | 280.90              | 39.13           |
|  | b.) Tail light installation hardware, Piper drawing 104296-007  | <input type="checkbox"/>            | 0.19            | 229.92              | 42.68           |
|  | Tail Light installation total weight  |                                     | 0.33            | 247.91              | 81.81           |
| 73                                       | Tail Light installation, Piper drawing 104296-012, Avidyne Entegra System (only), United Kingdom lighting requirement, (Marketing Option 363)       |                                     |                 |                     |                 |
|  | a.) Light assembly, Piper drawing 63886-000   | <input checked="" type="checkbox"/> | 0.14            | 280.90              | 39.13           |
|  | b.) Tail light installation hardware, Piper drawing 104296-012  | <input checked="" type="checkbox"/> | 0.068           | 273.04              | 18.65           |
|  | Tail Light installation total weight  |                                     | 0.21            | 278.313             | 57.78           |
| 75                                       | Tail Strobe installation, Piper drawing 104296-005, (Marketing Option 355)  |                                     |                 |                     |                 |
|  | a. Strobe Light, Whelen 01-0790111-02, Piper code number 683-504  | <input type="checkbox"/>            | 0.24            | 243.79              | 58.63           |
|  | b. Cables/harnesses and hardware, Piper drawing 104296-005  | <input type="checkbox"/>            | 1.29            | 194.95              | 251.92          |
|  | Tail Strobe installation total weight   |                                     | 1.53            | 202.61              | 310.55          |
| <del>77</del>                            | <del>Wing Tip Recognition lights, Piper drawing 87487-0, (Marketing Option 369)</del>   |                                     |                 |                     |                 |
|  | a.) Lamp assembly-left wing, Whelen model A775-50-14, Piper drawing 87742-002, Piper code number 572-579  | <input type="checkbox"/>            | 0.13            | 94.08               | 12.56           |
|  | b.) Lamp assembly-left wing, Whelen model A775-50-14, Piper drawing 87742-002, Piper code number 572-579  | <input type="checkbox"/>            | 0.13            | 94.08               | 12.56           |
|  | c.) Wing Tip recognition light installation hardware, Piper drawing 87487-008   | <input type="checkbox"/>            | 1.36            | 97.90               | 132.75          |
|  | Wing Tip Recognition Light installation total weight  |                                     | 1.62            | 97.27               | 157.87          |
| <b>(f) Autopilot optional equipment</b>  |   |                                     |                 |                     |                 |
| 91                                       | S-TEC System 55X Autopilot with Compass STS-180/HSI, Piper drawing 104581-002 or 104581-005, (Marketing Option 594 – requires Marketing Option 595) |                                     |                 |                     |                 |
|  | a.) S-TEC Turn Coordinator, Part number 6405-14L  | <input type="checkbox"/>            | 1.62            | 60.4                | 97.546          |
|  | b.) Turn Coordinator hardware, Piper drawing 104581-002 or 104581-005   | <input type="checkbox"/>            | 0.01            | 62.99               | 0.89            |
|  | c.) S-TEC Programmer /Computer, Part number 01192-1-46TP  | <input type="checkbox"/>            | 2.700           | 58.20               | 157.14          |
|  | d.) S-TEC Programmer Computer Bracket and Hardware  | <input type="checkbox"/>            | 0.39            | 58.26               | 22.65           |
|  | e.) S-TEC Transducer, Part number 0111  | <input type="checkbox"/>            | 0.20            | 192.40              | 38.48           |
|  | f.) S-TEC Transducer installation kit   | <input type="checkbox"/>            | 0.13            | 192.40              | 24.38           |
|  | g.) Transducer hardware, Piper drawing 104581-002 or 104581-005   | <input type="checkbox"/>            | 0.118           | 191.2               | 22.62           |
|  | h.) S-TEC Roll Servo, Part number 0105-R9   | <input type="checkbox"/>            | 2.77            | 125.7               | 348.69          |
|  | i.) S-TEC Roll Servo Brackets and Cable   | <input type="checkbox"/>            | 0.59            | 125.7               | 74.10           |
|  | k.) Roll Servo hardware, Piper drawing 104581-002 or 104581-005   | <input type="checkbox"/>            | 0.07            | 119.36              | 8.05            |
|  | l.) S-TEC Pitch Servo, Part number 0107-P4  | <input type="checkbox"/>            | 2.82            | 232.73              | 655.60          |
|  | m.) S-TEC Pitch Servo Bracket part number 60310   | <input type="checkbox"/>            | 0.91            | 232.73              | 210.62          |
|  | n.) Pitch Servo hardware, Piper drawing 104581-002 or 104581-005  | <input type="checkbox"/>            | 0.43            | 238.64              | 101.62          |
|  | o.) S-TEC Trim Servo, Part number 0105-8-T6   | <input type="checkbox"/>            | 2.85            | 160.73              | 458.73          |



THE NEW PIPER AIRCRAFT, INC

PA-28R-201, ARROW  
EQUIPMENT LIST  
S/N 2844116 and UP

| Item No. | Item  | Mark if Option Installed | Weight (Pounds) | Arm (In.) Aft Datum | Moment (Lb-In.) |
|----------|---|--------------------------|-----------------|---------------------|-----------------|
|          | (f) Autopilot optional equipment – continued  |                          |                 |                     |                 |
| 91       | S-TEC System 55X Autopilot with Compass STS-180/HSI (Piper drawing 104581-002 or 104581-005), (Marketing Option 594 – requires Marketing Option 595) –continued               |                          |                 |                     |                 |
|          | p.) S-TEC Trim Servo, Brackets and hardware   | <input type="checkbox"/> | 1.28            | 159.54              | 203.71          |
|          | q.) Trim Servo hardware, Piper drawing 104581-002 or 104581-005   | <input type="checkbox"/> | 0.07            | 158.55              | 11.00           |
|          | r.) S-TEC Monitor/Sonalert, Sonalert, Part number 6551  | <input type="checkbox"/> | 0.10            | 57.5                | 5.75            |
|          | s.) S-TEC Monitor/Sonalert Trim Monitor, Part number 01240  | <input type="checkbox"/> | 0.30            | 57.5                | 17.25           |
|          | t.) S-TEC Trim Monitor and Horn Brackets and hardware   | <input type="checkbox"/> | 0.25            | 58.30               | 14.68           |
|          | u.) S-TEC Potentiometer installation kit  | <input type="checkbox"/> | 0.20            | 119.28              | 23.95           |
|          | v.) Potentiometer Hardware, Piper drawing 104581-002 or 104581-005  | <input type="checkbox"/> | 0.02            | 122.27              | 2.80            |
|          | w.) S-TEC Switch Installation Kit, Part number 90415-7  | <input type="checkbox"/> | 0.07            | 63.04               | 4.11            |
|          | x.) S-TEC Directional Gyro, Part number 6406-28L  | <input type="checkbox"/> | 3.40            | 59.00               | 200.60          |
|          | y.) S-TEC Autopilot Cables 901415-010   | <input type="checkbox"/> | 5.46            | 83.50               | 456.06          |
|          | z.) S-TEC Horizontal Situation Indicator, Part number 6443-PA   | <input type="checkbox"/> | 2.71            | 57.19               | 154.98          |
|          | aa.) S-TEC Remote Gyro, Part number 6444  | <input type="checkbox"/> | 3.38            | 186.58              | 630.65          |
|          | ab.) S-TEC Slaving Panel, Part number 01171-P   | <input type="checkbox"/> | 0.10            | 60.94               | 6.09            |
|          | ac.) S-TEC Flux Sensor, Part number 6446  | <input type="checkbox"/> | 0.38            | 104.06              | 39.54           |
|          | ad.) S-TEC Hardware installation kit, Part number 90480-1   | <input type="checkbox"/> | 0.63            | 58.94               | 37.13           |
|          | ae.) Compass STS-180/ HSI installation, harnesses and hardware Piper drawing 104261-3   | <input type="checkbox"/> | 5.37            | 124.25              | 667.36          |
|          | af.) Installation hardware, Piper drawing 104581-002 or 104581-005  | <input type="checkbox"/> | 0.33            | 60.92               | 20.29           |
|          | Removed Standard Directional Gyro, Sigma -Tek, Part number IU 262-001-37, Piper PS 50126-5, Piper code number 548-435, Cert. Basis TSO C5c                                    |                          | -2.48           | 59.75               | -148.27         |
|          | Removed Standard Turn Coordinator, Piper PS50030-3-5, Piper code number 548-190   |                          | -1.04           | 59.70               | -62.33          |
|          | Delta System weight   |                          | 36.12           | 113.66              | 4506.48         |
| 93       | S-TEC System 55X Autopilot with Compass STS-180/HSI and Flight Director (ADI), Piper drawing 104581-003 or 104581-006, (Marketing Option 510 – requires Marketing Option 595) |                          |                 |                     |                 |
|          | a.) S-TEC System 55 Autopilot with Compass STS-180/HSI, Piper drawing 104581-002 or 104581-005 (delta)  | <input type="checkbox"/> | 36.12           | 113.66              | 4506.48         |
|          | b.) S-TEC 901415-11 Autopilot Cables  | <input type="checkbox"/> | -0.019          | 18.20               | -0.346          |
|          | c.) S-TEC Flight Director Annunciator, Part number 01188-1P   | <input type="checkbox"/> | 0.60            | 60.2                | 36.12           |
|          | d.) S-TEC Flight Director Placards and Trim kit   | <input type="checkbox"/> | 0.45            | 62.94               | 28.45           |
|          | e.) S-TEC Altitude Selector/Alerter, Part number 0188-1PX, Piper code number 652-165  | <input type="checkbox"/> | 0.54            | 61.20               | 32.99           |
|          | S-TEC System 55X Autopilot with HSI and Flight Director (ADI) total weight  |                          | 37.70           | 111.684             | 4603.69         |
| 95       | Altitude Selector/Alerter installation, Piper drawing 104581-5, (Marketing Option 515 – requires Marketing Option 594 –Autopilot)   |                          |                 |                     |                 |
|          | a.) S-TEC Altitude Selector/Alerter, Part number 01279-PX, Piper code number 652-163  | <input type="checkbox"/> | 0.90            | 61.20               | 55.08           |
|          | b.) S-TEC Altitude Selector/Alerter Cable and hardware  | <input type="checkbox"/> | 0.35            | 60.90               | 21.02           |
|          | c.) S-TEC Altitude Selector/Alerter Placards kit  | <input type="checkbox"/> | 0.002           | 62.94               | 0.13            |
|          | Altitude Selector/Alerter installation total weight   |                          | 1.25            | 61.12               | 76.23           |



THE NEW PIPER AIRCRAFT, INC

PA-28R-201, ARROW  
EQUIPMENT LIST  
S/N 2844116 and UP

| Item No.                                     | Item  | Mark if Option Installed | Weight (Pounds) | Arm (In.) Aft Datum | Moment (Lb.-In.) |
|--|---|--------------------------|-----------------|---------------------|------------------|
| (f) Autopilot optional equipment – continued |   |                          |                 |                     |                  |
| 97   | Pilot STEC Trim And Mike Switch Assembly 101117-15, (Part of Marketing option 594)  | <input type="checkbox"/> | 0.21            | 68.94               | 14.59            |
|  | Removed Standard Pilot Mike Switch Assembly, Piper drawing 101117-005   |                          | -0.093          | 68.938              | -6.399           |
|  | Delta Weight  |                          | 0.12            | 68.94               | 8.19             |
| 99   | Pilot STEC System 55 Autopilot Switch Assembly, Piper drawing 101117-016, (Part of Marketing option 594)  | <input type="checkbox"/> | 0.28            | 68.94               | 19.45            |
|  | Removed Standard Pilot Mike Switch Assembly, Piper drawing 101117-005   |                          | -0.093          | 68.938              | -6.399           |
|  | Delta Weight  |                          | 0.19            | 68.94               | 13.05            |
| (g) Optional Avionics Equipment              |   |                          |                 |                     |                  |
| 111  | Deluxe Avionics package-Dual GNS 430 with STEC ST-180 HSI, (Marketing Option 595 - requires Marketing Option 594 -Autopilot (include items 91 or 93)) |                          |                 |                     |                  |
|  | a.) Garmin Dual GNS 430 GPS/Nav/Com, Piper drawing 105327-002   |                          |                 |                     |                  |
|  | 1.) Garmin GNS430 (11-33 Vdc) #1 with mount, connectors and data card, Piper PS50040-40-4, Piper code number 601-229                                  | <input type="checkbox"/> | 6.56            | 58.14               | 381.18           |
|  | 2.) Garmin GNS430 (11-33 Vdc) #2 with mount, connectors and data card, Piper PS50040-40-4, Piper code number 601-229                                  | <input type="checkbox"/> | 6.56            | 58.14               | 381.18           |
|  | 3.) Garmin GI-106A Indicator #2, Piper code number 602-239  | <input type="checkbox"/> | 1.02            | 60.23               | 61.43            |
|  | 4.) Cables/Harnesses and Hardware, Piper drawing 105327-002   | <input type="checkbox"/> | 3.31            | 55.59               | 183.86           |
|  | b.) Garmin GTX-330 Transponder installation and Dual GPS, Piper drawing 105329-003  |                          |                 |                     |                  |
|  | 1.) Garmin GTX330 Transponder Unit, Part number 011-00455-00, PS50040-12-15 Piper code number 652-370   | <input type="checkbox"/> | 4.20            | 59.24               | 248.80           |
|  | 2.) Garmin Transponder Antenna, Part number 010-10160-00, Piper code number 683-724   | <input type="checkbox"/> | 0.21            | 55.11               | 11.57            |
|  | 3.) Harness, and hardware, Piper drawing 105329-003   | <input type="checkbox"/> | 1.29            | 53.19               | 68.59            |
|  | c.) Altitude Reporter installation, Piper drawing 101415-002  |                          |                 |                     |                  |
|  | 1.) Altitude Reporter, Ameri-King Corporation Model AK-350, Piper code number 602-290   | <input type="checkbox"/> | 0.57            | 51.04               | 29.04            |
|  | 2.) Altitude Reporter assembly and hardware, Piper drawing 101415-002   | <input type="checkbox"/> | 0.34            | 53.52               | 18.17            |
|  | d.) Garmin GMA -340 Audio Amp installation, Piper drawing 104263-004, Cert. Basis- TSO C35d, C50c   |                          |                 |                     |                  |
|  | 1.) Garmin GMA 340 Audio Selector Panel, , Piper PS 50040-15-25 Piper code number 601-210   |                          |                 |                     |                  |
|  | a.) Garmin Part number 011-00401-10 GMA Audio Panel Marker /Receiver  | <input type="checkbox"/> | 1.57            | 59.84               | 93.95            |
|  | b.) Garmin Part number 011-00403-00 Connector/Rack Kit  | <input type="checkbox"/> | 0.17            | 59.84               | 10.17            |
|  | 2.) Harnesses, Brackets and hardware, Piper drawing 104263-004  | <input type="checkbox"/> | 2.27            | 70.66               | 160.39           |
|  | e.) Antenna installations, Navigation, VHF Comms #1 and 2, Marker beacon and GPS #1 and 2, Piper drawing 104253-003                                   |                          |                 |                     |                  |
|  | 1. NAV receiving AV12-PPR Antenna, Piper code number 451-802  | <input type="checkbox"/> | 0.40            | 264.90              | 105.96           |
|  | a.) Nav Antenna Cable assembly and hardware, Piper drawing 104253-003   | <input type="checkbox"/> | 1.11            | 180.39              | 200.15           |
|  | 2.) Comant CI-1125 Antenna Coupler, Piper code number 556-753   | <input type="checkbox"/> | 0.19            | 54.94               | 10.47            |
|  | 3.) VHF Comm #1 Comant CI-121 Antenna, Piper PS50040-18-2, Piper code number 596-664  | <input type="checkbox"/> | 0.54            | 158.50              | 85.99            |
|  | 4.) VHF Comm Antenna #2 Comant CI-122, Piper code number 683-725  | <input type="checkbox"/> | 0.60            | 123.36              | 74.14            |

ISSUED: 02/27/04  
REVISED: 10/12/2004

240-0129  
5 of 17



THE NEW PIPER AIRCRAFT, INC

PA-28R-201, ARROW  
EQUIPMENT LIST  
S/N 2844116 and UP

| Item No. | Item  | Mark if Installed        | Weight (Pounds) | Arm (In.) Aft Datum | Moment (Lb-In.) |
|----------|---|--------------------------|-----------------|---------------------|-----------------|
|          | (g) Optional Avionics Equipment-continued   |                          |                 |                     |                 |
| 111      | Deluxe Avionics package-Dual GNS 430 with STEC ST-180 HSI, (Marketing Option 595 - requires Marketing Option 594 -Autopilot (include items 91 or 93))-continued |                          |                 |                     |                 |
|          | e.) Antenna installations, Navigation, VHF Comms #1 and 2, Marker beacon and GPS #1 and 2, Piper drawing 104253-003-continued                                   |                          |                 |                     |                 |
|          | a.) Comm #2 Antenna Cable assembly and hardware, Piper drawing 104253-003   | <input type="checkbox"/> | 0.80            | 84.18               | 71.98           |
|          | 5.) Marker Beacon Antenna installation, Piper drawing 104253-003  |                          |                 |                     |                 |
|          | a.) Marker Beacon Antenna Comant CI-102, Piper PS50040-15-10, Piper code number 597-893   | <input type="checkbox"/> | 0.45            | 217.17              | 98.60           |
|          | b.) Marker Beacon Cable and hardware, Piper drawing 104253-003  | <input type="checkbox"/> | 0.70            | 136.26              | 94.99           |
|          | 6.) GPS Antenna #1 installation, Piper drawing 104253-003   |                          |                 |                     |                 |
|          | a.) Garmin Antenna Kit, Part number 010-10040-01, Piper code number 683-721   |                          |                 |                     |                 |
|          | 1.) Garmin GA56 Antenna, Part number 011-00134-00, Piper code number 683-721  | <input type="checkbox"/> | 0.24            | 116.17              | 28.11           |
|          | b.) Coax Cable with hardware, Piper drawing 104253-003  | <input type="checkbox"/> | 0.62            | 94.35               | 58.68           |
|          | 7.) GPS Antenna #2 installation, Piper drawing 104253-003   |                          |                 |                     |                 |
|          | a.) Garmin Antenna Kit #2, Part number 010-10040-01, Piper code number 683-721  |                          |                 |                     |                 |
|          | 1.) Garmin Antenna #2, Part number 011-00134-00 GA56, Piper code number 683-721   | <input type="checkbox"/> | 0.24            | 116.17              | 28.11           |
|          | b.) Coax Cable #2 with hardware, Piper drawing 104253-003   | <input type="checkbox"/> | 0.64            | 94.20               | 60.47           |
|          | 8.) Installation hardware, Piper drawing 104253-003   | <input type="checkbox"/> | 0.02            | 58.66               | 1.04            |
|          | Removed Standard Avionics installation  |                          | -25.01          | 76.90               | -1923.52        |
|          | Deluxe Avionics System with Autopilot weight  |                          | 11.02           | 99.30               | 733.08          |
| 113      | Deluxe Avionics package-Dual GNS 430 with STEC ST-180 HSI, (Marketing Option 595 - Non Autopilot)   |                          |                 |                     |                 |
|          | a.) Garmin Dual GNS 430 GPS/Nav/Com, Piper drawing 105327-002   |                          |                 |                     |                 |
|          | 1.) Garmin GNS430 (11-33 Vdc) #1 with mount, connectors and data card, Piper PS50040-40-4, Piper code number 601-229  | <input type="checkbox"/> | 6.56            | 58.14               | 381.18          |
|          | 2.) Garmin GNS430 (11-33 Vdc) #2 with mount, connectors and data card, Piper PS50040-40-4, Piper code number 601-229  | <input type="checkbox"/> | 6.56            | 58.14               | 381.18          |
|          | 3.) Garmin GI-106A Indicator #2, Piper code number 602-239  | <input type="checkbox"/> | 1.02            | 60.23               | 61.43           |
|          | 4.) Cables/Harnesses and Hardware, Piper drawing 105327-002   | <input type="checkbox"/> | 3.31            | 55.59               | 183.86          |
|          | b.) Garmin GTX-330 Transponder installation and Dual GPS, Piper drawing 105329-003  |                          |                 |                     |                 |
|          | 1.) Garmin GTX330 Transponder Unit, Part number 011-00455-00, PS50040-12-15 Piper code number 652-370   | <input type="checkbox"/> | 4.20            | 59.24               | 248.80          |
|          | 2.) Garmin Transponder Antenna, Part number 010-10160-00, Piper code number 683-724   | <input type="checkbox"/> | 0.21            | 55.11               | 11.57           |
|          | 3.) Harness and hardware, Piper drawing 105329-003  | <input type="checkbox"/> | 1.29            | 53.19               | 68.59           |
|          | c.) Altitude Reporter installation, Piper drawing 101415-002  |                          |                 |                     |                 |
|          | 1.) Altitude Reporter, Ameri-King Corporation Model AK-350, Piper code number 602-290   | <input type="checkbox"/> | 0.57            | 51.04               | 29.04           |

ISSUED: 02/27/04  
REVISED: 10/12/2004

240-0129  
6 of 17



THE NEW PIPER AIRCRAFT, INC

PA-28R-201, ARROW  
EQUIPMENT LIST  
S/N 2844116 and UP

| Item No.                                  | Item   | Mark if Option Installed | Weight (Pounds) | Arm (In.) Aft Datum | Moment (Lb-In.) |
|---|--|--------------------------|-----------------|---------------------|-----------------|
| (g) Optional Avionics Equipment-continued |  |                          |                 |                     |                 |
| 113                                       | Deluxe Avionics package-Dual GNS 430 with STEC ST-180 HSI, (Marketing Option 595 - Non Autopilot)-continued                                  |                          |                 |                     |                 |
|   | c.) Altitude Reporter installation, Piper drawing 101415-002-continued   |                          |                 |                     |                 |
|   | 2.) Altitude Reporter assembly and hardware, Piper drawing 101415-002  | <input type="checkbox"/> | 0.34            | 53.52               | 18.17           |
|   | d.) Garmin GMA -340 Audio Amp Installation, Piper drawing 104263-004, Cert. Basis- TSO C35d, C50c  |                          |                 |                     |                 |
|   | 1.) Garmin GMA 340 Audio Selector Panel, Piper PS 50040-15-25, Piper code number 601-210   |                          |                 |                     |                 |
|   | a.) Garmin GMA Audio Panel Marker /Receiver, Part number 011-00401-10  | <input type="checkbox"/> | 1.57            | 59.84               | 93.95           |
|   | b.) Garmin Connector/Rack Kit, Part number 011-00403-00  | <input type="checkbox"/> | 0.17            | 59.84               | 10.17           |
|   | 2.) Harnesses, Brackets and hardware, Piper drawing 104263-004   | <input type="checkbox"/> | 2.27            | 70.66               | 160.39          |
|   | e.) Antenna installations, Navigation, VHF Comms #1 and 2, Marker beacon and GPS #1 and 2, Piper drawing 104253-003                          | <input type="checkbox"/> | 7.98            | 126.39              | 1008.27         |
|   | f.) Compass ST-180, Horizontal Situation Indicator installation, Piper drawing 104261-003  |                          |                 |                     |                 |
|   | 1.) S-TEC Horizontal Situation Indicator, Part number 6443-PA, Piper code number 652-164   | <input type="checkbox"/> | 2.71            | 57.19               | 154.98          |
|   | 2.) S-TEC Remote Gyro, Part number 6444-1, Piper code number 652-164   | <input type="checkbox"/> | 3.38            | 186.58              | 630.65          |
|   | 3.) S-TEC Slaving Panel, Part number 01171-P, Piper code number 652-164  | <input type="checkbox"/> | 0.10            | 60.94               | 6.09            |
|   | 4.) S-TEC Flux Sensor, Part number 6446, Piper code number 652-164   | <input type="checkbox"/> | 0.38            | 104.06              | 39.54           |
|   | 5.) S-TEC Hardware installation kit, Part number 90480-1, Piper code number 652-164  | <input type="checkbox"/> | 0.63            | 58.94               | 37.13           |
|   | 6.) Harnesses, Brackets and Hardware, Piper drawing 104253-003   | <input type="checkbox"/> | 5.37            | 124.32              | 666.98          |
|   | Removed Standard Directional Gyro, Sigma -Tek, Part number IU 262-001-37, Piper PS 50126-5, Piper code number 548-435, Cert. Basis - TSO C5c |                          | -2.48           | 59.75               | -148.27         |
|   | Removed Standard Avionics installation   |                          | -25.01          | 76.90               | -1923.52        |
|   | Deluxe Avionics System without Autopilot weight  |                          | 21.11           | 99.30               | 2120.18         |
| 115                                       | Deluxe Avionics package-Dual GNS 430 with Honeywell KCS -55A HSI, Piper drawing CA-28-44110, (Marketing Option 595 - Non Autopilot)          |                          |                 |                     |                 |
|   | a.) Garmin Dual GNS 430 GPS/Nav/Com, Piper drawing 105327-002  |                          |                 |                     |                 |
|   | 1.) Garmin GNS430 (11-33 Vdc) #1 with mount, connectors and data card, Piper PS50040-40-4, Piper code number 601-229                         | <input type="checkbox"/> | 6.56            | 58.14               | 381.18          |
|   | 2.) Garmin GNS430 (11-33 Vdc) #2 with mount, connectors and data card, Piper PS50040-40-4, Piper code number 601-229                         | <input type="checkbox"/> | 6.56            | 58.14               | 381.18          |
|   | 3.) Garmin GI-106A Indicator #2, Piper code number 602-239   | <input type="checkbox"/> | 1.02            | 60.23               | 61.43           |
|   | 4.) Cables/Harnesses and Hardware, Piper drawing 105327-002  | <input type="checkbox"/> | 3.31            | 55.59               | 183.86          |
|   | b.) Garmin GTX-330 Transponder installation and Dual GPS, Piper drawing 105329-003   |                          |                 |                     |                 |
|   | 1.) Garmin GTX330 Transponder Unit, Part number 011-00455-00, Piper PS50040-12-15, Piper code number 652-370                                 | <input type="checkbox"/> | 4.20            | 59.24               | 248.80          |
|   | 2.) Garmin Transponder Antenna , Part number 010-10160-00, Piper code number 683-724   | <input type="checkbox"/> | 0.21            | 55.11               | 11.57           |
|   | 3.) Harness, and hardware, Piper drawing 105329-003  | <input type="checkbox"/> | 1.29            | 53.19               | 68.59           |
|   | c.) Altitude Reporter installation, Piper drawing 101415-002   |                          |                 |                     |                 |





THE NEW PIPER AIRCRAFT, INC

PA-28R-201, ARROW  
EQUIPMENT LIST  
S/N 2844116 and UP

| Item No.                                  | Item   | Mark if Option Installed | Weight (Pounds) | Arm (In.) Aft Datum | Moment (Lb.-In.) |
|---|--|--------------------------|-----------------|---------------------|------------------|
| (g) Optional Avionics Equipment-continued |  |                          |                 |                     |                  |
| 115                                       | Deluxe Avionics package-Dual GNS 430 with Honeywell KCS -55A HSI, Piper drawing CA-28-44110, (Marketing Option 595 - Non Autopilot)-continued  |                          |                 |                     |                  |
|   | c.) Altitude Reporter installation, Piper drawing 101415-002-continued   |                          |                 |                     |                  |
|   | 1.) Altitude Reporter, Ameri-King Corporation Model AK-350, Piper code number 602-290  | <input type="checkbox"/> | 0.57            | 51.04               | 29.04            |
|   | 2.) Altitude Reporter assembly and hardware, Piper drawing 101415-002  | <input type="checkbox"/> | 0.34            | 53.52               | 18.17            |
|   | d.) Garmin GMA -340 Audio Amp installation, Piper drawing 104253-004, Cert. Basis- TSO C35d, C50c  |                          |                 |                     |                  |
|   | 1.) Garmin GMA 340 Audio Selector Panel, Piper PS 50040-15-25 Piper code number 601-210  |                          |                 |                     |                  |
|   | a.) Garmin GMA Audio Panel Marker /Receiver, Part number 011-00401-10  | <input type="checkbox"/> | 1.57            | 59.84               | 93.95            |
|   | b.) Garmin, Connector/Rack Kit, Part number 011-00403-00   | <input type="checkbox"/> | 0.17            | 59.84               | 10.17            |
|   | 2.) Harnesses, Brackets and hardware, Piper drawing 104263-004   | <input type="checkbox"/> | 2.27            | 70.66               | 160.39           |
|   | e.) Antenna installations, Navigation, VHF Comms #1 and 2, Marker beacon and GPS #1 and 2, Piper drawing 104253-003  | <input type="checkbox"/> | 7.98            | 126.39              | 1008.27          |
|   | f.) Compass KCS-55A, Horizontal Situation Indicator installation, Piper drawing CA28-2-206-2   |                          |                 |                     |                  |
|   | 1.) KI-525A Pictorial Navigation indicator (HSI) with installation hardware, Honeywell part numbers 066-03046-0007, 050-1344-00, Piper drawing 87455-003, Piper code numbers 599-559 and 652-336                                       | <input type="checkbox"/> | 3.57            | 59.24               | 199.88           |
|   | 2.) KMF -112 Magnetic flux detector and installation hardware, Honeywell part numbers 071-1052-00, 050-1361-0, Piper drawing 87455-003, Piper code numbers 596-787, 596-791  | <input type="checkbox"/> | 0.31            | 104.06              | 31.74            |
|   | 3.) K51B Slaving Accessory and installation hardware, Honeywell part numbers 071-1242-0006, 050-1928-00, Piper drawing 87455-003, Piper code numbers 599-682, 598-694  | <input type="checkbox"/> | 0.22            | 61.83               | 13.76            |
|   | 4.) KG-102A Directional Gyro, Honeywell part number 060-0015-00, Piper drawing 87455-003, Piper code number 599-790  | <input type="checkbox"/> | 4.25            | 186.58              | 792.98           |
|   | 5.) KG-102A Directional Gyro kit part number 050-1410-01, Vibration mount assembly, Mounting screw (2), Ground strap, Honeywell part numbers 071-4025-01, 089-5909-07, 155-2001-00, Piper drawing 87455-003, Piper code number 599-390 | <input type="checkbox"/> | 0.51            | 186.73              | 95.05            |
|   | 6.) KK 1018 installation kit part number 050-2020-02, Flux mounting brackets, Gyro leveling bracket, hardware, Piper drawing 87455-003, Piper code number 599-232  | <input type="checkbox"/> | 0.68            | 173.42              | 118.46           |
|   | 6.) Harnesses, Brackets and Hardware, Piper drawings CA-28-2-206 and 87455-003   | <input type="checkbox"/> | 4.27            | 118.22              | 504.34           |
|   | Removed Standard Directional Gyro, Sigma -Tek, Part number IU 262-001-37, Piper PS 50126-5, Piper code number 548-435, Cert. Basis - TSO C5c   |                          | -2.48           | 59.75               | -148.27          |
|   | Removed Standard Avionics installation   |                          | -25.01          | 76.90               | -1923.52         |
|   | Deluxe Avionics System without Autopilot weight  |                          | 22.15           | 99.30               | 2341.01          |
| 117                                       | Dual GNS 430 Com/Nav/GPS with Dual GI-106A indicators, (Marketing Option 550 - Non Autopilot)  |                          |                 |                     |                  |
|   | a.) Garmin Dual GNS 430 GPS/Nav/Com, Piper drawing 105325-003  |                          |                 |                     |                  |



THE NEW PIPER AIRCRAFT, INC

PA-28R-201, ARROW  
EQUIPMENT LIST  
S/N 2844116 and UP

| Item No.                                  | Item  | Mark if Option Installed | Weight (Pounds) | Arm (In.) Aft Datum | Moment (Lb-In.) |
|---|---|--------------------------|-----------------|---------------------|-----------------|
| (g) Optional Avionics Equipment-continued |   |                          |                 |                     |                 |
| 117                                       | Dual GNS 430 Com/Nav/GPS with Dual GI-106A indicators, (Marketing Option 550 - Non Autopilot)-continued                                     |                          |                 |                     |                 |
|   | a.) Garmin Dual GNS 430 GPS/Nav/Com, Piper drawing 105325-003-continued   |                          |                 |                     |                 |
|   | 1.) Garmin GNS430 (11-33 Vdc) #1 with mount, connectors and data card, Piper PS50040-40-4, Piper code number 601-229                        | <input type="checkbox"/> | 6.56            | 58.14               | 381.18          |
|   | 2.) Garmin GNS430 (11-33 Vdc) #2 with mount, connectors and data card, Piper PS50040-40-4, Piper code number 601-229                        | <input type="checkbox"/> | 6.56            | 58.14               | 381.18          |
|   | 3.) Garmin GI-106A Indicator #1, Piper code number 602-239  | <input type="checkbox"/> | 1.02            | 60.23               | 61.43           |
|   | 4.) Garmin GI-106A Indicator #2, Piper code number 602-239  | <input type="checkbox"/> | 1.02            | 60.23               | 61.43           |
|   | 5.) Cables/Harnesses and Hardware, Piper drawing 105325-003   | <input type="checkbox"/> | 3.32            | 55.62               | 184.59          |
|   | b.) Garmin GTX-330 Transponder installation and Dual GPS, Piper drawing 105329-003  |                          |                 |                     |                 |
|   | 1.) Garmin GTX330 Transponder, Unit Part number 011-00455-00, PS50040-12-15 Piper code number 552-370                                       | <input type="checkbox"/> | 4.20            | 59.24               | 248.80          |
|   | 2.) Garmin Transponder Antenna, Part number 010-10160-00, Piper code number 683-724   | <input type="checkbox"/> | 0.21            | 55.11               | 11.57           |
|   | 3.) Harness and hardware, Piper drawing 105329-003  | <input type="checkbox"/> | 1.29            | 53.19               | 68.59           |
|   | c.) Altitude Reporter installation, Piper drawing 101415-002  |                          |                 |                     |                 |
|   | 1.) Altitude Reporter, Ameri-King Corporation Model AK-350, Piper code number 602-290   | <input type="checkbox"/> | 0.57            | 51.04               | 29.04           |
|   | 2.) Altitude Reporter assembly and hardware, Piper drawing 101415-002   | <input type="checkbox"/> | 0.34            | 53.52               | 18.17           |
|   | d.) Garmin GMA 340 Audio Amp installation, Piper drawing 104263-004, Cert. Basis- TSO C35d, C50c  |                          |                 |                     |                 |
|   | 1.) Garmin GMA 340 Audio Selector Panel, Piper PS 50040-15-25 Piper code number 601-210   |                          |                 |                     |                 |
|   | a.) Garmin Part number 011-00401-10 GMA Audio Panel Marker /Receiver  | <input type="checkbox"/> | 1.57            | 59.84               | 93.95           |
|   | b.) Garmin Part number 011-00403-00 Connector/Rack Kit  | <input type="checkbox"/> | 0.17            | 59.84               | 10.17           |
|   | 2.) Harnesses, Brackets and hardware, Piper drawing 104263-004  | <input type="checkbox"/> | 2.27            | 70.66               | 160.39          |
|   | e.) Antenna installations, Navigation, VHF Comms #1 and 2, Marker beacon and GPS #1 and 2, Piper drawing 104253-003                         | <input type="checkbox"/> | 7.98            | 126.39              | 1008.27         |
|   | Removed Standard Avionics installation  |                          | -25.01          | 76.90               | -1923.52        |
|   | Dual GNS 430 Com/Nav/GPS with Dual GI-106 indicators system weight  |                          | 12.05           | 99.30               | 795.24          |
| 119                                       | S-TEC ADF RCR-650D installation, Piper drawing 104269-004, (Marketing Option 525 requires Marketing option 595, (Include items 111 or 113)) |                          |                 |                     |                 |
|   | a.) S-TEC ADF (RCR-650D), Piper PS 50040-31-32, Piper code number 652-167   |                          |                 |                     |                 |
|   | 1.) S-TEC Receiver RCR-650D, Part number 01283-01   | <input type="checkbox"/> | 2.48            | 58.04               | 144.17          |
|   | 2.) S-TEC Receiver installation kit, Part number 690212   | <input type="checkbox"/> | 0.55            | 61.24               | 33.68           |
|   | 3.) S-TEC Indicator IND-650D, Part number 690113-P  | <input type="checkbox"/> | 0.66            | 61.24               | 40.42           |
|   | 4.) S-TEC Indicator installation kit, Part number 690217  | <input type="checkbox"/> | 0.18            | 61.24               | 11.02           |
|   | 5.) S-TEC Antenna ANT-650D, Part number 690124  | <input type="checkbox"/> | 2.28            | 162.76              | 371.09          |
|   | 6.) S-TEC Antenna installation kit, Part number 690215  | <input type="checkbox"/> | 0.02            | 161.78              | 3.24            |
|   | b.) Harness, bracket and hardware, Piper drawing 105206-104   | <input type="checkbox"/> | 2.65            | 72.20               | 191.27          |
|   | S-TEC ADF RCR-650D installation total weight  |                          | 8.82            | 90.09               | 794.89          |



THE NEW PIPER AIRCRAFT, INC

PA-28R-201, ARROW  
EQUIPMENT LIST  
S/N 2844116 and UP

| Item No.                                  | Item  | Mark if Option Installed | Weight (Pounds) | Arm (In.) Aft Datum | Moment (Lb-In.) |
|---|---|--------------------------|-----------------|---------------------|-----------------|
| (g) Optional Avionics Equipment-continued |   |                          |                 |                     |                 |
| 121                                       | S-TEC DME 451 with /450 Indicator installation, Piper drawing 104257-003, (Marketing Option 575 requires Marketing option 595, (Include items 111 or 113))) |                          |                 |                     |                 |
|   | a.) S-TEC DME installation kit, Piper PS50040-31-26, Piper code number 601-212  |                          |                 |                     |                 |
|   | 1.) S-TEC Transceiver TCR-451, Part number 690109   | <input type="checkbox"/> | 4.80            | 200.70              | 963.36          |
|   | 2.) S-TEC Transceiver installation kit, Part number 690224  | <input type="checkbox"/> | 0.69            | 200.70              | 137.88          |
|   | 3.) S-TEC Indicator IND-450, Part number 690111-P   | <input type="checkbox"/> | 0.54            | 60.44               | 32.70           |
|   | 4.) S-TEC Indicator installation kit, Part number 690221  | <input type="checkbox"/> | 0.08            | 60.44               | 4.82            |
|   | 5.) S-TEC Antenna ANT-451, Part number 690126   | <input type="checkbox"/> | 0.19            | 123.74              | 23.88           |
|   | 6.) S-TEC Antenna installation kit, Part number 690218  | <input type="checkbox"/> | 0.05            | 123.74              | 5.88            |
|   | b.) Harness and hardware, Piper drawing 104257-003  | <input type="checkbox"/> | 3.53            | 90.75               | 320.22          |
|   | S-TEC DME 451 installation total weight   |                          | 9.88            | 150.73              | 1488.73         |
| 123                                       | S-TEC Manual Electric Trim installation, Piper drawing 100831-3, (Marketing Option 577)   |                          |                 |                     |                 |
|   | a. S-TEC Trim Servo 0105-8-T6, Piper code number 651-658  | <input type="checkbox"/> | 2.90            | 159.25              | 461.83          |
|   | b. S-TEC Monitor/Sonalert Trim Monitor, Part number 01240-2, Piper code number 651-976  | <input type="checkbox"/> | 0.30            | 57.50               | 17.25           |
|   | c. S-TEC Monitor/Sonalert, Sonalert, Part number 6551, Piper code number 651-976  | <input type="checkbox"/> | 0.10            | 58.18               | 5.82            |
|   | d. S-TEC Trim Servo installation kit-Hardware, Part number 90403-1, Piper code number 651-658   | <input type="checkbox"/> | 0.93            | 153.27              | 147.70          |
|   | e. S-TEC Trim Switch and Cable installation kit, Part number 90403-2, Piper code number 651-657   | <input type="checkbox"/> | 0.88            | 102.73              | 90.90           |
|   | f. S-TEC Monitor/Sonalert installation kit Hardware, Part number 90403-3, Piper code number 651-976   | <input type="checkbox"/> | 0.17            | 57.54               | 10.01           |
|   | g. Harnesses, Brackets and Hardware, Piper drawing 100831-3   | <input type="checkbox"/> | 0.60            | 78.97               | 47.59           |
|   | h. Pilot STEC Trim And Mike Switch Assembly, Piper drawing 101117-015   | <input type="checkbox"/> | 0.20            | 68.94               | 14.12           |
|   | Removed Pilot Mike Switch Assembly, Piper drawing 101117-005  |                          | -0.09           | 68.94               | -6.40           |
|   | S-TEC Manual Electric Trim installation weight  |                          | 6.01            | 131.32              | 788.81          |



THE NEW PIPER AIRCRAFT, INC

PA-28R-201, ARROW  
EQUIPMENT LIST  
S/N 2844116 and UP

| Item No.  | Item  | Mark if Installed                   | Weight (Pounds) | Arm (In.) Aft Datum | Moment (Lb-In.) |
|---|---|-------------------------------------|-----------------|---------------------|-----------------|
| (h) Avidyne Entegra Avionics (Optional Equipment) |   |                                     |                 |                     |                 |
| 141   | Standard Entegra Avionics Package, Piper drawings 101901-003, 101901-100, 101901-101, 101901-102, 101901-103, 101901-104, 101901-109, and 101901-111, and 101901-115 (Marketing option AVI) |                                     |                 |                     |                 |
|   | Garmin GNS 430 (11-33VDC)/GNS 430 (11-33VDC) System installation - Dual COM/NAV/GPS Piper drawings 101901-100 and 101901-101  |                                     |                 |                     |                 |
|   | a.) Garmin GNS 430 System installation - Dual COM/NAV/GPS, Piper drawing 101901-100, Cert. Basis TSO 37d,C38d, C40c, C36e, C34e, C129a  |                                     |                 |                     |                 |
|   | 1.) Garmin GNS430 (11-33VDC) #1 with mount, connectors and data card Piper PS50040-40-4, Piper drawing 101901-100 Piper code number 601-229   | <input checked="" type="checkbox"/> | 6.56            | 58.14               | 381.18          |
|   | 2.) Hardware Piper drawings 101901-100  | <input checked="" type="checkbox"/> | 0.07            | 62.95               | 4.17            |
|   | 3.) NAV receiving AV12-PPR Antenna Piper code number 451-802 Piper drawing 101901-100   | <input checked="" type="checkbox"/> | 0.40            | 264.90              | 105.96          |
|   | 4.) Nav Antenna Cable assembly and hardware Piper drawing 101901-100  | <input checked="" type="checkbox"/> | 1.55            | 148.42              | 229.57          |
|   | 5.) VHF Comm #1 Antenna Comant, Part number CI-122, Piper drawing 101901-100, Piper code number 683-725   | <input checked="" type="checkbox"/> | 0.60            | 123.74              | 74.37           |
|   | 6.) Comm #1 Antenna Cable assembly and hardware, Piper drawing, Piper drawing 101901-100  | <input checked="" type="checkbox"/> | 0.61            | 97.59               | 59.33           |
|   | 7.) GPS Antenna (Single) Piper drawing 101901-100   |                                     |                 |                     |                 |
|   | a.) Garmin GA56 Antenna #1, Part number 011-00134-00, Piper drawing 101901-100, Piper code number 683-721   | <input checked="" type="checkbox"/> | 0.24            | 101.12              | 24.47           |
|   | b.) Garmin Antenna Cable and hardware, Piper drawing 101901-100   | <input checked="" type="checkbox"/> | 0.61            | 85.21               | 52.07           |
|   | b.) Garmin GNS 430 System installation - Dual COM/NAV/GPS Piper drawing 101901-101, Cert. Basis TSO 37d,C38d, C40c, C36e, C34e, C129a   |                                     |                 |                     |                 |
|   | 1.) Garmin GNS430 (11-33VDC) #2 with mount, connectors and data card Piper PS50040-40-4 Piper code number 601-229   | <input checked="" type="checkbox"/> | 6.56            | 58.14               | 381.18          |
|   | 2.) Cable assemblies-Nav and Hardware, Piper drawing 101901--101  | <input checked="" type="checkbox"/> | 0.34            | 55.29               | 18.97           |
|   | 3.) #2 VHF Comm Comant Antenna, Part number CI-121, Piper drawing 101901-101, PS50040-18-2, Piper code number 596-664   | <input checked="" type="checkbox"/> | 0.54            | 158.40              | 85.93           |
|   | 4.) Comm #2 Antenna Cable assembly and hardware, Piper drawing 101901-101   | <input checked="" type="checkbox"/> | 0.86            | 113.40              | 97.24           |
|   | 5.) GPS Antenna (Single) Piper drawing 101901-101   | <input checked="" type="checkbox"/> |                 |                     |                 |
|   | a.) Garmin GA56 Antenna #2, Part number 011-00134-00 Piper drawing 101901-101, Piper code number 683-721  | <input checked="" type="checkbox"/> | 0.24            | 101.12              | 24.47           |
|   | b.) Garmin Antenna Cable and hardware, Piper drawing 101901-101   | <input checked="" type="checkbox"/> | 0.59            | 85.32               | 50.17           |
|   | c.) Garmin GTX-330 Transponder installation with AK--850 and Single GPS, Piper drawing 101901-109, Cert. Basis-TSO C74C   |                                     |                 |                     |                 |
|   | 1.) Garmin GTX330 Transponder, Part number 011-00455-00, Piper drawing 101901-109, PS50040-12-15, Piper code number 652-370   | <input checked="" type="checkbox"/> | 4.20            | 59.24               | 248.80          |
|   | 2.) Garmin Transponder Antenna, Part number 010-10160-00, Piper drawing 101901-109, Piper code number 683-724   | <input checked="" type="checkbox"/> | 0.21            | 55.11               | 11.57           |
|   | 3.) Backing plate, and hardware, Piper drawing 101901-109   | <input checked="" type="checkbox"/> | 0.26            | 57.10               | 15.02           |
|   | 4.) Altitude Reporter, Ameri-King Corporation Model AK-350, Piper drawing 101901-109, Piper code number 602-290   | <input checked="" type="checkbox"/> | 0.57            | 50.56               | 28.77           |
|   | 5.) Altitude Reporter assembly and hardware, Piper drawing 101901-109   | <input checked="" type="checkbox"/> | 0.34            | 51.71               | 17.44           |
|   | d.) Garmin GMA -340 Audio Amp installation Piper drawing 101901-102 Cert. Basis- TSO C35d, C50c   |                                     |                 |                     |                 |
|   | <i>Garmin GI-106P - Indicator</i>   | <input checked="" type="checkbox"/> | 1.02            | 60.23               | 61.43           |

AVIONTEC AG  
CH.145.0181

ISSUED: 02/27/04  
REVISED: 10/12/2004

240-0129  
11 of 17



THE NEW PIPER AIRCRAFT, INC

PA-28R-201, ARROW  
EQUIPMENT LIST  
S/N 2844116 and UP

| Item No.  | Item  | Mark if Option Installed            | Weight (Pounds) | Arm (In.) Aft Datum | Moment (Lb.-In.) |
|---|---|-------------------------------------|-----------------|---------------------|------------------|
| (h) Avidyne Entegra Avionics (Optional Equipment) |   |                                     |                 |                     |                  |
| 141   | Standard Entegra Avionics Package, Piper drawings 101901-003, 101901-100, 101901-101, 101901-102, 101901-103, 101901-104, 101901-109, and 101901-111, and 101901-115 (Marketing option AVI)-continued |                                     |                 |                     |                  |
|   | d.) Garmin GMA -340 Audio Amp installation Piper drawing 101901-102 Cert. Basis- TSO C35d, C50c-continued   |                                     |                 |                     |                  |
|   | 1.) Garmin GMA 340 Audio Selector Panel, Piper drawing 101901-102, Piper PS 50040-15-25 Piper code number 601-210   |                                     |                 |                     |                  |
|   | a.) Garmin GMA Audio Panel Marker /Receiver, Part number 011-00401-10   | <input checked="" type="checkbox"/> | 1.57            | 59.84               | 93.95            |
|   | b.) Garmin Connector/Rack Kit, Part number 011-00403-00   | <input checked="" type="checkbox"/> | 0.17            | 59.84               | 10.17            |
|   | 2.) Harnesses, Brackets and hardware, Piper drawing 101901-102  | <input checked="" type="checkbox"/> | 0.07            | 62.94               | 4.13             |
|   | 3.) Marker Beacon Antenna Comant, Part number CI-102, Piper drawing 101901-102, Piper PS50040-15-10, Piper code number 597-893  | <input checked="" type="checkbox"/> | 0.45            | 217.17              | 98.60            |
|   | 4.) Marker Beacon antenna cable and hardware Piper drawing 101901-102   | <input checked="" type="checkbox"/> | 0.72            | 106.06              | 76.10            |
|   | e.) Avidyne Entegra Primary Flight Display EXP-5000 installation, Piper drawing 101901-103  |                                     |                 |                     |                  |
|   | 1.) Avidyne Entegra Primary Flight Display EXP-5000, Avidyne part number 700-00006-002, Piper code number 652-523   | <input checked="" type="checkbox"/> | 12.40           | 59.03               | 732.01           |
|   | 2.) Avidyne Entegra Primary Flight Display EXP-5000 installation hardware, Piper drawing 101901-103   | <input checked="" type="checkbox"/> | 1.41            | 57.11               | 80.57            |
|   | 1.) Avidyne Entegra Multi Function Display EX-5000 installation, Piper drawing 101901-104   |                                     |                 |                     |                  |
|   | 1.) Avidyne Entegra Multi Function Unit, Avidyne part number ADY 700-00004-006, Piper code number 652-521   | <input checked="" type="checkbox"/> | 7.60            | 61.14               | 464.65           |
|   | 2.) Avidyne Entegra Multi Function Display EX-5000 installation hardware, Piper drawing 101901-104  | <input checked="" type="checkbox"/> | 0.05            | 62.94               | 3.31             |
|   | g.) Avidyne Entegra Magnetometer -Outside air temperature installation, Piper drawing 101901-111  |                                     |                 |                     |                  |
|   | 1.) Avidyne Entegra magnetometer, Avidyne Part number 700-00011-000, Piper code number 652-534  | <input checked="" type="checkbox"/> | 0.52            | 93.63               | 49.01            |
|   | 2.) Avidyne Entegra magnetometer, installation hardware and harness, Piper drawing 101901-111   | <input checked="" type="checkbox"/> | 1.14            | 101.98              | 116.02           |
|   | h.) Passenger interphone installation, Piper drawing 101901-115   | <input checked="" type="checkbox"/> | 0.42            | 114.88              | 48.21            |
|   | i.) Avidyne Entegra Data Acquisition Unit installation, Piper drawing 101903-002  |                                     |                 |                     |                  |
|   | 1.) Avidyne Entegra Data Acquisition Unit, Avidyne part number 200-00041-001, Piper code number 652-379   | <input checked="" type="checkbox"/> | 1.60            | 128.69              | 205.90           |
|   | 2.) Avidyne Entegra Data Acquisition Unit installation hardware, Piper drawing 101903-002   | <input checked="" type="checkbox"/> | 4.77            | 141.21              | 673.69           |
|   | j.) Avionics -System installation hardware, Piper drawing 101901-003  | <input checked="" type="checkbox"/> | 22.34           | 60.95               | 1361.94          |
|   | k.) Entegra structural installation   | <input checked="" type="checkbox"/> | 10.65           | 58.85               | 626.96           |
|   | l.) Electrical installation addition 101903-002   | <input checked="" type="checkbox"/> | 5.14            | 158.77              | 816.70           |
|   | m.) Standby Flight instruments installation, Piper drawings 38453-007   |                                     |                 |                     |                  |
|   | 1.) Truspeed Indicator, Piper PS50049-32T United Instruments Piper code number 548-167, Cert. Basis - TSO C2b   | <input checked="" type="checkbox"/> | 0.72            | 61.85               | 44.22            |
|   | 2.) Altimeter, Piper PS50008-10-2D -United UI5934PD-3A.134, Piper code number 599-549 Cert. Basis - TSO C10b  | <input checked="" type="checkbox"/> | 0.86            | 60.89               | 52.33            |

ISSUED: 02/27/04  
REVISED: 10/12/2004

240-0129  
12 of 17



THE NEW PIPER AIRCRAFT, INC

PA-28R-201, ARROW  
EQUIPMENT LIST  
S/N 2844116 and UP

| Item No.  | Item  | Mark if Option Installed            | Weight (Pounds) | Arm (In.) Aft Datum | Moment (Lb.-In.) |
|---|---|-------------------------------------|-----------------|---------------------|------------------|
| (h) Avidyne Entegra Avionics (Optional Equipment) |   |                                     |                 |                     |                  |
| 141   | Standard Entegra Avionics Package, Piper drawings 101901-003, 101901-100, 101901-101, 101901-102, 101901-103, 101901-104, 101901-109, and 101901-111, and 101901-115 (Marketing option AVI)-continued |                                     |                 |                     |                  |
|   | m.) Standby Flight instruments installation, Piper drawings 38453-007-continued   |                                     |                 |                     |                  |
|   | 3.) Standby attitude Indicator with battery pack option, Mid-Continent Part MD4300-411, Piper code number 602-319   | <input checked="" type="checkbox"/> | 3.67            | 58.64               | 215.20           |
|   | 4.) Standby flight instruments installation hardware Piper drawings 38453-007 and 35493-024   | <input checked="" type="checkbox"/> | 0.88            | 64.40               | 56.39            |
|   | Removed Standard Avionics Package, Piper drawings 105325-002, 105329-002, 101415-002, 104263-005, 104253-002, 101117-005, -006 and 104259-002   |                                     | -35.31          | 73.29               | -2588.15         |
|   | Removed standard structural installation  |                                     | -7.24           | 61.02               | -441.80          |
|   | Electrical installation removal 104304  |                                     | -4.62           | 88.72               | -409.97          |
|   | Removed Standard vacuum system installation, Piper drawing 85493-002  |                                     | -4.96           | 42.94               | -213.14          |
|   | Removed Auxiliary vacuum system installation, Piper drawing 89311-004   |                                     | -15.21          | 45.51               | -692.38          |
|   | Remove Flight instruments installation, Piper drawings 89620-002, 35493-015 and 79316-000   |                                     | -9.92           | 63.39               | -628.55          |
|   | Removed Engine instruments installation, Piper drawing 85343-004  |                                     | -3.72           | 59.62               | -221.90          |
|   | Delta Avidyne Entegra Standard System weight  |                                     | 21.51           | 118.33              | 2544.93          |
| 143   | S-TEC System 55X Autopilot installation-Avidyne Entegra System -only, Piper drawing 101904-002 (Marketing Option)   |                                     |                 |                     |                  |
|   | 1.) S-TEC Turn Coordinator, Part number 6405-28L  | <input checked="" type="checkbox"/> | 1.62            | 60.40               | 97.55            |
|   | 2.) Turn Coordinator hardware 101847-002  | <input checked="" type="checkbox"/> | 0.24            | 62.82               | 15.18            |
|   | 3.) S-TEC Programmer Computer, Part number 01192-1-48T  | <input checked="" type="checkbox"/> | 2.70            | 58.20               | 157.14           |
|   | 4.) S-TEC Mounting Tray, Part number 55254-1  | <input checked="" type="checkbox"/> | 0.35            | 58.20               | 20.49            |
|   | 5.) S-TEC Programmer Computer hardware  | <input checked="" type="checkbox"/> | 0.02            | 61.84               | 1.01             |
|   | 6.) S-TEC Transducer, Part number 0111  | <input checked="" type="checkbox"/> | 0.20            | 192.40              | 38.48            |
|   | 7.) S-TEC Transducer installation hardware  | <input checked="" type="checkbox"/> | 0.26            | 191.76              | 50.55            |
|   | 8.) S-TEC Roll Servo, Part number 0105-R9   | <input checked="" type="checkbox"/> | 2.77            | 118.74              | 329.38           |
|   | 9.) S-TEC Roll Servo bracket and hardware   | <input checked="" type="checkbox"/> | 0.66            | 119.76              | 78.68            |
|   | 10.) S-TEC Pitch Servo, Part number 0107-P4   | <input checked="" type="checkbox"/> | 2.82            | 232.73              | 655.60           |
|   | 11.) S-TEC Pitch Servo bracket and hardware   | <input checked="" type="checkbox"/> | 1.33            | 234.62              | 312.24           |
|   | 12.) S-TEC Trim Servo, Part number 0106-11-T6   | <input checked="" type="checkbox"/> | 2.90            | 160.73              | 466.12           |
|   | 13.) S-TEC Trim Servo brackets and hardware   | <input checked="" type="checkbox"/> | 1.40            | 159.53              | 223.12           |
|   | 14.) S-TEC Trim Monitor, Part number 01240  | <input checked="" type="checkbox"/> | 0.30            | 57.50               | 17.25            |
|   | 15.) S-TEC Sonalert, Part number 6551   | <input checked="" type="checkbox"/> | 0.10            | 57.50               | 5.75             |
|   | 16.) S-TEC Trim Monitor and Sonalert hardware   | <input checked="" type="checkbox"/> | 0.20            | 57.34               | 11.60            |
|   | 17.) Autopilot Servo Harness-Entegra - Piper drawing 101900   | <input checked="" type="checkbox"/> | 4.75            | 102.35              | 486.12           |
|   | 18.) S-TEC Flap Compensator-potentiometer installation  | <input checked="" type="checkbox"/> | 0.22            | 117.79              | 26.35            |
|   | 19.) S-TEC Switch installation (Control Wheel)  | <input checked="" type="checkbox"/> | 0.07            | 63.04               | 4.11             |
|   | 20.) Autopilot installation hardware Piper drawing 101847-002   | <input checked="" type="checkbox"/> | 0.41            | 61.23               | 25.27            |
|   | S-TEC System 55X Autopilot installation-Avidyne Entegra System weight   |                                     | 23.32           | 129.59              | 3021.99          |



THE NEW PIPER AIRCRAFT, INC

PA-28R-201, ARROW  
EQUIPMENT LIST  
S/N 2844116 and UP

| Item No.  | Item   | Mark if Option Installed            | Weight (Pounds) | Arm (In.) Aft Datum | Moment (Lb-In.) |
|---|--|-------------------------------------|-----------------|---------------------|-----------------|
| (h) Avidyne Entegra Avionics (Optional Equipment) |  |                                     |                 |                     |                 |
| 145   | Avidyne Entegra Multi Function Display EX-5000 installation with EMAX Engine indication system, Piper drawing 101901-104 (Marketing option 255)                                    |                                     |                 |                     |                 |
|   | 1.) Avidyne Entegra Multi Function Unit, Avidyne part number ADY 700-00004-006, Piper code number 652-521  | <input checked="" type="checkbox"/> | 7.60            | 61.14               | 464.65          |
|   | 2.) Avidyne Entegra Multi Function Display EX-5000 with EMAX Engine indication installation hardware, Piper drawing 101901-104 and 101902-118                                      | <input checked="" type="checkbox"/> | 1.25            | 51.57               | 64.59           |
|   | Remove Standard Multifunction display and hardware,-Piper drawing 101901-104   |                                     | -7.65           | 61.15               | -467.96         |
|   | Delta system weight  |                                     | 1.20            | 51.069              | 61.28           |
| 147   | Garmin GI-106A System installation, Piper drawing 101901-101, Avidyne Entegra system (only), (Marketing option 225)  |                                     |                 |                     |                 |
|   | a.) Garmin GI-106A Indicator, Piper PS 50040-40-2, Piper code number 602-230   | <input type="checkbox"/>            | 1.02            | 59.84               | 61.03           |
|   | b.) Cables/harnesses and hardware, Piper drawing 101901-101 and 101900-104   | <input type="checkbox"/>            | 0.54            | 58.01               | 31.13           |
|   | Garmin GI-106A System installation weight  |                                     | 1.56            | 59.21               | 92.21           |
| 149   | Avidyne Integrated Weather Data Link installation, Piper drawings 101901-107 and 101900-108, Avidyne Entegra system (only), (Marketing option 256)                                 |                                     |                 |                     |                 |
|   | a.) Avidyne Weather Data link antenna, Comant Part number CI-248-50, Piper code number 683-735   | <input type="checkbox"/>            | 0.51            | 158.40              | 80.63           |
|   | b.) Avidyne DC-50 Data link Antenna Coupler (14V), Part number ADY 850-00016-010, Piper code number 652-536  | <input type="checkbox"/>            | 0.63            | 49.10               | 31.06           |
|   | c.) Cables and hardware, Piper drawing 101901-107 and 101900-108   | <input type="checkbox"/>            | 0.67            | 76.46               | 51.38           |
|   | Removed Standard Comm Antenna # 2, Comant Industries Model CI-121, Piper drawing 101901-101, Piper code number 596-664   |                                     | -0.54           | 158.40              | -85.93          |
|   | Avidyne Integrated Weather Data Link installation weight   |                                     | 1.27            | 60.68               | 77.13           |
| 151   | S-TEC DME 451 with /450 Indicator installation, Avidyne Entegra System (only), Piper drawing 101901-105, (also include shelf installation item 159 or 161), (Marketing option 575) |                                     |                 |                     |                 |
|   | a.) S-TEC DME Installation Kit PS50040-31-26, Piper code number 601-212  |                                     |                 |                     |                 |
|   | 1.) S-TEC Transceiver TCR-451, Part number 690109  | <input checked="" type="checkbox"/> | 4.80            | 200.70              | 963.30          |
|   | 2.) S-TEC Transceiver installation Kit, Part number 690224   | <input checked="" type="checkbox"/> | 0.69            | 200.70              | 137.88          |
|   | 3.) S-TEC Indicator IND-450, Part number 690111-P  | <input checked="" type="checkbox"/> | 0.54            | 60.44               | 32.70           |
|   | 4.) S-TEC Indicator installation Kit, Part number 690221   | <input checked="" type="checkbox"/> | 0.08            | 60.44               | 4.82            |
|   | 5.) S-TEC Antenna ANT-451, Part number 690126  | <input checked="" type="checkbox"/> | 0.19            | 123.74              | 23.88           |
|   | 6.) S-TEC Antenna installation Kit, Part number 690218   | <input checked="" type="checkbox"/> | 0.05            | 123.74              | 5.88            |
|   | b.) Harness and hardware Piper drawing 101901-105  | <input checked="" type="checkbox"/> | 3.36            | 106.73              | 359.13          |
|   | S-TEC DME 451 with 450 Indicator installation Total Weight   |                                     | 9.71            | 157.28              | 1527.65         |



THE NEW PIPER AIRCRAFT, INC

PA-28R-201, ARROW  
EQUIPMENT LIST  
S/N 2844116 and UP

| Item No.  | Item  | Mark if Option Installed            | Weight (Pounds) | Arm (In.) Aft Datum | Moment (Lb.-In.) |
|---|---|-------------------------------------|-----------------|---------------------|------------------|
| (h) Avidyne Entegra Avionics (Optional Equipment) |   |                                     |                 |                     |                  |
| 153   | S-TEC ADF RCR 650D installation, Avidyne Entegra System (only), Piper drawing 101901-112 (Marketing option 525)   |                                     |                 |                     |                  |
|   | a.) S-TEC ADF Kit (RCR 650D), Piper PS50040-31-32, Piper code number 652-167  |                                     |                 |                     |                  |
|   | 1.) S-TEC Receiver RCR 650D, Part number 690108-4   | <input checked="" type="checkbox"/> | 2.484           | 58.038              | 144.17           |
|   | 2.) S-TEC Receiver installation Kit, Part number 690212   | <input checked="" type="checkbox"/> | 0.55            | 61.238              | 33.68            |
|   | 3.) S-TEC Indicator IND 650D, Part number 690113-P  | <input checked="" type="checkbox"/> | 0.66            | 61.238              | 40.42            |
|   | 4.) S-TEC Indicator installation Kit, Part number 690217  | <input checked="" type="checkbox"/> | 0.18            | 61.238              | 11.02            |
|   | 5.) S-TEC Antenna ANT 650D, Part number 690124  | <input checked="" type="checkbox"/> | 2.28            | 162.76              | 371.09           |
|   | 6.) S-TEC Antenna installation Kit, Part number 690215  | <input checked="" type="checkbox"/> | 0.02            | 161.78              | 3.24             |
|   | b.) Harness, Bracket and Hardware, Piper drawing 101901-112   | <input checked="" type="checkbox"/> | 2.64            | 72.04               | 190.47           |
|   | S-TEC ADF RCR 650D installation total weight  |                                     | 8.82            | 90.05               | 794.09           |
| 155   | WX500 Stormscope system installation, Piper drawing 101901-106 (also include shelf installation item 159), Avidyne Entegra System (only), (Marketing Option 330)                  |                                     |                 |                     |                  |
|   | 1.) wx-500 System (Stormscope), L3 Communications part number 830-11500-001, Piper drawing 72496-279, Piper code number 601-225   |                                     |                 |                     |                  |
|   | a.) WX-500 Stormscope processor, L3 Communications part number 805-11500-001, Piper code number 601-226   | <input type="checkbox"/>            | 1.70            | 202.00              | 343.40           |
|   | b.) WX-500 NY 163 Stormscope antenna, L3 Communications part number 805-10930-001, Piper code number 683-728  | <input type="checkbox"/>            | 0.81            | 206.00              | 165.83           |
|   | c.) WX-500 Stormscope antenna cable, L3 Communications part number 803-10950-004, Piper code number 653-688   | <input type="checkbox"/>            | 0.39            | 193.74              | 74.59            |
|   | d.) WX-500 Stormscope installation, L3 Communications part number 817-11500-001, Piper code number 601-227  | <input type="checkbox"/>            | 1.15            | 203.34              | 233.84           |
|   | 2.) Cable, Harness, Bracket and Hardware, Piper drawing 101901-106  | <input type="checkbox"/>            | 1.50            | 141.55              | 211.68           |
|   | WX500 Stormscope System installation total weight   |                                     | 5.54            | 185.96              | 1029.35          |
| 157   | TRC-497 Skywatch system installation, Piper drawing 101901-113, Avidyne Entegra System (only), (Marketing Option 332)   |                                     |                 |                     |                  |
|   | 1.) SKY -497 Systems (Skywatch), Piper drawing 72496-280  |                                     |                 |                     |                  |
|   | a.) TRC-497 Transmitter/Receiver Computer (Skywatch) L3 Communications part number 805-10800-001 with Mounting tray assembly part number 805-10870-001, Piper code number 601-223 | <input type="checkbox"/>            | 9.86            | 183.88              | 1813.09          |
|   | b.) TRC-497 Installation Kit, L3 Communications part number 817-10800-003, Piper code number 601-224  | <input type="checkbox"/>            | 0.51            | 183.88              | 93.78            |
|   | c.) TRC-497 NY164 Directional Antenna, L3 Communications part number 805-10890-001, Piper code number 683-726   | <input type="checkbox"/>            | 2.31            | 116.50              | 269.115          |
|   | d.) TRC-497 NY164 Directional Antenna installation Kit, L3 Communications part number 817-10009-006, Piper code number 683-727  | <input type="checkbox"/>            | 0.76            | 116.50              | 87.96            |
|   | 2.) Cable, Harness, Bracket and Hardware, Piper drawing 101901-113  | <input type="checkbox"/>            | 5.87            | 130.49              | 765.92           |
|   | TRC-497 Skywatch System installation total weight   |                                     | 19.30           | 156.95              | 3029.86          |
|   | <i>Flarm + Voice Module</i>   | <input checked="" type="checkbox"/> | <i>1.0</i>      | <i>57</i>           | <i>57</i>        |





THE NEW PIPER AIRCRAFT, INC

PA-28R-201, ARROW  
EQUIPMENT LIST  
S/N 2844116 and UP

| Item No.  | Item  | Mark if Option Installed            | Weight (Pounds) | Arm (In.) Aft Datum | Moment (Lb-In.)   |
|---|---|-------------------------------------|-----------------|---------------------|-------------------|
| (h) Avidyne Entegra Avionics (Optional Equipment) |   |                                     |                 |                     |                   |
| 159   | Shelf installation (Required with DME and WX-500 Stormscope installations, Avidyne Entegra System (only)), Piper drawing 101901-105, -106 and 99466-026 |                                     |                 |                     |                   |
|   | a.) Shelf assembly Piper drawing 101253-004   | <input type="checkbox"/>            | 1.07            | 201.60              | 215.03            |
| 161   | Shelf installation (Required with DME System without WX-500 Stormscope installation. Avidyne Entegra System (only)), Piper drawing 101901-105           |                                     |                 |                     |                   |
|   | a.) Shelf assembly Piper drawing 101253-002   | <input checked="" type="checkbox"/> | 0.69            | 201.60              | 138.43            |
| (i) Miscellaneous Optional Equipment              |   |                                     |                 |                     |                   |
| 181   | Air Conditioner installation (R-12), Piper drawing 99598-007, (Marketing Option 201)  |                                     |                 |                     |                   |
|   | a.) Condenser installation, Piper drawing 99855-000   | <input type="checkbox"/>            | 12.58           | 191.63              | 2403.8            |
|   | 1.) Condenser-Enviro Systems Part number 1250345, Piper code number 557-449   | <input type="checkbox"/>            | 4.28            | 179.94              | 770.1             |
|   | 2.) Condenser Frame Assembly, Piper drawing 99549-003   | <input type="checkbox"/>            | 3.39            | 180.63              | 612.5             |
|   | c.) Refrigerant lines installation, Piper drawing 99602-002   | <input type="checkbox"/>            | 8.25            | 88.73               | 732.80            |
|   | <del>d.) Electrical Installation, Piper drawing 99598-007</del>   | <del><input type="checkbox"/></del> | <del>3.34</del> | <del>172.12</del>   | <del>574.61</del> |
|   | e.) Compressor installation, Piper drawing 99109-000  | <input type="checkbox"/>            | 1.95            | 12.59               | 98.19             |
|   | 1.) Air conditioning compressor assembly-Compressor, Ultimate control inc. Part number EF21GR-25272 with Pitts Clutch Part number 10616                 | <input type="checkbox"/>            | 22.14           | 13.61               | 301.27            |
|   | f.) Bulkhead installation, Piper drawing 78734-004, (Evaporator installation items)   | <input type="checkbox"/>            | 3.34            | 172.12              | 574.61            |
|   | 1.) Evaporator- Outokumpu Heatercraft, Inc. part number HTC 35271204R, Piper drawing 99640-002, Piper code number 552-200                               | <input type="checkbox"/>            | 3.77            | 150.60              | 604.67            |
|   | 2.) Blower assembly, Piper drawing 99642-002  | <input type="checkbox"/>            | 3.90            | 174.72              | 681.42            |
|   | 3.) Receiver-Hydrator, Parker Aerospace Part number PAH 249099-10, Piper drawing 99640-002, Piper code number 456-615                                   | <input type="checkbox"/>            | 1.42            | 168.01              | 237.73            |
|   | Removed Standard Fresh Air Blower installation Piper drawing 36953-7 - Aft  |                                     | -8.79           | 187.61              | -1648.6           |
|   | Removed Cable Assembly/Duct assembly, Piper drawing 76493-002   |                                     | -1.79           | 167.19              | -300.00           |
|   | Air Conditioner installation weight   |                                     | 63.77           | 85.68               | 5463.57           |
| 183   | Crew Cup Holder (2), Piper drawing 89332-2  | <input type="checkbox"/>            | 0.1             | 61.8                | 6.2               |
| 185   | Lumbar Support installation Piper drawing 02585-2 and-3, (Marketing Options 410 and 412)  |                                     |                 |                     |                   |
|   | a. Pilot, Piper drawing 02585-2   | <input type="checkbox"/>            | 0.45            | 82.8                | 37.3              |
|   | b. Copilot, Piper drawing 02585-3   | <input type="checkbox"/>            | 0.45            | 83.0                | 37.4              |
| 187   | Locking Gas Cap installation, Piper drawing 39830-2, Piper drawing 66817-2  |                                     |                 |                     |                   |
|   | Locking Gas Caps (2), Piper drawing 39830-2   | <input type="checkbox"/>            | 0.74            | 93.849              | 69.45             |
|   | Standard Gas Caps (2), Piper drawing 66817-2  |                                     | -0.63           | 93.849              | -59.12            |
|   | Delta Weight  |                                     | 0.11            | 93.849              | 10.32             |



THE NEW PIPER AIRCRAFT, INC

PA-28R-201, ARROW  
EQUIPMENT LIST  
S/N 2844116 and UP

| Item No. | Item | Mark if Option Installed | Weight (Pounds) | Arm (In.) Aft Datum | Moment (Lb-In.) |
|----------|------|--------------------------|-----------------|---------------------|-----------------|
|----------|------|--------------------------|-----------------|---------------------|-----------------|

END FACTORY INSTALLED OPTIONS  
TOTAL OPTIONAL EQUIPMENT

65.5      124.3695      8146.2

END OF ORIGINAL EQUIPMENT INSTALLATION

05.06.03  
AVONITEC AG  
CH.145.018

x

Artex ELT System ME406

2.10      236.0      495.6

TABLE OF CONTENTS

SECTION 7

DESCRIPTION AND OPERATION  
OF THE AIRPLANE AND ITS SYSTEMS

| Paragraph<br>No. |   | Page<br>No. |
|------------------|---|-------------|
| 7.1              | The Airplane.....                               | 7-1         |
| 7.3              | Airframe .....                                  | 7-1         |
| 7.5              | Engine and Propeller .....                      | 7-2         |
| 7.7              | Induction System.....                           | 7-3         |
| 7.9              | Engine Controls.....                            | 7-4         |
| 7.11             | Landing Gear.....                               | 7-6         |
| 7.13             | Flight Controls.....                            | 7-10        |
| 7.15             | Fuel System.....                                | 7-11        |
| 7.17             | Electrical System.....                          | 7-14        |
| 7.19             | Vacuum System.....                              | 7-17        |
| 7.21             | Pitot-Static System .....                       | 7-18        |
| 7.23             | Instrument Panel.....                           | 7-20        |
| 7.25             | Cabin Features.....                             | 7-23        |
| 7.27             | Baggage Area .....                              | 7-24        |
| 7.29             | Heating, Ventilating and Defrosting System..... | 7-25        |
| 7.31             | Stall Warning.....                              | 7-27        |
| 7.33             | Finish.....                                     | 7-27        |
| 7.35             | Air Conditioning .....                          | 7-27        |
| 7.37             | Piper External Power.....                       | 7-29        |
| 7.39             | Emergency Locator Transmitter.....              | 7-29        |

**THIS PAGE INTENTIONALLY LEFT BLANK**

**SECTION 7  
DESCRIPTION AND OPERATION  
OF THE AIRPLANE AND ITS SYTEMS**

**7.1 THE AIRPLANE**

The PA-28R-201, Arrow is a single engine, retractable landing gear, all metal airplane. It has seating for up to four occupants, a 200 pound luggage compartment, and a 200 HP engine.

**7.3 AIRFRAME**

With the exception of the steel engine mount, the landing gear, miscellaneous steel parts, the cowling, and the lightweight plastic extremities (tips of wings, tail fin, rudder and stabilator), the basic airframe is of aluminum alloy. Aerobatics are prohibited in this airplane since the structure is not designed for aerobatic loads.

The fuselage is a semi-monocoque structure. There is a front door on the right side. A cargo door is installed aft of the rear seat.

The wing is of a conventional design semi-tapered and employs a laminar flow NACA 652-415 airfoil section. The main spar is located at approximately 40% of the chord aft of the leading edge. The wings are attached to the fuselage by the insertion of the butt ends of the spar into a spar box carry-through, which is an integral part of the fuselage structure. The bolting of the spar ends into the spar box carry-through structure, which is located under the aft seats, provides in effect a continuous main spar. The wings are also attached fore and aft of the main spar by an auxiliary front spar and a rear spar. The rear spar, in addition to taking torque and drag loads, provides a mount for flaps and ailerons. The four-position wing flaps are mechanically controlled by a handle located between the front seats. When fully retracted, the right flap locks into place to provide a step for cabin entry. Each wing contains one fuel tank.

### **7.3 AIRFRAME (continued)**

A vertical stabilizer, an all-movable horizontal stabilator, and a rudder make up the empennage. The stabilator incorporates an anti-servo tab which improves longitudinal stability and provides longitudinal trim. This tab moves in the same direction as the stabilator, but with increased travel.

### **7.5 ENGINE AND PROPELLER**

The Arrow incorporates a Lycoming IO-360-C1C6 four-cylinder, direct drive, horizontally opposed fuel injected engine rated at 200 horsepower at 2700 rpm. It is furnished with a starter, 60 ampere 14-volt alternator, shielded ignition, vacuum pump drive, fuel pump, propeller governor and a dry automotive type induction air filter. The recommended overhaul period is based on Lycoming service experience. Operation beyond the recommended time is the decision of the operator. Since Lycoming from time to time revises the recommended overhaul period, the owner should check the latest Lycoming Service Instruction No. 1009 at his Piper dealer for the latest recommended overhaul period and for any additional information.

The aircraft is equipped with a constant speed, controllable pitch propeller. The propeller control is located on the power quadrant between the throttle and mixture controls. A mixture control lock is provided to prevent activation of the mixture control instead of the pitch control.

The exhaust system is a crossover type, which reduces back pressure and improves performance. It is constructed entirely of stainless steel and is equipped with dual mufflers. Cabin heat and windshield defrosting are provided by a heater shroud around the muffler.

An oil cooler is located on the forward lower right side of the firewall, with the air inlet for the cooler located on the right side of the bottom cowling. A winterization plate is provided to restrict air during winter operation. (See Winterization in Handling and Servicing.)

**7.7 INDUCTION SYSTEM**

The induction system incorporates a Bendix RSA-5AD1 type fuel injector. The injector is based on the principle of differential pressure, which balances air pressure against fuel pressure. The regulated fuel pressure established by the servo valve when applied across a fuel control (jetting system) makes the fuel flow proportional to airflow. Fuel pressure regulation by the servo valve causes a minimal drop in fuel pressure throughout the metering system. Metering pressure is maintained above most vapor forming conditions while fuel inlet pressure is low enough to allow use of a diaphragm pump. The servo system feature also checks vapor lock and associated starting problems.

The servo regulation meters fuel flow proportionally with airflow and maintains the mixture as manually set for all engine speeds. The fuel flow divider receives metered fuel and distributes fuel to each cylinder fuel nozzle.

The fuel flow portion of the manifold pressure/fuel flow gauge is connected to the flow divider and monitors fuel pressure. This instrument converts fuel pressure to an indication of fuel flow in gallons per hour and percentage of rated horsepower.

The alternate air source of the induction system contains a door that functions automatically or manually. If the primary source is obstructed, the door will open automatically. It may be opened manually by moving the selector on the right side of the quadrant. The primary source should always be used for takeoff.

The pilot should read and follow the procedures recommended in the Lycoming Operator's Manual for this engine, in order to obtain maximum engine efficiency and time between engine overhauls.

## **7.9 ENGINE CONTROLS**

Engine controls consist of a throttle control, a propeller control and a mixture control lever. These controls are located on the control quadrant on the lower center of the instrument panel (Figure 7-1) where they are accessible to both the pilot and the copilot. The controls utilize teflon-lined control cables to reduce friction and binding.

The throttle lever is used to adjust the manifold pressure. It incorporates a gear up warning horn switch which is activated during the last portion of travel of the throttle lever to the low power position. If the landing gear is not locked down, the horn will sound until the gear is down and locked or until the power setting is increased. This is a safety feature to warn of an inadvertent gear up landing.

The propeller control lever is used to adjust the propeller speed from high rpm to low rpm.

The mixture control lever is used to adjust the air to fuel ratio. The engine is shut down by the placing of the mixture control lever in the full lean position. In addition, the mixture control has a lock to prevent activation of the mixture control instead of the pitch control. For information on the leaning procedure, see the Avco-Lycoming Operator's Manual.

The friction adjustment lever on the right side of the control quadrant may be adjusted to increase or decrease the friction holding the throttle, propeller, and mixture controls in a selected position.

The alternate air control is located to the right of the control quadrant. When the alternate air lever is in the up, or closed, position the engine is operating on filtered air; when the lever is in the down, or open, position the engine is operating on unfiltered, heated air (refer to Figure 7-1).



7.7 ENGINE CONTROLS (continued)

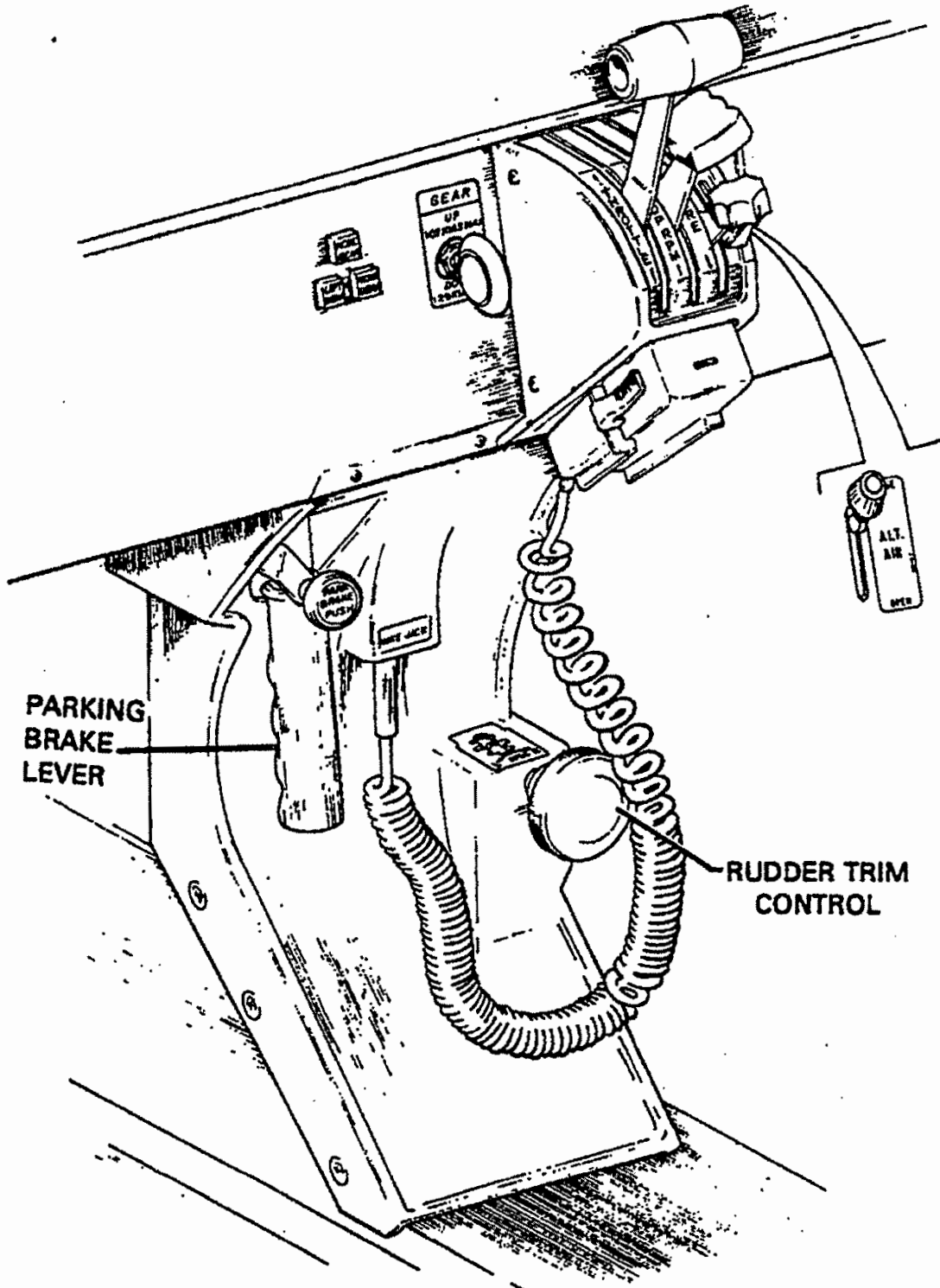

CONTROL QUADRANT AND CONSOLE

Figure 7-1

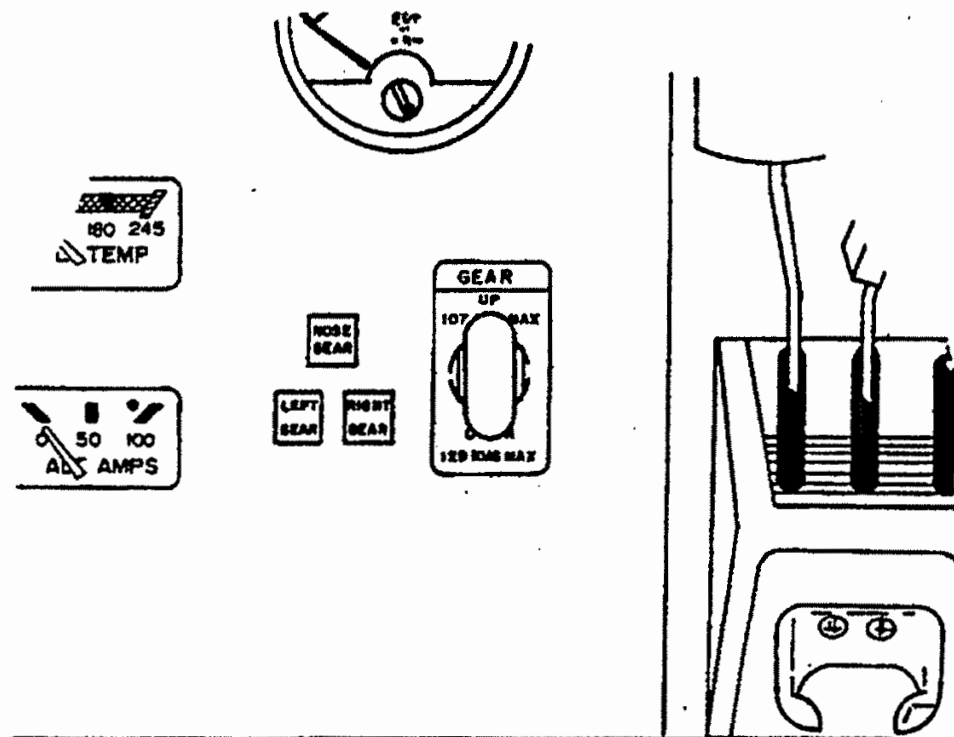

### LANDING GEAR SELECTOR

Figure 7-3

#### 7.11 LANDING GEAR

The Arrow is equipped with a retractable tricycle landing gear, which is hydraulically actuated by an electrically powered reversible pump. The pump is controlled by a selector switch on the instrument panel to the left of the control quadrant (Figure 7-3). The landing gear is retracted or extended in about seven seconds.

For emergency gear extension, the emergency gear lever, located between the front seats to the left of the flap handle (Figure 7-9), must be held in the down position to manually release hydraulic pressure and permit the gear to free fall. The nose gear is spring assisted.

Gear down and locked positions are indicated by three green lights located to the left of the selector. A red WARNING GEAR UNSAFE light, located at the top of the panel, illuminates while the gear is in transit, or not in the full up or locked down position. An all lights out condition indicates the gear is up. The landing gear should not be retracted above a speed of 107 KIAS and should not be extended above a speed of 129 KIAS.

**7.11 LANDING GEAR (continued)**

The main landing gear uses 6.00 x 6 wheels. The main gear incorporate brake drums and Cleveland single disc hydraulic brake assemblies. The nose wheel carries a 5.00 x 5 four ply tire and the main gear use 6.00 x 6 six ply tires. All three tires are tube type.

A microswitch in the throttle quadrant activates a warning horn and red **WARNING GEAR UNSAFE** light under the following conditions:

- a. Gear up and power reduced below approximately 14 inches of manifold pressure.
- b. Gear selector switch UP while on the ground and throttle in retarded position.
- c. Whenever the flaps are extended beyond the approach position (10°) and the landing gear are not down and locked.

The gear warning horn emits a 90 Hertz beeping sound in contrast to the stall warning horn which emits a continuous sound.

The nose gear is steerable through a 30 degree arc each side of center through the use of the rudder pedals. As the nose wheel retracts, the steering linkage disengages to reduce rudder pedal loads in flight. The nose wheel is equipped with a hydraulic shimmy damper to reduce nose wheel shimmy. A bungee assembly is also included to reduce ground steering effort and to dampen shocks and bumps during taxiing.

The oleo struts are of the air-oil type, with normal extension being 2.75 +/- 0.25 inches for the nose gear and 2.5 +/- 0.25 inches for the main gear under normal static load (empty weight of airplane plus full fuel and oil).

The standard brake system includes toe brakes on the left and right set of rudder pedals and a hand brake located below and near the center of the instrument panel. The toe brakes and the hand brake have individual brake cylinders, but all cylinders use a common reservoir. The parking brake is incorporated in the lever brake and is operated by pulling back on the lever (Figure 7-1) and depressing the knob attached to the top of the handle. To release the parking brake, pull back on the brake lever; then allow the handle to swing forward.

7.11 LANDING GEAR (continued)

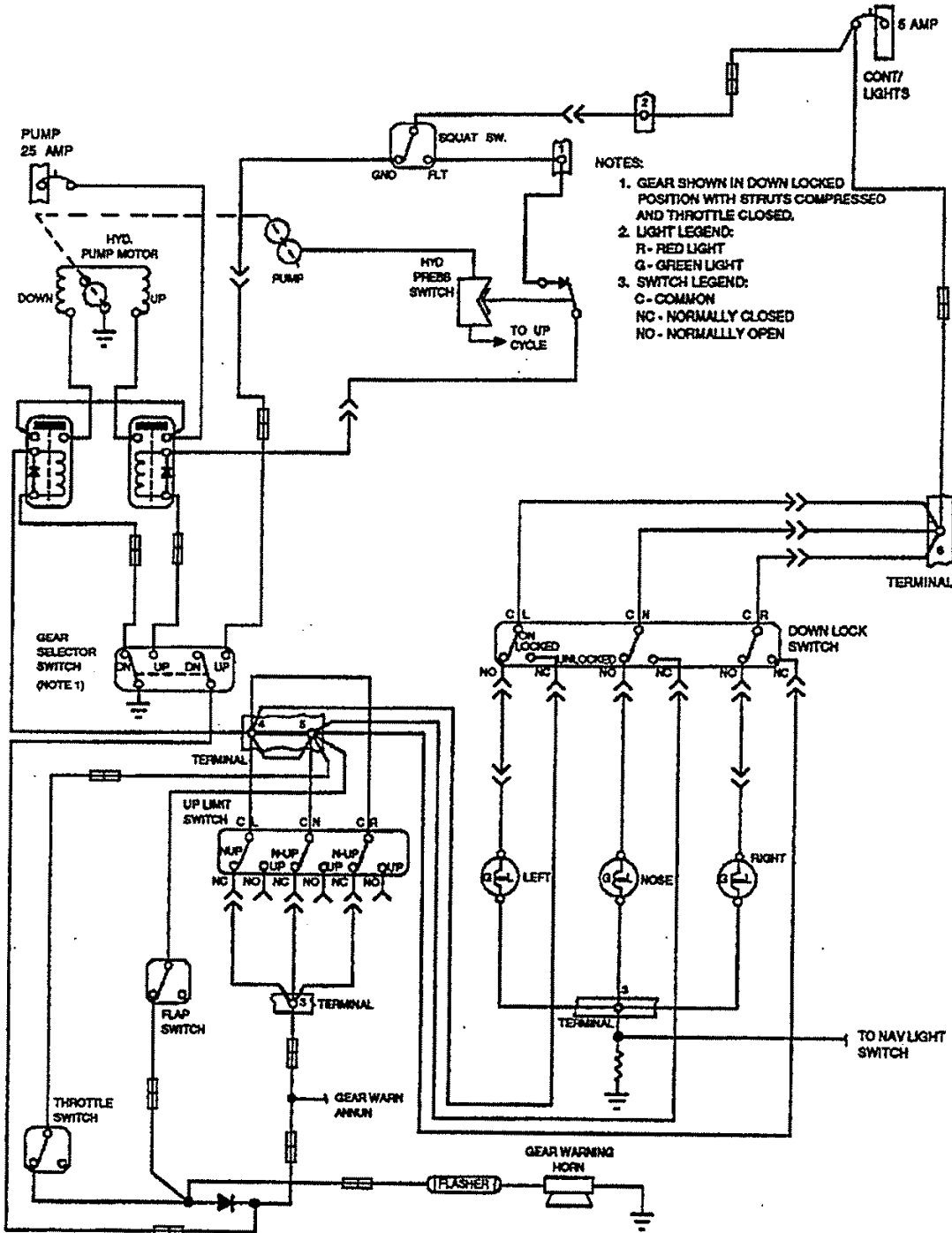

LANDING GEAR ELECTRICAL SCHEMATIC

Figure 7-5

7.11 LANDING GEAR (continued)

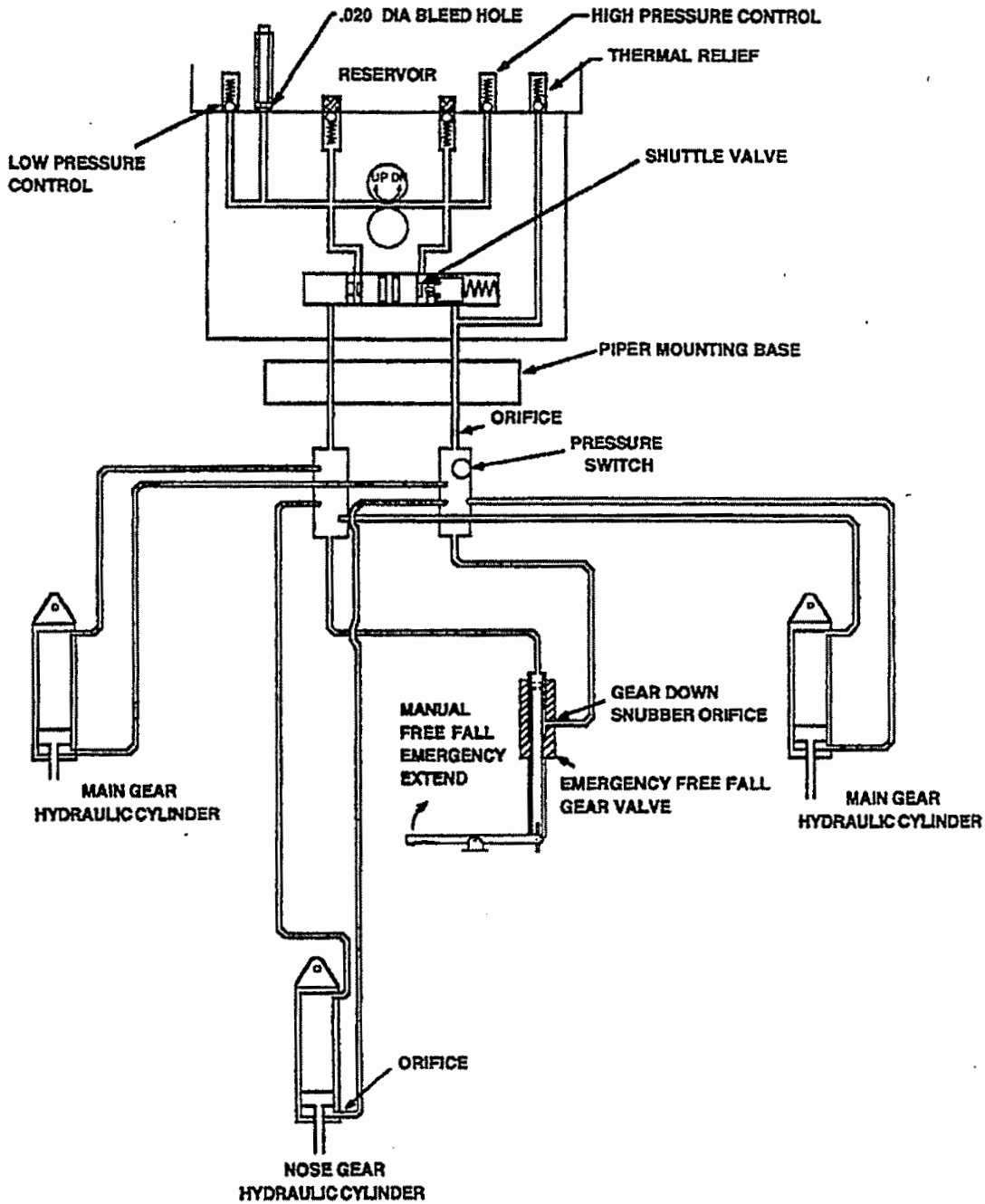

LANDING GEAR HYDRAULIC SCHEMATIC

Figure 7-7

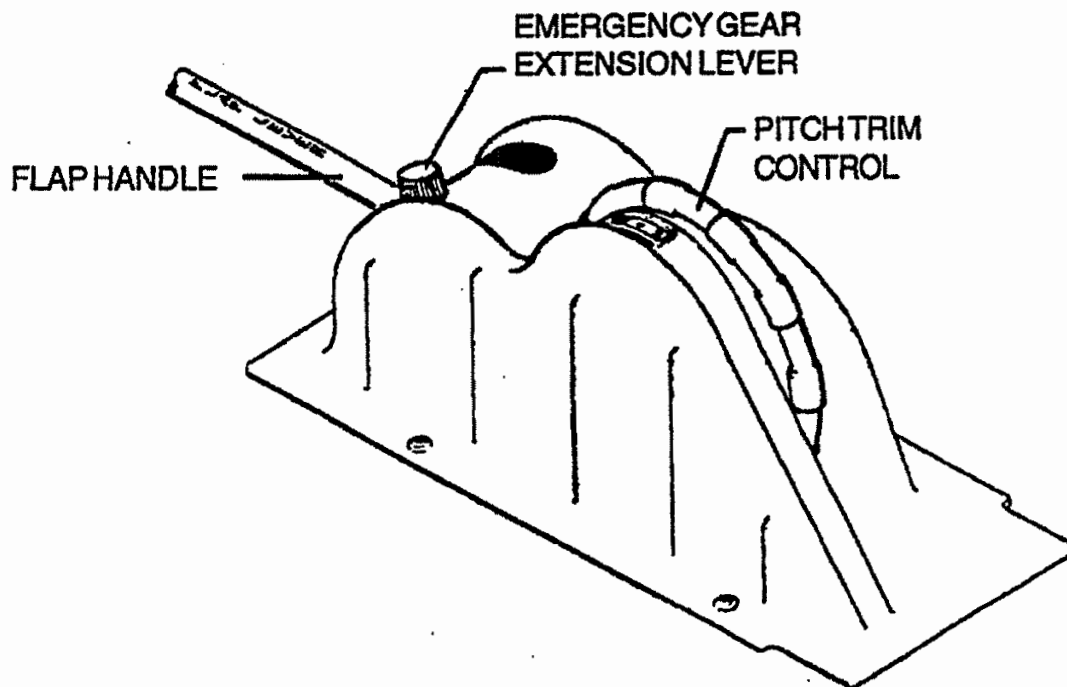

**FLIGHT CONTROL CONSOLE**

Figure 7-9

**7.13 FLIGHT CONTROLS**

Dual flight controls are provided as standard equipment. A cable system provides actuation of the control surfaces when the flight controls are moved in their respective directions.

The horizontal surface (stabilator) features a trim tab/servo mounted on the trailing edge. This tab serves the dual function of providing trim control and pitch control forces. The trim function is controlled by a trim control wheel located on the control console between the two front seats (Figure 7-9). Rotating the wheel forward gives nose down trim and rotation aft gives nose up trim.

The rudder is conventional in design and incorporates a rudder trim. The trim mechanism is a spring-loaded recentering device. The trim control is located on the right side of the pedestal below the throttle quadrant (Figure 7-1). Turning the trim control clockwise results in nose right trim and counterclockwise rotation results in nose left trim.

### 7.13 FLIGHT CONTROLS (continued)

Manually controlled flaps are provided. They are extended by a control cable and are spring-loaded to the retracted (up) position. The control is located between the two front seats on the control console (Figure 7-9). To extend the flaps pull the handle up to the desired flap setting of 10, 25, or 40 degrees. To retract, depress the button on the end of the handle and lower the control.

The airplane will experience a pitch change during flap extension or retraction. This pitch change can be corrected by either stabilator trim or increased control wheel force. When the flaps are in the retracted position the right flap, provided with a over-center lock mechanism, acts as a step.

#### NOTE

The right flap will support a load only in the fully retracted (up) position. When loading and unloading passengers make sure the flaps are in the retracted (up) position.

### 7.15 FUEL SYSTEM

The fuel system was designed with simplicity in mind. Fuel is contained in two 38.5 U.S. gallon tanks, one in each wing. Of the total 77 gallon capacity, only 72 gallons are usable. Each tank is equipped with a filler neck indicator tab to aid in determining fuel remaining when the tanks are not full. Usable capacity tab to the bottom of the indicator tab is 25 gallons. The minimum fuel grade is 100 octane (green) or 100LL (blue). The tanks are attached to the leading edge of the wing with screws and are an integral part of the wing structure. This allows removal for service. The tanks are vented individually by a vent tube which protrudes below the bottom of the wing at the rear inboard corner of each tank. The vents should be checked periodically to ensure they are not obstructed and will allow free passage of air.

Each fuel tank has an individual quick drain located at the bottom inboard rear corner. The fuel strainer also incorporates a quick drain, located on the left lower portion of the firewall. The quick drain protrudes thru the cowling to allow easy draining of the fuel strainer. To avoid the accumulation of water and sediment, and to check that the tanks contain the proper grade fuel, the fuel tank sumps and strainer should be drained daily prior to first flight and after refueling.

7.15 FUEL SYSTEM (continued)

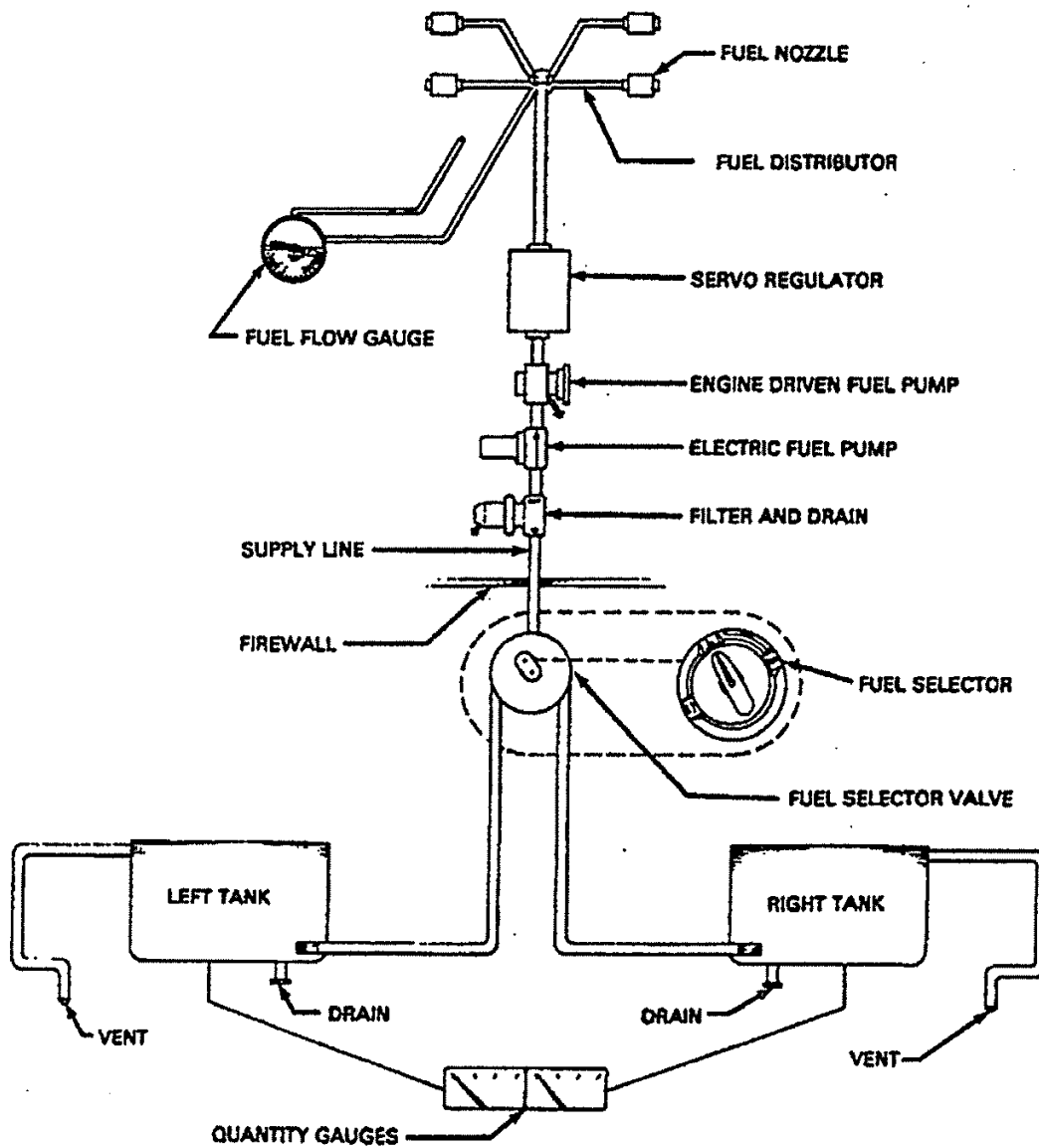

FUEL SYSTEM SCHEMATIC

Figure 7-11



## 7.15 FUEL SYSTEM (continued)

**FUEL SELECTOR**

Figure 7-13

**CAUTION**

When draining fuel, care should be taken to ensure that no fire hazard exists before starting the engine.

A fuel tank selector allows the pilot to control the flow of fuel to the engine, and is located on the left side wall below the instrument panel. It has three positions: OFF, LEFT TANK and RIGHT TANK. The arrow on the handle of the selector points to the tank which is supplying fuel to the engine. The valve also incorporates a safety latch which prevents inadvertently selecting the OFF position.

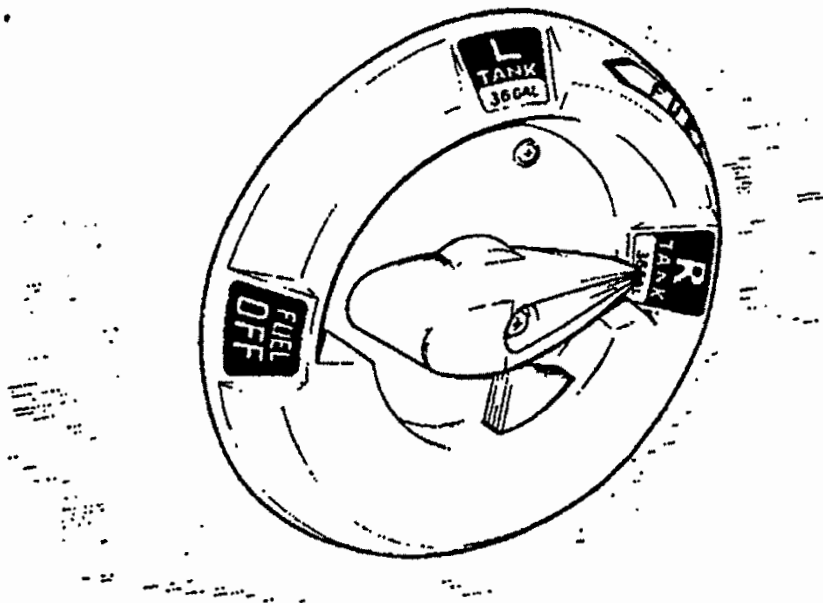
Normally fuel is supplied to the engine through an engine-driven fuel pump. An electric fuel pump serves as a back-up feature. The electric fuel pump is controlled by a rocker switch on the switch panel above the engine control quadrant. The electric fuel pump should be ON when switching fuel tanks and during takeoffs and landings.

Fuel quantity and flow/pressure are indicated on gauges on the instrument panel. There is a separate fuel quantity gauge for each tank.

### **7.17 ELECTRICAL SYSTEM**

All switches are grouped in a switch panel above the power quadrant. The circuit breaker panel is located on the lower right side of the instrument panel. Each breaker is clearly marked to show which circuit it protects. Also, circuit provisions are made to handle the addition of communications and navigational equipment.

Standard electrical accessories include alternator, starter, electric fuel pump, stall warning horn, ammeter, and annunciator panel.

The annunciator panel includes alternator, low oil pressure, and low vacuum indicator lights. The annunciator panel lights are provided only as a warning to the pilot that a system may not be operating properly, and that he should check and monitor the applicable system gauge to determine when or if action is required.

Optional electrical accessories include navigation, ground recognition, anti-collision, landing, instrument panel, and cabin dome lights. The navigation lights are controlled by a rocker switch on the main switch panel. Radio, panel, and switch lights are controlled by rheostat switches located below and to the right of the pilot's control wheel adjacent to the engine instruments.

An optional light, mounted in the overhead panel, provides instrument and cockpit lighting for night flying. The light is controlled by a rheostat switch located adjacent to the light. A map light window in the lens is actuated by an adjacent switch.

The optional wing tip recognition light consists of two lights, one in each wing tip, and is operated by a rocker type switch in the main switch panel.

#### **WARNING**

The navigation lights (NAV LIGHT) switch must be off to obtain full intensity gear lights during daytime flying. When the airplane is operated at night and the NAV LIGHT switch is turned on, the gear lights will automatically dim.

The anti-collision and landing lights are controlled by rocker switches on the main switch panel.

7.17 ELECTRICAL SYSTEM (continued)

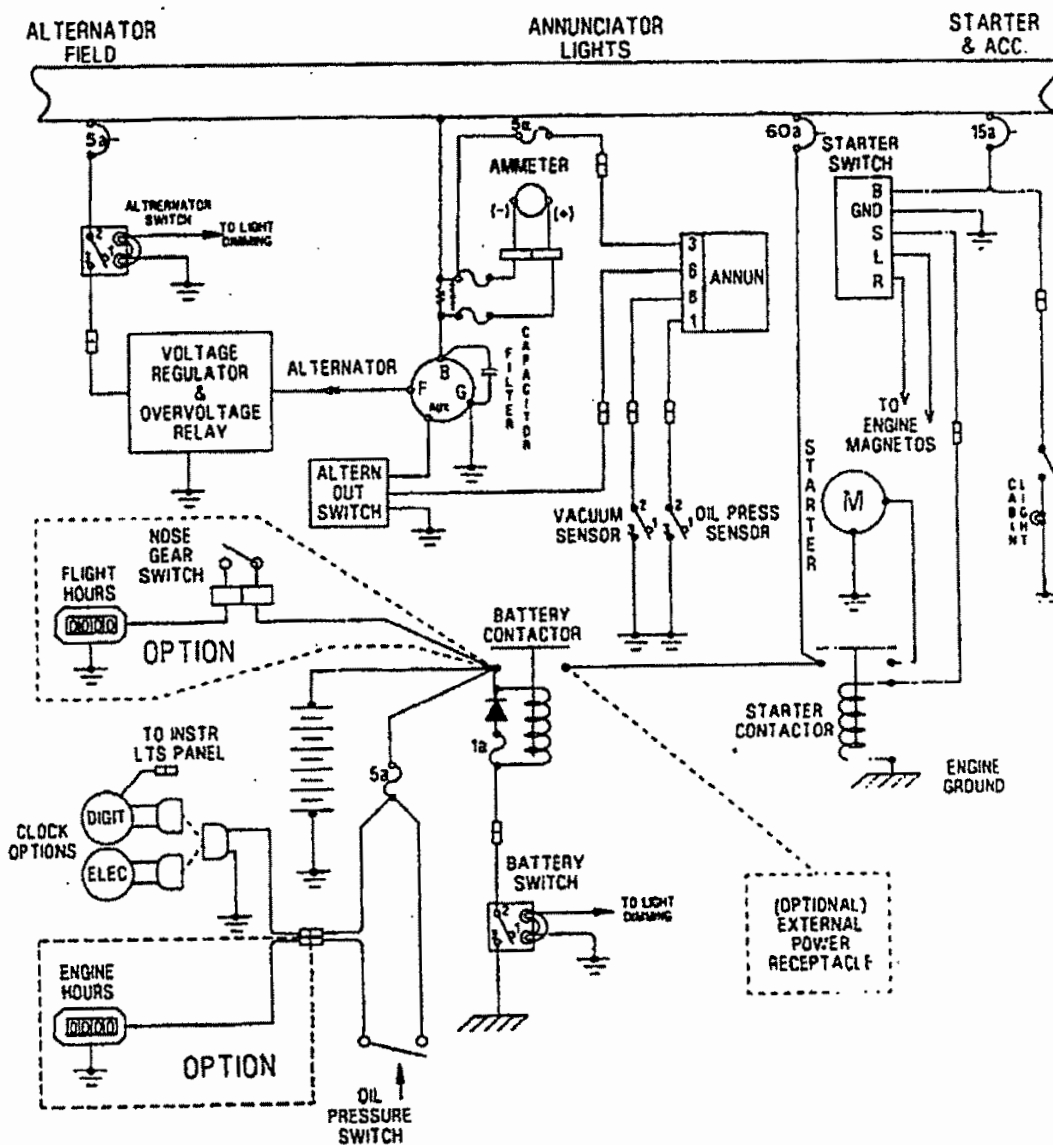

ALTERNATOR AND STARTER SCHEMATIC  
Figure 7-15

7.17 ELECTRICAL SYSTEM (continued)

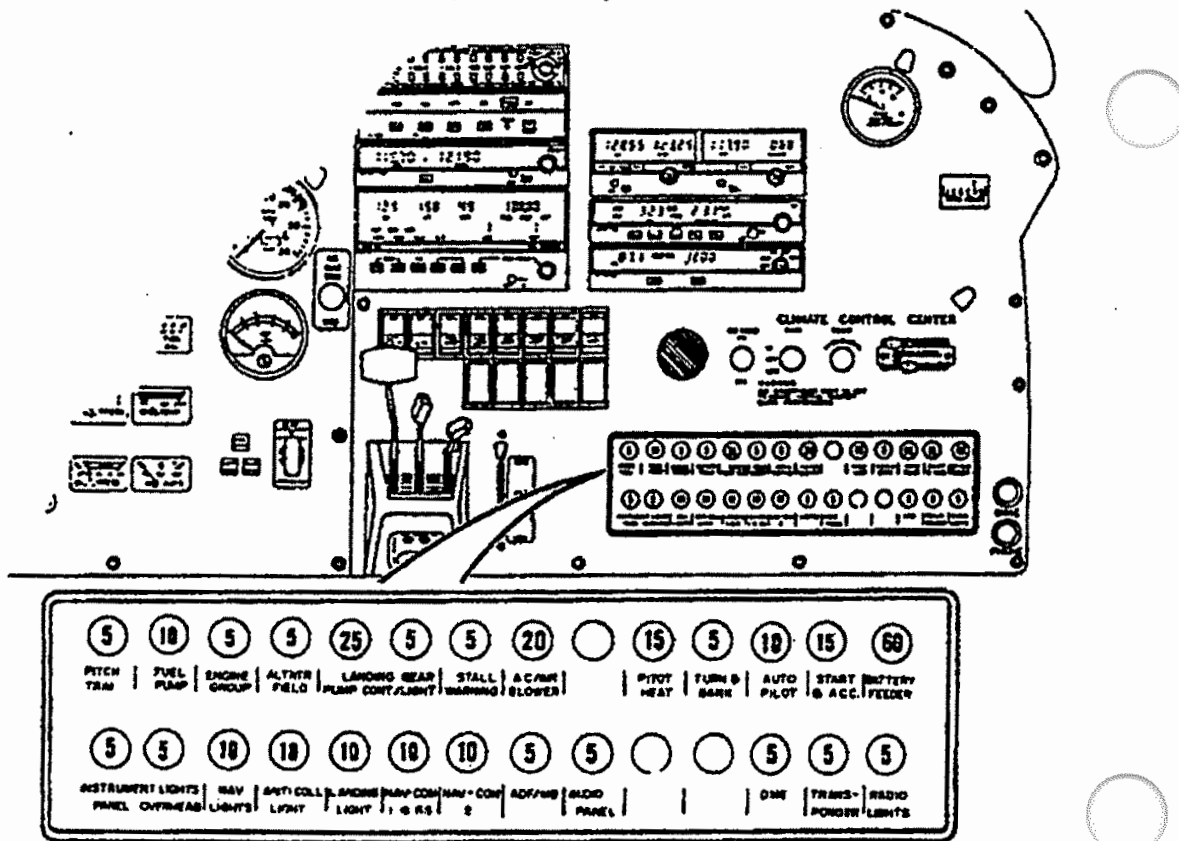

CIRCUIT BREAKER PANEL

Figure 7-17

**WARNING**

Strobe lights should not be operating when flying through overcast and clouds since reflected light can produce spacial disorientation. Do not operate strobe lights in close proximity to ground, during takeoff and landing.

The primary electrical power source is a 14-volt, 60-amp alternator, that is protected by an alternator control unit that incorporates a voltage regulator and a overvoltage relay. The alternator provides full electrical power output even at low engine rpm. This provides improved radio and electrical equipment operation and increases battery life by reducing battery load.

### 7.17 ELECTRICAL SYSTEM (continued)

Secondary power is provided by a 12-volt, 35-ampere-hour battery.

The ammeter as installed does not show battery discharge; rather it shows the electrical load placed on the system. With all the electrical equipment off, and the battery master (BATT MASTR) and alternator (ALTR) switches on, the ammeter will indicate the charging rate of the battery. As each electrical unit is switched on, the ammeter will indicate the total ampere draw of all the units including the battery. For example, the average continuous load for night flying with radios on is about 30 amperes. The 30 ampere value plus 2 amperes for charging the battery will then show on the ammeter, indicating the alternator is functioning properly.

Solenoids, provided in the battery and starter circuits, are used to control high current drain functions remotely from the cabin.

### 7.19 VACUUM SYSTEM

The vacuum system is designed to operate the air driven gyro instruments. This includes the directional and attitude gyros when installed. The system consists of an engine vacuum pump, a vacuum regulator, a filter and the necessary plumbing.

The vacuum pump is a dry type pump which eliminates the need for an air/oil separator and its plumbing. A shear drive protects the engine from damage. If the drive shears the gyros will become inoperative.

The vacuum gauge, mounted on the right instrument panel, (refer to Figure 7-21) provides valuable information to the pilot about the operation of the vacuum system. A decrease in pressure in a system that has remained constant over an extended period, may indicate a dirty filter, dirty screens, possibly a sticking vacuum regulator or leak in system (a low vacuum indicator light is provided in the annunciator panel). Zero pressure would indicate a sheared pump drive, defective pump, possibly a defective gauge or collapsed line. In the event of any gauge variation from the norm, the pilot should have a mechanic check the system to prevent possible damage to the system components or eventual failure of the system.

### **7.19 VACUUM SYSTEM (continued)**

A vacuum regulator is provided in the system to protect the gyros. The valve is set so the normal vacuum reads 4.8 to 5.1 inches of mercury, a setting which provides sufficient vacuum to operate all the gyros at their rated rpm. Higher settings will damage the gyros and with a low setting the gyros will be unreliable. The regulator is located behind the instrument panel.

If equipped with the optional auxiliary vacuum system, refer to Section 9, Supplement 3, for operation procedures.

### **7.21 PITOT-STATIC SYSTEM**

The system supplies both pitot and static pressure for the airspeed indicator, altimeter and vertical speed indicator (when installed).

Pitot pressure is picked up by the pitot head on the bottom of the left wing. An optional heated pitot head, which alleviates problems with icing or heavy rain, is available. The switch for pitot heat is located on the switch panel. Static pressure is sensed by button type vents on each side of the aft fuselage. Push-button type pitot and static drains are located on the lower left sidewall of the cockpit.

An alternate static source is available as optional equipment. The control valve is located below the left side of the instrument panel. When the valve is set in the alternate position, the altimeter, vertical speed indicator and airspeed indicator will be using cabin air for static pressure. The storm window and cabin vents must be closed and the cabin heater and defroster must be on during alternate static source operation. The altimeter error is less than 50 feet unless otherwise placarded.

To prevent bugs and water from entering the pitot pressure hole when the airplane is parked, a cover should be placed over the pitot head. A partially or completely blocked pitot head will give erratic or zero readings on the instruments.

#### **NOTE**

During preflight, check to make sure the pitot cover is removed.

7.21 PITOT-STATIC SYSTEM (continued)

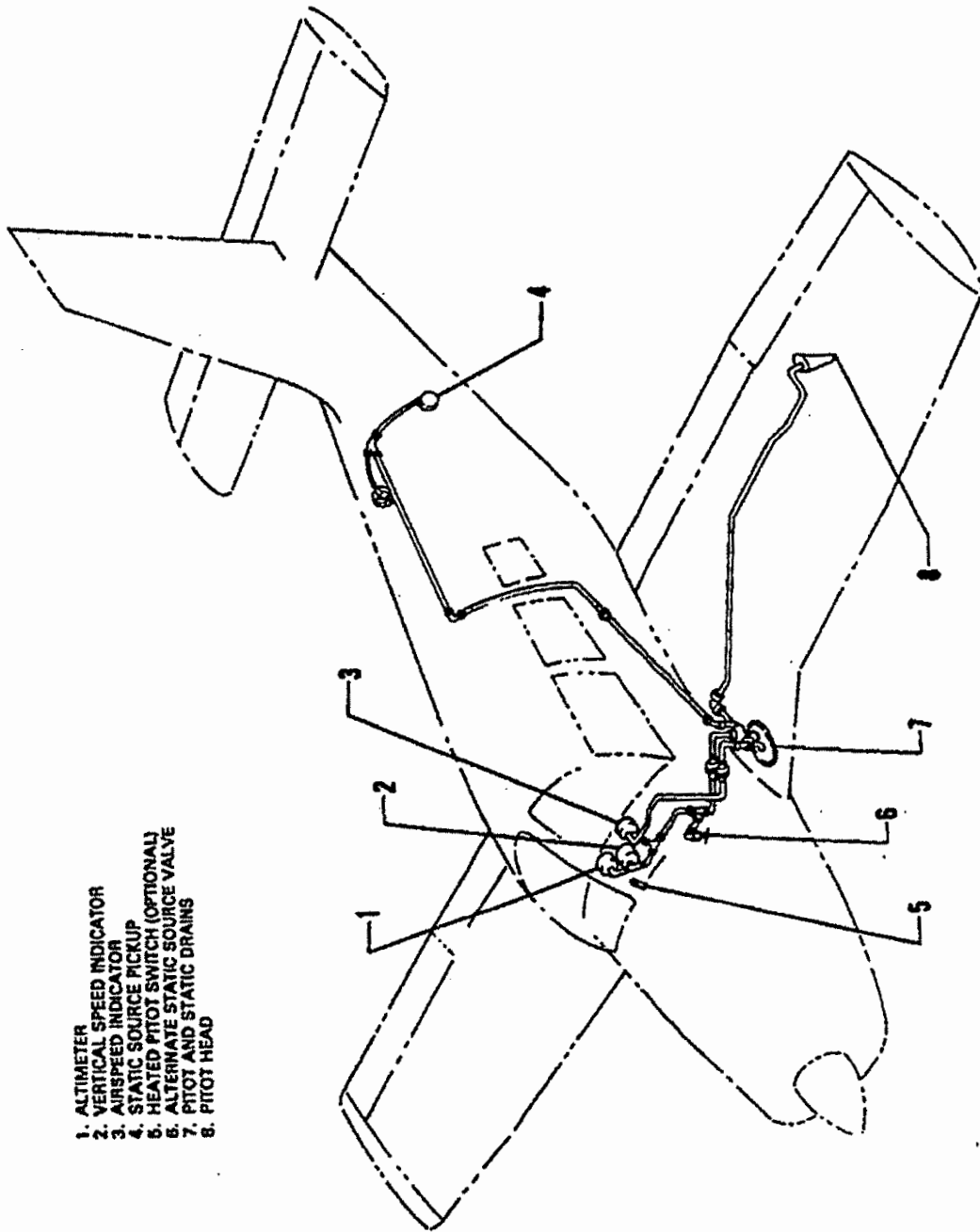

PITOT-STATIC SYSTEM  
Figure 7-19

7.23 INSTRUMENT PANEL

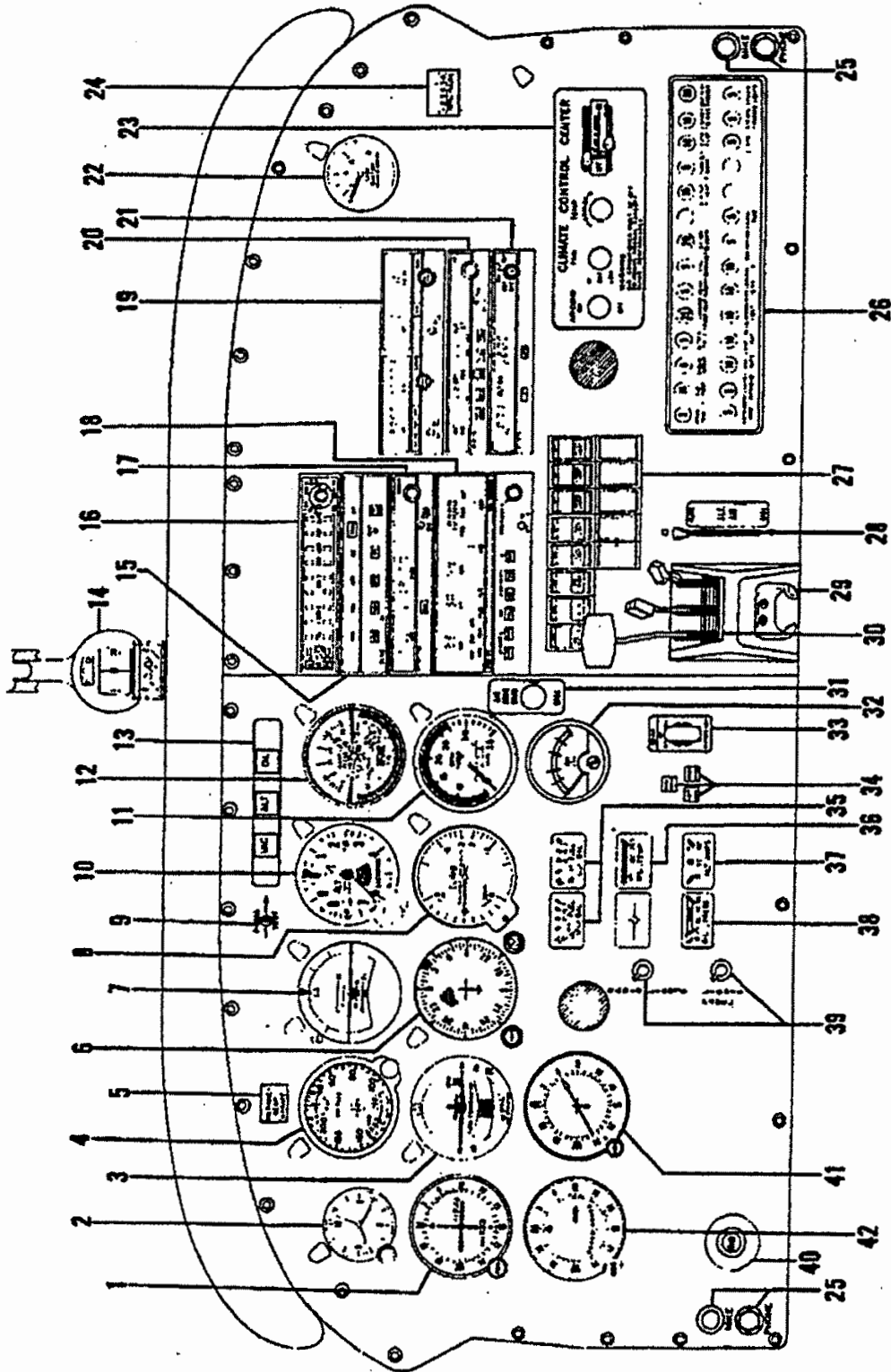

INSTRUMENT PANEL

Figure 7-21



- |  |   |  |
|--|---|--|
| 1. VOR/LOC/GLIDESLOPE INDICATOR                    | 15. AUTOPILOT                             | 29. MICROPHONE HOLDER                      |
| 2. CLOCK   | 16. AUDIO CONTROL PANEL                   | 30. ENGINE CONTROLS QUADRANT               |
| 3. TURN COORDINATOR                                | 17. COMMUNICATIONS TRANSMITTER            | 31. AIR CONDITIONER DOOR LIGHT             |
| 4. AIRSPEED INDICATOR                              | 18. AREA NAVIGATION RECEIVER              | 32. E.G.T. GAUGE                           |
| 5. WARNING - GEAR UNSAFE LIGHT                     | 19. NAVIGATION/COMMUNICATIONS TRANSMITTER | 33. LANDING GEAR SELECTOR                  |
| 6. DIRECTIONAL GYRO                                | 20. ADF RECEIVER                          | 34. LANDING GEAR POSITION                  |
| 7. ATTITUDE GYRO                                   | 21. RADAR TRANSPONDER                     | 35. LEFT AND RIGHT FUEL GAUGES             |
| 8. VERTICAL SPEED INDICATOR                        | 22. GYRO SUCTION GAUGE                    | 36. OIL TEMPERATURE GAUGE                  |
| 9. ANNUNCIATOR TEST SWITCH                         | 23. CLIMATE CONTROL CENTER                | 37. AMMETER                                |
| 10. ALTIMETER                                      | 24. HOUR METER                            | 38. OIL PRESSURE GAUGE                     |
| 11. TACHOMETER                                     | 25. MIKE/PHONE JACKS                      | 39. RADIO SWITCH/INSTRUMENT LIGHTS CONTROL |
| 12. MANIFOLD PRESSURE AND FUEL FLOW/PRESSURE GAUGE | 26. CIRCUIT BREAKERS                      | 40. IGNITION (MAGNETO) SWITCH              |
| 13. ANNUNCIATOR LIGHTS                             | 27. ELECTRICAL SWITCHES                   | 41. RADIO COMPASS (ADF)                    |
| 14. MAGNETIC COMPASS                               | 28. ALTERNATE AIR CONTROL                 | 42. VOR/LOC INDICATOR                      |

**INSTRUMENT PANEL**

Figure 7-21

ISSUED: JULY 12, 1995

REVISED: OCTOBER 7, 2004

REPORT: VB-1612

7-21

**7.23 INSTRUMENT PANEL (continued)**

The instrument panel is designed to accommodate the customary advanced flight instruments and the normally required power plant instruments. The altitude and directional gyros, located in the center of the left hand instrument panel, are vacuum operated. The vacuum gauge is located on the right hand instrument panel. The turn indicator, on the left side, is electrically operated. The optional Horizontal Situation Indicator (HSI), when installed in place of the directional gyro, is also electrically operated.

The radios are located in the center section of the panel, and the circuit breakers are in the lower right corner of the panel.

An annunciator panel is mounted in the upper instrument panel to warn the pilot of a possible malfunction in the alternator, oil pressure, or vacuum systems.

If installed, the optional radio master (RADIO MASTR) switch is located on the bottom row of the main switch panel. When the battery master (BATT MASTR) switch is turned ON, power is supplied to the avionics master relay switch, opening the contactors, and preventing current flow to the radios. When the radio master (RADIO MASTR) switch is turned ON, power is removed from the avionics master relay, allowing the contactors to spring closed, permitting current flow to the radios.

A ground clearance energy saver system is available to provide direct power to the number one communications (COMM 1) transceiver without turning on the battery master (BATT MASTR) switch and, if equipped, the radio master (RADIO MASTR) switch. An internally lit ground clearance (GND CLC) rocker switch, located on the instrument panel, provides annunciation for engagement of the system. When the switch is ON, direct airplane battery power is applied to the number one communications (COMM 1) transceiver audio amplifier (speaker) and radio accessories. During periods when the engine is shutdown, and communications is not required, the ground clearance (GND CLC) switch must be turned OFF to prevent depletion of the battery.

**CABIN DOOR LATCH**

Figure 7-23

## 7.25 CABIN FEATURES

All seat backs have three positions: normal, intermediate and recline. The adjustment lever is located at the base of the seat back on the outboard side of the seat. The front seats adjust fore and aft for ease of entry and occupant comfort. An armrest is located on the side panels adjacent to the front seat. The rear seats are easily removed to provide room for bulky items. Rear seat installations incorporate leg retainers with latching mechanisms, which must be released before the rear seats can be removed. Releasing the retainers is accomplished by depressing the plunger behind each rear leg. Optional headrests are available.

Seat occupants are protected by individual lap belts and single strap shoulder harnesses. Each shoulder harness is controlled by an inertial reel located above the side window. The shoulder strap is routed over the shoulder adjacent to the window and attached to the lap belt in the general area of the occupant's inboard hip. A check of the inertial reel mechanism can be made by pulling sharply on the strap and checking that the reel will lock in place under sudden stress; this locking feature prevents the strap from extending

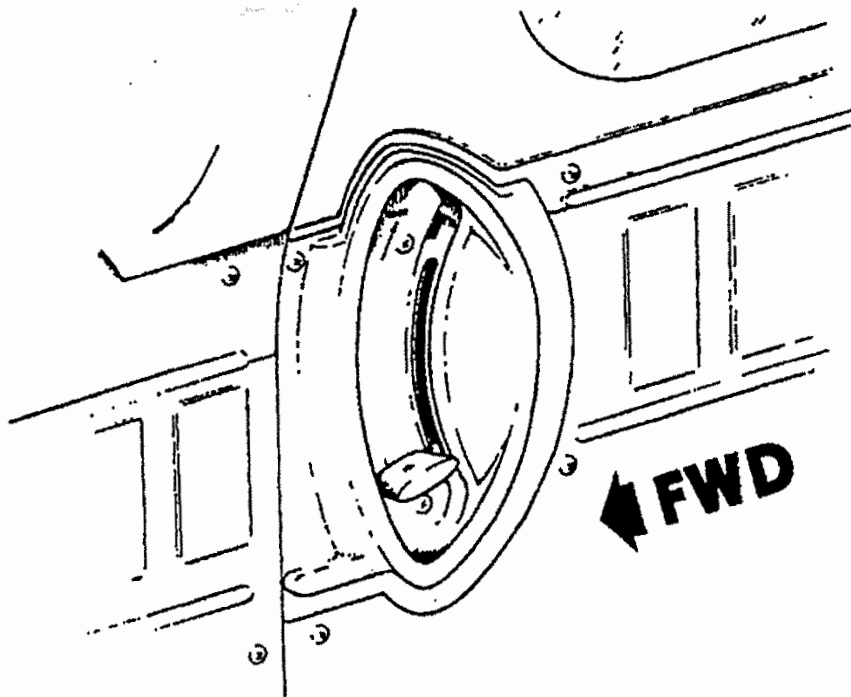
**7.25 CABIN FEATURES (continued)**

and holds the occupant in place. Under normal movement the strap will extend and retract as required. Shoulder harnesses should be routinely worn during takeoff, landing and whenever an in-flight emergency situation occurs.

Additional features include pilot storm window, two sun visors, ash trays for each occupant, map pockets located on the side panels below the instrument panel, miscellaneous pockets on the rear of the front seat backs, armrests for the front occupants, cabin or baggage door locks and ignition lock.

The Arrow cabin door is double locked. To close the cabin door, hold the door closed with the armrest while moving the side door latch to the LATCHED position; then engage the top latch. Both latches must be secured before flight.

**7.27 BAGGAGE AREA**

A large baggage area, located behind the rear seats, is accessible either from the cabin or through a large outside baggage door on the right side of the aircraft. Maximum capacity is 200 lbs. Tiedown straps are provided and should be used at all times.

**NOTE**

It is the pilot's responsibility to be sure that when baggage is loaded the aircraft C.G. falls within the allowable C.G. Range. (See Weight and Balance Section.)

## 7.29 HEATING, VENTILATING, AND DEFROSTING SYSTEM

The heating system is designed to provide maximum comfort for the occupants during winter and cool weather flights. The system includes a heat shroud, heat ducts, defroster outlets, heat and defroster controls.

### CAUTION

When cabin heat is operated, heat duct surface becomes hot. This could result in burns if arms or legs are placed too close to heat duct outlets or surface.

An opening in the front of the lower cowl admits ram air to the heater shroud and then the air is ducted to the heater shut-offs on the right and left side of the firewall. When the shut-off's are opened the heated air then enters the heat ducts located along each side of the center console. Outlets in the heat duct are located at each seat location. Airflow to the rear seats can be regulated by controls in the heat ducts located between the front seats. The temperature of the cabin is regulated by the heater control located on the right side of the instrument panel.

Defrosting is accomplished by heat outlets located on the right and left side of the cowl cover. Heated air is ducted directly to defroster shut-off valves at the firewall, then to the defroster outlets. The airflow is regulated by a defroster control located below the heat control.

To aid air distribution, the cabin air is exhausted overboard by an outlet located on the bottom of the fuselage. Cabin exhaust outlets are located below and outboard of the rear seats. The above features are removed when air conditioning is installed.

Optional individual overhead fresh air outlets supply fresh air from a louvered air inlet located on the side of the left aft fuselage beneath the dorsal fin. The air is directed to a plenum chamber at the base of the fin, then ducted to the individual outlets. For individual comfort, the amount and direction of air can be regulated to control the amount of air and direction of desired airflow. An optional blower is available which forces outside air through the overhead vents for ground use. The blower is operated by a FAN switch with three positions - OFF, LOW, or HIGH.

7.29 HEATING, VENTILATING, AND DEFROSTING SYSTEM  
(continued)

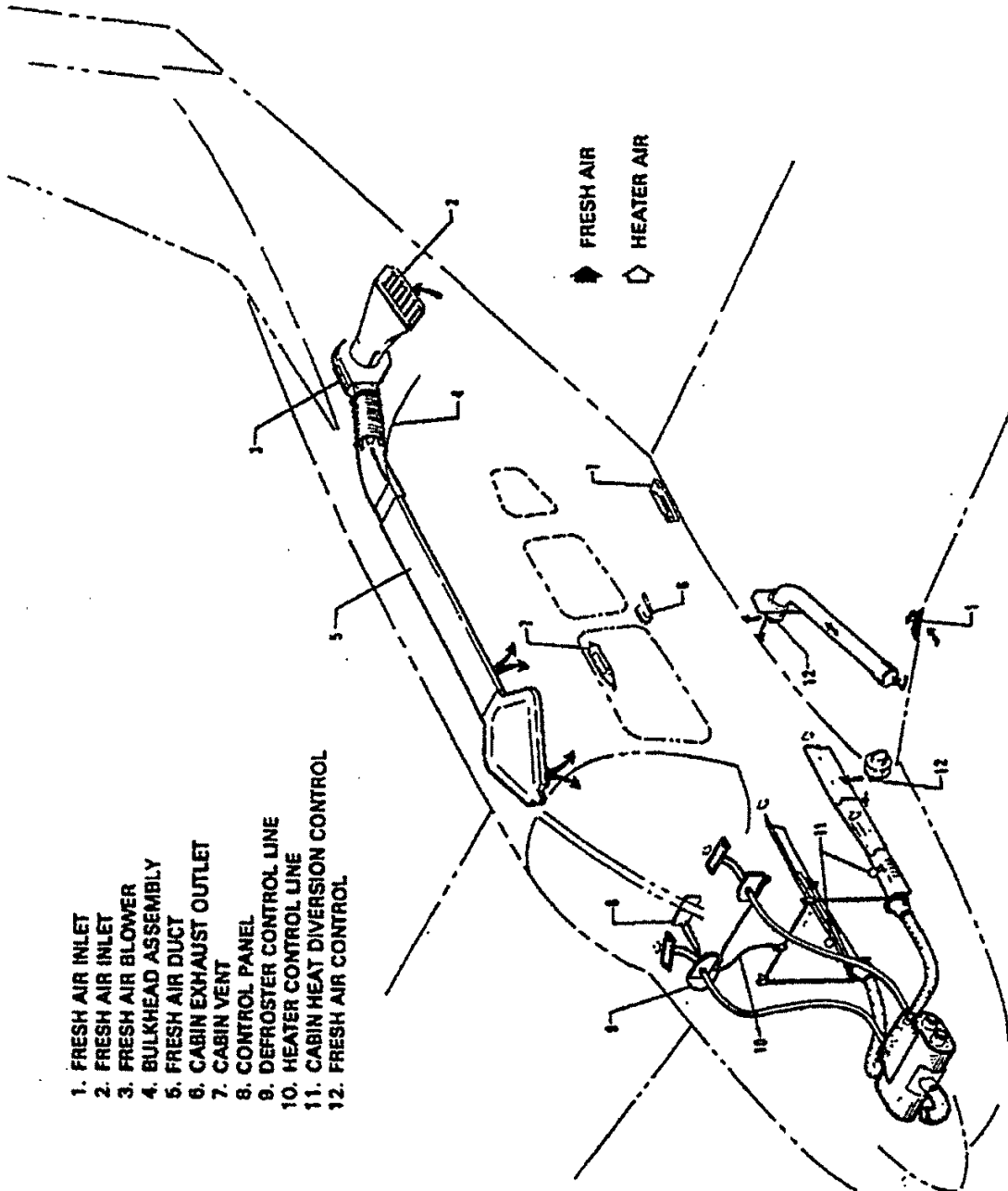

HEATING, VENTILATING AND DEFROSTING SYSTEM

Figure 7-25

### 7.31 STALL WARNING

An approaching stall is indicated by a stall warning horn which is activated between five and ten knots above stall speed. Mild airframe buffeting and gentle pitching may also precede the stall. Stall speeds are shown on graphs in the Performance Section. The stall warning horn emits a continuous sound in contrast to the gear warning horn, which emits a 90 Hz beeping sound. The stall warning horn is activated by a lift detector installed on the leading edge of the left wing. During preflight, the stall warning system should be checked by turning the battery master (BATT MASTR) switch ON, lifting the detector and checking to determine if the horn is actuated.

### 7.33 FINISH

All exterior surfaces are primed with etching primer and finished with acrylic lacquer. To keep the finish attractive looking, economy size spray cans of touchup paint are available from Piper Dealers.

### 7.35 AIR CONDITIONING\*

The air conditioning system is a recirculating air system. The major components include an evaporator, a condenser, a compressor, a blower, switches and temperature controls.

The evaporator is located on the left side of the fuselage behind the rear baggage compartment. This cools the air used for the air conditioning system.

The condenser is mounted on a retractable scoop located on the bottom of the fuselage and to the rear of the baggage compartment area. The scoop extends when the air conditioner is ON and retracts to a flush position when the system is OFF.

The compressor is mounted on the forward right underside of the engine. It has an electric clutch which automatically engages or disengages the compressor to the belt drive system of the compressor.

Air from the baggage area is drawn through the evaporator by the blower and distributed through an overhead duct to individual outlets located adjacent to each occupant.

\*Optional equipment

**7.35 AIR CONDITIONING\* (continued)**

The switches and temperature control are located on the lower right side of the instrument panel in the climate control center panel. The temperature control regulates the temperature of the cabin. Turning the control clockwise increases cooling; counterclockwise decreases cooling.

The fan speed switch and the air conditioning ON-OFF switch are inboard of the temperature control. The fan can be operated independently of the air conditioning; however, the fan must be on for air conditioner operation. Turning either switch off will disengage the compressor clutch and retract the condenser door. Cooling air should be felt within one minute after the air conditioner is turned on.

**NOTE**

If the system is not operating in 5 minutes, turn the system OFF until the fault is corrected.

The fan switch allows operation of the fan with the air conditioner turned OFF to aid in cabin air circulation. LOW or HIGH can be selected to direct a flow of air through the air conditioner outlets in the overhead duct. These outlets can be adjusted or turned off individually.

A condenser door light, located to the right of the tachometer, illuminates when the door is open and is extinguished when the door is closed.

A circuit breaker on the circuit breaker panel protects the air conditioning electrical system.

Whenever the throttle is in the full forward position, it actuates a micro switch which disengages the compressor and retracts the scoop. This allows maximum power and maximum rate of climb. The fan continues to operate and the air will remain cool for about one minute. When the throttle is retarded approximately inch, the clutch will engage, the scoop will extend, and the system will again supply cool, dry air.

\*Optional equipment



**7.37 PIPER EXTERNAL POWER\***

An optional starting installation known as Piper External Power (PEP) is accessible through a receptacle located on the right side of the fuselage aft of the baggage compartment door. An external battery can be connected to the socket, thus allowing the operator to crank the engine without having to gain access to the airplane's battery.

**7.39 EMERGENCY LOCATOR TRANSMITTER\***

The Emergency Locator Transmitter (ELT) operates on self-contained batteries and is located in the aft fuselage section. It is accessible through a rectangular cover on the right hand side. A number 2 Phillips screwdriver is required to remove the cover.

A battery replacement date is marked on the transmitter. To comply with FAA regulations, the battery must be replaced on or before this date. The battery must also be replaced if the transmitter has been used in an emergency situation or if the accumulated test time exceeds one hour, or if the unit has been inadvertently activated for an undetermined time period.

**NOTE**

If for any reason a test transmission is necessary, the test transmission should be conducted only in the first five minutes of any hour and limited to three audio sweeps. If tests must be made at any other time, the tests should be coordinated with the nearest FAA tower or flight service station.

**NARCO ELT 10 OPERATION**

On the ELT unit itself is a three position switch placarded ON, OFF and ARM. The ARM position sets the ELT so that it will transmit after impact and will continue to transmit until its battery is drained. The ARM position is selected when the ELT is installed in the airplane and it should remain in that position.

\*Optional equipment

**ISSUED: JULY 12, 1995**  
**REVISED: MAY 12, 2010**

**REPORT: VB-1612**  
**7-29**

**7.39 EMERGENCY LOCATOR TRANSMITTER\* (continued)**

**NARCO ELT 10 OPERATION (continued)**

To use the ELT as a portable unit in an emergency, remove the cover and unlatch the unit from its mounting base. The antenna cable is disconnected by a left quarter-turn of the knurled nut and a pull. A sharp tug on the two small wires will break them loose. Deploy the self-contained antenna by pulling the plastic tab marked **PULL FULLY TO EXTEND ANTENNA**. Move the switch to **ON** to activate the transmitter.

In the event the transmitter is activated by an impact, it can only be turned off by moving the switch on the ELT unit to **OFF**. Normal operation can then be restored by pressing the small clear plastic reset button located on the top of the front face of the ELT and then moving the switch to **ARM**.

A pilot's remote switch located on the left side panel is provided to allow the transmitter to be turned on from inside the cabin. The pilot's remote switch is placarded **ON** and **ARMED**. The switch is normally in the **ARMED** position. Moving the switch to **ON** will activate the transmitter. Moving the switch back to the **ARMED** position will turn off the transmitter only if the impact switch has not been activated.

The ELT should be checked to make certain the unit has not been activated during the ground check. Check by selecting 121.50 MHz on an operating receiver. If there is an oscillating chirping sound, the ELT may have been activated and should be turned off immediately. This requires removal of the access cover and moving the switch to **OFF**, then press the reset button and return the switch to **ARM**. Recheck with the receiver to ascertain the transmitter is silent.

\*Optional Equipment

**7.39 EMERGENCY LOCATOR TRANSMITTER\* (continued)**

## NARCO ELT 910 OPERATION

On the ELT unit itself is a three position switch placarded ON, OFF and ARM. The ARM position sets the ELT so that it will transmit after impact and will continue to transmit until its battery is drained. The ARM position is selected when the ELT is installed in the airplane and it should remain in that position.

A pilot's remote switch, placarded ON and ARM, is located on the left side panel to allow the transmitter to be armed or turned on from inside the cabin. The switch is normally in the ARM position. Moving the switch to ON will activate the transmitter. A warning light, located above the remote switch, will blink continuously whenever the ELT is activated.

## NOTE

The warning light will not blink if the ELT is activated by an incident that also results in severance of the airplane's power supply lines.

Should the ELT be activated inadvertently it can be reset by either positioning the remote switch to the ON position for two seconds, and then relocating it to the ARM position, or by setting the switch on the ELT to OFF and then back to ARM.

In the event the transmitter is activated by an impact, it can be turned off by moving the ELT switch OFF. Normal operation can then be restored by resetting the switch to ARM. It may also be turned off and reset by positioning the remote switch to the ON position for two seconds, and then to the ARM position.

The transmitter can be activated manually at any time by placing either the remote switch or the ELT switch to the ON position.

The ELT should be checked during postflight to make certain the unit has not been activated. Check by selecting 121.50 MHz on an operating receiver. If a downward sweeping audio tone is heard the ELT may have been activated. Set the remote switch to ON. If there is no change in the tone it is probably you. Setting the remote switch back to ARM will automatically reset the ELT.

\*Optional Equipment

**ISSUED: JULY 12, 1995**

**REPORT: VB-1612  
7-31**

**7.39 EMERGENCY LOCATOR TRANSMITTER\* (continued)**

**ARTEX ELT OPERATION**

On the ELT unit itself is a two position switch placarded ON and OFF. The OFF position is selected when the transmitter is installed at the factory and the switch should remain in that position whenever the unit is installed in the airplane.

A pilots remote switch, placarded ON and ARM is located on the copilots instrument panel to allow the transmitter to be armed or turned on from inside the cabin. The switch is normally in ARM position. Moving the switch to ON will activate the transmitter. A warning light located above the remote switch will alert you when ever the ELT is activated.

This ME-406 ELT (406 MHz), if installed, is equipped with a warning buzzer. This warning buzzer, which receives power from the ELT itself, is mounted in the tailcone. Whenever the ELT is activated the buzzer "beeps" periodically. The time between pulses lengthens after a predetermined transmitter "ON" time. The objective is to hear the buzzer from outside the aircraft while the engine is not running.

Should the ELT be activated inadvertently it can be reset by either positioning the remote switch to the ON then immediately relocating it to the ARM position, or by setting the switch on the ELT to ON and then back to OFF.

In the event the transmitter is activated by an impact, it can be turned off by moving the ELT switch OFF. Normal operation can then be restored by resetting the switch to ARM. It may also be turned off and reset by positioning the remote switch to the ON and then immediately to the ARM position.

The transmitter can be activated manually at any time by placing either the remote switch or the ELT switch to the ON position.

**NOTE:**

Three sweeps of the emergency tone and an illuminated warning light indicates a normally functioning unit. The warning light must illuminate during the first 3 second test period. If it does not illuminate, a problem is indicated such as a "G" switch failure.

The ELT should be checked during postflight to make certain the unit has not been activated. Check by selecting 121.50 MHz on an operating receiver. If a downward sweeping audio tone is heard the ELT may have been activated. Set the remote switch to ON. If there is no change in the volume of the signal, your airplane's ELT is probably transmitting. Setting the remote switch back to OFF will automatically reset the ELT and should stop the signal being received on 121.50 MHz.

TABLE OF CONTENTS

SECTION 8

AIRPLANE HANDLING, SERVICING, AND MAINTENANCE

| Paragraph No. |                                   | Page No. |
|---------------|-----------------------------------|----------|
| 8.1           | General .....                     | 8-1      |
| 8.3           | Airplane Inspection Periods ..... | 8-2      |
| 8.5           | Preventive Maintenance .....      | 8-3      |
| 8.7           | Airplane Alterations .....        | 8-3      |
| 8.9           | Ground Handling .....             | 8-4      |
| 8.11          | Engine Air Filter.....            | 8-7      |
| 8.13          | Brake Service .....               | 8-7      |
| 8.15          | Landing Gear Service.....         | 8-9      |
| 8.17          | Propeller Service .....           | 8-10     |
| 8.19          | Oil Requirements.....             | 8-10     |
| 8.21          | Fuel System.....                  | 8-10     |
| 8.23          | Tire Inflation.....               | 8-14     |
| 8.25          | Battery Service .....             | 8-15     |
| 8.27          | Cleaning .....                    | 8-15     |
| 8.29          | Winterization .....               | 8-18     |

**THIS PAGE INTENTIONALLY LEFT BLANK**

**SECTION 8****AIRPLANE HANDLING, SERVICING, AND MAINTENANCE****8.1 GENERAL**

This section provides guidelines relating to the handling, servicing, and maintenance of the Arrow. For complete maintenance instructions, refer to the PA-28R-201/201T Maintenance Manual.

**WARNING**

Inspection, maintenance and parts requirements for all non-PIPER approved STC installations are not included in this handbook. When a non-PIPER approved STC installation is incorporated on the airplane, those portions of the airplane affected by the installation must be inspected in accordance with the inspection program published by the owner of the STC. Since non-PIPER approved STC installations may change systems interface, operating characteristics and component loads or stresses on adjacent structures, PIPER provided inspection criteria may not be valid for airplanes with non-PIPER approved STC installations.

**WARNING**

Modifications must be approved in writing by PIPER prior to installation. Any and all other installations, whatsoever, of any kind will void this warranty in its entirety.

8.1 GENERAL (CONTINUED)

**WARNING**

Use only genuine PIPER parts or PIPER approved parts obtained from PIPER approved sources, in connection with the maintenance and repair of PIPER airplanes.

Genuine PIPER parts are produced and inspected under rigorous procedures to insure airworthiness and suitability for use in PIPER airplane applications. Parts purchased from sources other than PIPER, even though identical in appearance, may not have had the required tests and inspections performed, may be different in fabrication techniques and materials, and may be dangerous when installed in an airplane.

Additionally, reworked or salvaged parts or those parts obtained from non-PIPER approved sources, may have service histories which are unknown or cannot be authenticated, may have been subjected to unacceptable stresses or temperatures or may have other hidden damage not discernible through routine visual or nondestructive testing. This may render the part, component or structural assembly, even though originally manufactured by PIPER, unsuitable and unsafe for airplane use.

PIPER expressly disclaims any responsibility for malfunctions, failures, damage or injury caused by use of non-PIPER approved parts.



**8.1 GENERAL (CONTINUED)**

Every owner should stay in close contact with an authorized Piper Service Center or Piper's Customer Service Department to obtain the latest information pertaining to their airplane, and to avail themselves of Piper's support systems.

Piper takes a continuing interest in having owners get the most efficient use from their airplane and keeping it in the best mechanical condition. Consequently, Piper, from time to time, issues service releases including Service Bulletins, Service Letters, Service Spares Letters, and others relating to the airplane.

Piper Service Bulletins are of special importance and Piper considers compliance mandatory. These are available on the Piper.com website. Depending on the nature of the release, material and labor allowances may apply. This information is provided to all authorized Piper Service Centers.

Service Letters deal with product improvements and servicing techniques pertaining to the airplane. These are available on the Piper.com website. Owners should give careful attention to Service Letter information.

Service Spares Letters offer improved parts, kits, and optional equipment which were not available originally, and which may be of interest to the owner.

Maintenance manuals, parts catalogs, and revisions to both, are available from Piper Service Centers.

Any correspondence regarding the airplane should include the airplane model and serial number to ensure proper response.

### 8.3 AIRPLANE INSPECTION PERIODS

#### **WARNING**

All inspection intervals, replacement time limits, overhaul time limits, the method of inspection, life limits, cycle limits, etc., recommended by PIPER are solely based on the use of new, remanufactured or overhauled PIPER approved parts. If parts are designed, manufactured, remanufactured, overhauled and/or approved by entities other than PIPER, then the data in PIPER'S maintenance/service manuals and parts catalogs are no longer applicable and the purchaser is warned not to rely on such data for non-PIPER parts. All inspection intervals, replacement time limits, overhaul time limits, the method of inspection, life limits, cycle limits, etc., for such non-PIPER parts must be obtained from the manufacturer and/or seller of such non-PIPER parts.

Piper has developed inspection items and required inspection intervals for the PA-28R-201/201T (see the latest revision of the PA-28R-201/201T Maintenance and Inspection Manuals). The PA-28R-201/201T Inspection Manual contains appropriate forms, and all inspection procedures should be complied with by a properly trained, knowledgeable, and qualified mechanic at a Piper Authorized Service Center or a reputable repair shop. Piper cannot accept responsibility for the continued airworthiness of any aircraft not maintained to these standards, and/or not brought into compliance with applicable Service Bulletins issued by Piper, instructions issued by the engine, propeller, or accessory manufacturers, or Airworthiness Directives issued by the FAA.

A programmed Inspection, approved by the Federal Aviation Administration (FAA), is also available to the owner. This involves routine and detailed inspections to allow maximum utilization of the airplane. Maintenance inspection costs are reduced, and the maximum standard of continued airworthiness is maintained. Complete details are available from Piper.

In addition, but in conjunction with the above, the FAA requires periodic inspections on all aircraft to keep the Airworthiness Certificate in effect. The owner is responsible for assuring compliance with these inspection requirements and for maintaining proper documentation in logbooks and/or maintenance records.

A spectrographic analysis of the engine oil is available from several sources. This inspection, if performed properly, provides a good check of the internal condition of the engine. To be accurate, induction air filters must be cleaned or changed regularly, and oil samples must be taken and sent in at regular intervals.

**REPORT: VB-1612**

**8-2**

**ISSUED: JULY 12, 1995**

**REVISED: JANUARY 5, 2004**

## 8.5 PREVENTIVE MAINTENANCE

The holder of a Pilot Certificate issued under FAR Part 61 may perform certain preventive maintenance described in FAR Part 43. This maintenance may be performed only on an aircraft which the pilot owns or operates and which is not used to carry persons or property for hire, except as provided in applicable FAR's. Although such maintenance is allowed by law, each individual should make a self-analysis as to whether he has the ability to perform the work.

All other maintenance required on the airplane should be accomplished by appropriately licensed personnel.

If maintenance is accomplished, an entry must be made in the appropriate logbook. The entry should contain:

- (a) The date the work was accomplished.
- (b) Description of the work.
- (c) Number of hours on the aircraft.
- (d) The certificate number of pilot performing the work.
- (e) Signature of the individual doing the work.

## 8.7 AIRPLANE ALTERATIONS

If the owner desires to have his aircraft modified, he must obtain FAA approval for the alteration. Major alterations accomplished in accordance with Advisory Circular 43.13-2, when performed by an A & P mechanic, may be approved by the local FAA office. Major alterations to the basic airframe or systems not covered by AC 43.13-2 require a Supplemental Type Certificate.

The owner or pilot is required to ascertain that the following aircraft papers are in order and in the aircraft.

- (a) To be displayed in the aircraft at all times:
  - (1) Aircraft Airworthiness Certificate Form FAA-8100-2.
  - (2) Aircraft Registration Certificate Form FAA-8050-3.
  - (3) Aircraft Radio Station License if transmitters are installed.

### **8.7 AIRPLANE ALTERATIONS (continued)**

- (b) To be carried in the aircraft at all times:
- (1) Pilot's Operating Handbook.
  - (2) Weight and Balance data plus a copy of the latest Repair and Alteration Form FAA-337, if applicable.
  - (3) Aircraft equipment list.

Although the aircraft and engine logbooks are not required to be in the aircraft, they should be made available upon request. Logbooks should be complete and up to date. Good records will reduce maintenance cost by giving the mechanic information about what has or has not been accomplished.

### **8.9 GROUND HANDLING**

(a) Towing

The airplane may be moved on the ground by the use of the nose wheel steering bar that is stowed in the rear baggage compartment or by power equipment that will not damage or excessively strain the nose gear steering assembly. The steering bar is engaged by inserting it into the nose wheel axle.

#### **CAUTION**

When towing with power equipment, do not turn the nose gear beyond its steering radius in either direction, as this will result in damage to the nose gear and steering mechanism.

#### **CAUTION**

Do not tow the airplane when the controls are secured.

In the event towing lines are necessary, ropes should be attached to both main gear struts as high up on the tubes as possible. Lines should be long enough to clear the nose and/or tail by not less than 15 feet, and a qualified person should ride in the pilot's seat to maintain control by use of the brakes.

**8.9 GROUND HANDLING (continued)****(b) Taxiing**

Before attempting to taxi the airplane, ground personnel should be instructed and approved by a qualified person authorized by the owner. Engine starting and shutdown procedures as well as taxi techniques should be covered. When it is ascertained that the propeller back blast and taxi areas are clear, power should be applied to start the taxi roll, and the following checks should be performed:

- (1) Taxi a few feet forward and apply the brakes to determine their effectiveness.
- (2) Taxi with the propeller set in low pitch, high rpm setting.
- (3) While taxiing, make slight turns to ascertain the effectiveness of the steering.
- (4) Observe wing clearance when taxiing near buildings or other stationary objects. If possible, station an observer outside the airplane.
- (5) When taxiing over uneven ground, avoid holes and ruts.
- (6) Do not operate the engine at high rpm when running up or taxiing over ground containing loose stones, gravel, or any loose material that may cause damage to the propeller blades.

**(c) Parking**

When parking the airplane, be sure that it is sufficiently protected from adverse weather conditions and that it presents no danger to other aircraft. When parking the airplane for any length of time or overnight, it is suggested that it be moored securely.

- (1) To park the airplane, head it into the wind if possible.
- (2) Set the parking brake by pulling back on the brake lever and depressing the knob on the handle. To release the parking brake, pull back on the handle until the catch disengages; then allow the handle to swing forward.

**CAUTION**

Care should be taken when setting brakes that are overheated or during cold weather when accumulated moisture may freeze a brake.

**8.9 GROUND HANDLING (continued)**

- (3) Aileron and stabilator controls should be secured with the front seat belt and chocks used to properly block the wheels.

(d) Mooring

The airplane should be moored for immovability, security, and protection. The following procedures should be used for the proper mooring of the airplane:

- (1) Head the airplane into the wind if possible.
- (2) Retract the flaps.
- (3) Immobilize the ailerons and stabilator by looping the seat belt through the control wheel and pulling it snug.
- (4) Block the wheels.
- (5) Secure tiedown ropes to the wing tiedown rings and to the tail skid at approximately 45 degree angles to the ground. When using rope of non-synthetic material, leave sufficient slack to avoid damage to the airplane should the ropes contract.

**CAUTION**

Use bowline knots, square knots, or locked slip knots. Do not use plain slip knots.

**NOTE**

Additional preparations for high winds include using tie-down ropes from the landing gear forks and securing the rudder.

- (6) Install a pitot head cover if available. Be sure to remove the pitot head cover before flight.
- (7) Cabin and baggage doors should be locked when the airplane is unattended.

## 8.11 ENGINE AIR FILTER

### (a) Removing Engine Air Filter

- (1) Remove the upper cowl.
- (2) Remove the wing nuts securing the filter box cover. Remove the filter.

### (b) Cleaning Engine Air Filter

The induction air filter must be cleaned at least once every 50 hours, and more often, even daily, when operating in dusty conditions. Extra filters are inexpensive, and a spare should be kept on hand for use as a rapid replacement.

To clean the filter:

- (1) Tap the filter gently to remove dirt particles, being careful not to damage the filter. DO NOT wash the filter in any liquid. DO NOT attempt to blow out dirt with compressed air.
- (2) If the filter is excessively dirty or shows any damage, replace it immediately.
- (3) Wipe the filter housing with a clean cloth soaked in unleaded gasoline. When the housing is clean and dry, install the filter.

### (c) Installation of Engine Air Filter

After cleaning or when replacing the filter, install the filter in the reverse order of removal.

## 8.13 BRAKE SERVICE

The brake system is filled with MIL-H-5606 (petroleum base) hydraulic brake fluid. The fluid level should be checked periodically or at every 100-hour inspection and replenished when necessary. The brake reservoir is located on the left side of the firewall in the engine compartment. If the entire system must be refilled, fill with fluid under pressure from the brake end of the system. This will eliminate air from the system.

No adjustment of the brake clearances is necessary. If after extended service brake blocks become excessively worn, they should be replaced with new segments.

**8.13 BRAKE SERVICE (continued)**

- 1. BRAKE RESERVOIR
- 2. RIGHT BRAKE AND RUDDER PEDAL
- 3. LEFT BRAKE AND RUDDER PEDAL
- 4. RIGHT BRAKE CYLINDER
- 5. LEFT BRAKE CYLINDER
- 6. BRAKE HANDLE
- 7. HANDLE LOCKING BUTTON
- 8. LINE INLET
- 9. CLEVIS PIN
- 10. MASTER CYLINDER ASSEMBLY
- 11. BOLT ASSEMBLY
- 12. TORQUE TUBE
- 13. COPILOT'S RIGHT BRAKE AND RUDDER PEDAL
- 14. COPILOT'S LEFT BRAKE AND RUDDER PEDAL

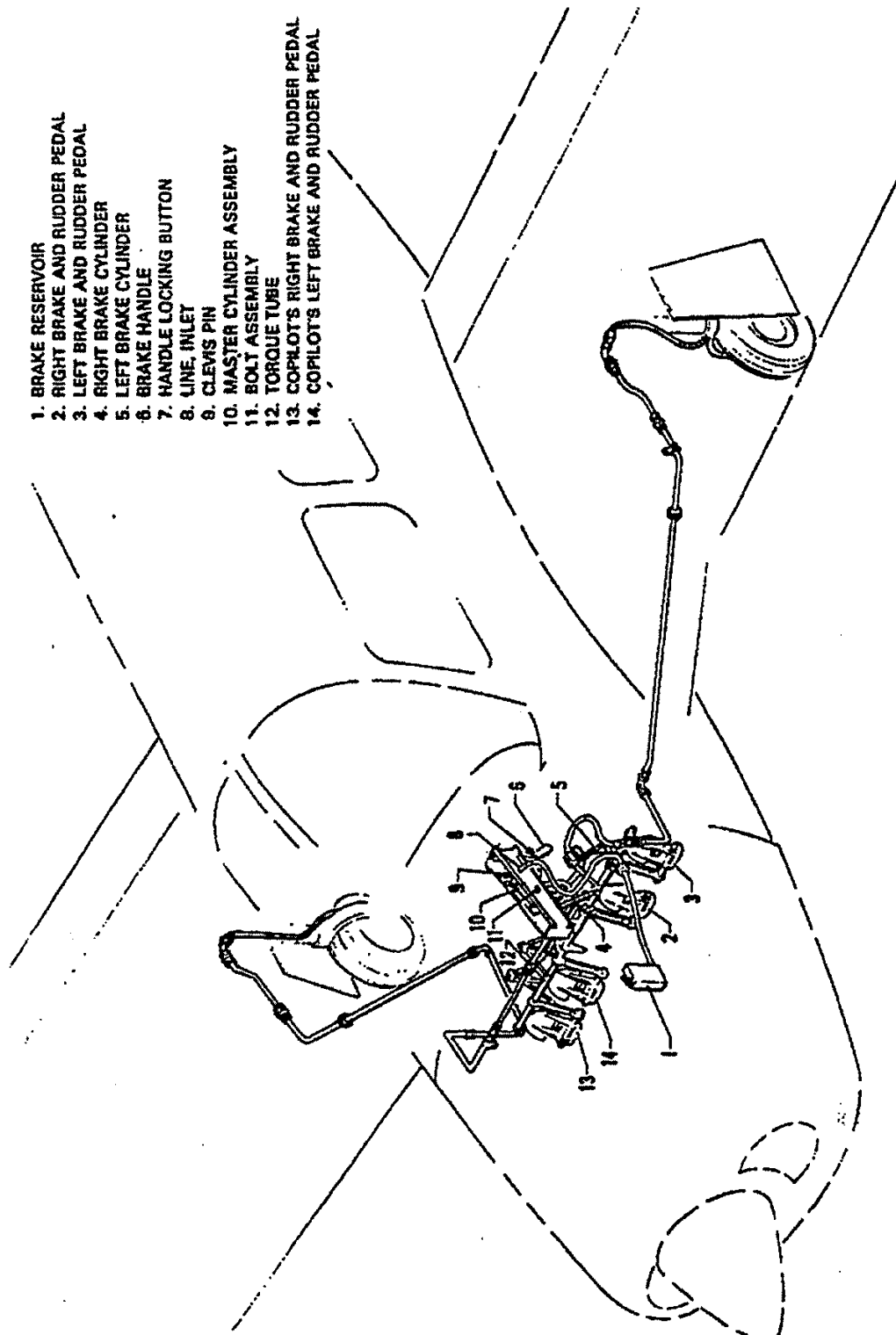

**BRAKE SYSTEM**

Figure 8-1



**8.15 LANDING GEAR SERVICE**

The main landing gear uses 6.00 x 6 wheels with 6.00 x 6, six-ply rating tires and tubes. The nose wheel uses a 5.00 x 5 wheel with a 5.00 x 5 four-ply rating, type III tire and tube. (Refer to Paragraph 8.23.)

Wheels are removed by taking off the hub cap, cotter pin, axle nut, and the two bolts holding the brake segment in place. Mark tire and wheel for reinstallation; then dismount by deflating the tire, removing the three through-bolts from the wheel, and separating the wheel halves.

Landing gear oleos on the Arrow should be serviced according to the instructions on the units. The main oleos should be extended under normal static load until 2.0 +/- 0.25 inches of oleo piston tube is exposed, and the nose gear should show 2.75 +/- 0.25 inches. To add air to the oleo struts, attach a strut pump to the valve assembly near the top of the oleo strut housing and pump the oleo to the desired position. To add oil, jack the aircraft, release the air pressure in the strut, remove the valve core, and add oil through this opening with the strut extended. After the strut is full, compress it slowly and fully to allow excess air and oil to escape. With the strut still compressed reinsert the valve stem and pump up the strut as mentioned above.

In jacking the aircraft for landing gear or other service, two hydraulic jacks and a tail stand should be used. At least 250 pounds of ballast should be placed on the base of the tail stand before the airplane is jacked up. The hydraulic jacks should be placed under the jack points on the bottom of the wing and the airplane jacked up until the tail skid is at the right height to attach the tail stand. After the tail stand is attached and the ballast added, jacking may be continued until the airplane is at the height desired.

The steering arms from the rudder pedals to the nose wheel are adjusted at the rudder pedals or at the nose wheel by turning the threaded rod end bearings in or out. Adjustment is normally accomplished at the forward end of the rods and should be done in such a way that the nose wheel is in line with the fore and aft axis of the plane when the rudder pedals and rudder are centered. Alignment of the nose wheel can be checked by pushing the airplane back and forth with the rudder centered to determine that the plane follows a perfectly straight line. The turning arc of the nose wheel is 30° in either direction and is factory adjusted at stops on the bottom of the forging.

**8.17 PROPELLER SERVICE**

The spinner and backing plate should be cleaned and inspected for cracks frequently. Before each flight the propeller should be inspected for nicks, scratches, and corrosion. If found, they should be repaired as soon as possible by a rated mechanic, since a nick or scratch causes an area of increased stress which can lead to serious cracks or the loss of a propeller tip. The back face of the blades should be painted when necessary with flat black paint to retard glare. To prevent corrosion, the surface should be cleaned and waxed periodically.

**8.19 OIL REQUIREMENTS**

The oil capacity of the Lycoming IO-360 series engine is 8 quarts, and the minimum safe quantity is 2 quarts. It is recommended that the oil be drained and renewed, and oil filter be changed, every 50 hours, or sooner under unfavorable operating conditions. The interval between oil and oil filter change is not to exceed four (4) months. The following grades are recommended for the specified temperatures:

| <u>Average Ambient<br/>Air Temperature</u> | <u>MIL-L-6082B<br/>Mineral<br/>SAE Grade</u> | <u>MIL-L-22851<br/>Ashless Dispersant<br/>SAE Grades</u> |
|--|--|--|
| All Temperatures                           | --   | 15W-50 or 20W-50   |
| Above 80°F                                 | 60   | 60   |
| Above 60°F                                 | 50   | 40 or 50   |
| 30°F to 90°F                               | 40   | 40   |
| 0°F to 70°F                                | 30   | 30, 40 or 20W-40   |
| Below 10°F                                 | 20   | 30 or 20W-30   |

When operating temperatures overlap indicated ranges, use the lighter grade oil.

**NOTE**

Refer to the latest issue of Lycoming Service Instruction 1014 (Lubricating Oil Recommendations) for further information.

**8.21 FUEL SYSTEM**

**(a) Servicing Fuel System**

At every 50-hour inspection, the fuel screen in the strainer must be cleaned. The fuel strainer is located on the forward left lower side

8.21 FUEL SYSTEM (continued)

(a) Servicing Fuel System (continued)

of the firewall. It is accessible by removing the lower cowling. After cleaning, a small amount of grease applied to the gasket will facilitate reassembly.

(b) Fuel Requirements (AVGAS ONLY)

Aviation grade fuel with a minimum octane of 100/130 is specified for this airplane. Since the use of lower grades can cause serious engine damage in a short period of time, the engine warranty is invalidated by the use of lower octanes. Refer to latest issue of Lycoming Service Instruction 1070 for approved alternate grade fuels.

Whenever 100 or 100LL grade fuel is not available, commercial grade 100/130 should be used. (See Fuel Grade Comparison Chart). Refer to the latest issue of Lycoming Service Instruction No. 1070 (Avco Lycoming Specified Fuels).

A summary of the current grades as well as the previous fuel designations is shown in the following chart:

FUEL GRADE COMPARISON CHART

| Previous Commercial Fuel Grades (ASTM-D910) |        |                      | Current Commercial Fuel Grades (ASTM-D910-75) |       |                      | Current Military Fuel Grades (MIL-G-5572F) |        |                      |
|---|--------|----------------------|---|-------|----------------------|--|--------|----------------------|
| Grade                                       | Color  | Max. TEL ml/U.S. gal | Grade   | Color | Max. TEL ml/U.S. gal | Grade                                      | Color  | Max. TEL ml/U.S. gal |
| 80/87                                       | red    | 0.5                  | 80  | red   | 0.5                  | 80/87                                      | red    | 0.5                  |
| 91/96                                       | blue   | 2.0                  | *100LL  | blue  | 2.0                  | 100/130                                    | blue   | 2.0                  |
| 100/130                                     | green  | 3.0                  | 100   | green | **3.0                | none                                       | none   | none                 |
| 115/145                                     | purple | 4.6                  | none  | none  | none                 | 115/145                                    | purple | 4.6                  |

\* -Grade 100LL fuel in some overseas countries is colored green and designated as "100L".

\*\* -Commercial fuel grade 100 and grade 100/130 having TEL content of up to 4 ml/U.S. gallons are approved for use in all engines certificated for use with grade 100/130 fuel.

**8.21 FUEL SYSTEM (continued)**

**(b) Fuel Requirements (AVGAS ONLY) (continued)**

The operation of the aircraft is approved with an anti-icing additive in the fuel. When anti-icing additive is used, it must meet the specification MIL-I-27686, must be uniformly blended with the fuel while refueling, must not exceed 0.15% by volume of the refueled quantity, and to ensure its effectiveness should be blended at not less than 0.10% by volume. One and one half liquid ozs. per ten gallons of fuel would fall within this range. A blender supplied by the additive manufacturer should be used. Except for the information contained in this section, the manufacturer's mixing or blending instructions should be carefully followed.

**CAUTIONS**

Assure that the additive is directed into the flowing fuel stream. The additive flow should start after and stop before the fuel flow. Do not permit the concentrated additive to come in contact with the aircraft painted surfaces or the interior surfaces of the tanks.

Some fuels have anti-icing additives pre-blended in the fuel at the refinery, so no further blending should be performed.

Fuel additive cannot be used as a substitute for preflight draining of the fuel system drains.

**(c) Filling Fuel Tanks**

**WARNINGS**

Do not operate any avionics or electrical equipment on the airplane during refueling. Do not allow open flame or smoking in the vicinity of the airplane while refueling.

During all refueling operations, fire fighting equipment must be available. Two ground wires from different points on the airplane to separate approved grounding stakes shall be used.

**8.21 FUEL SYSTEM (continued)****(c) Filling Fuel Tanks (continued)**

Observe all safety precautions required when handling gasoline. Fill the fuel tanks through the filler located on the forward slope of the wing. Each wing holds a maximum of 38.5 U.S. gallons. When using less than the standard 77 gallon capacity, fuel should be distributed equally between each side.

**NOTE**

Aircraft should be refueled in a wing level condition. At times this will require alternate filling of left and right tanks until the full condition is reached.

**(d) Draining Fuel Strainer, Sumps and Lines****FUEL DRAIN**

Figure 8-3

## **8.21 FUEL SYSTEM (continued)**

### **(d) Draining Fuel Strainer, Sumps and Lines (continued)**

The fuel strainer, located on the lower left side of the firewall, is provided with a quick drain which should be drained before the first flight of the day or after refueling, to check for fuel contamination. If contamination is found, fuel should be drained until the contamination stops. If contamination persists after draining fuel for a minute, contact a mechanic to check the fuel system.

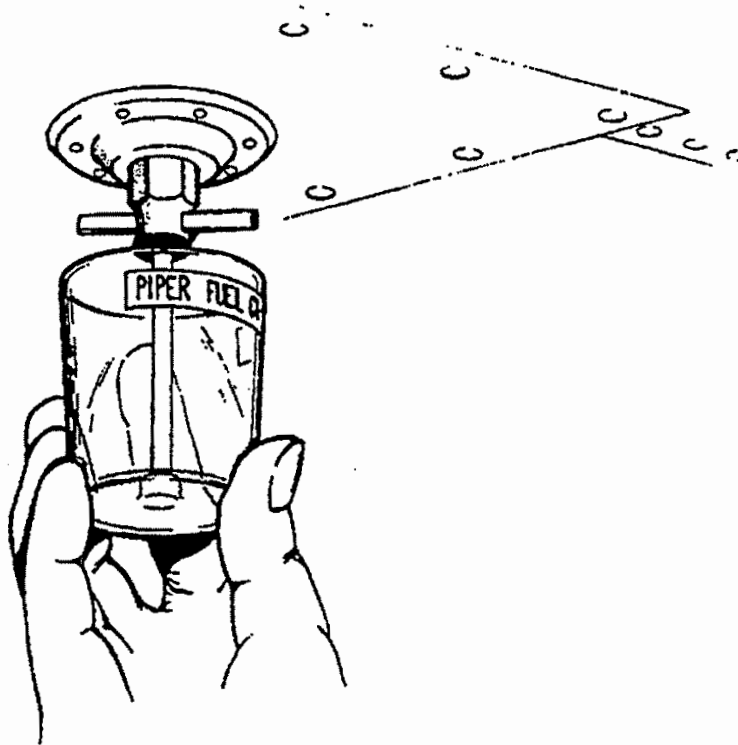
Each fuel tank is provided with a fuel quick drain to check for contamination. Each tank should be checked for contamination in accordance with the above procedure.

### **(e) Draining Fuel System**

The bulk of the fuel may be drained from the fuel cells by the use of a siphon hose placed in the cell or tank through the filler neck. The remainder of the fuel may be drained by opening all the drain valves.

### **CAUTION**

When draining fuel, be sure that no fire hazard exists before starting the engine.

## **8.23 TIRE INFLATION**

For maximum service from the tires, keep them inflated to the proper pressure of 27 psi for nose tire and 30 psi for main tires. All wheels and tires are balanced before original installation, and the relationship of tire, tube and wheel should be maintained upon reinstallation. In the installation of new components, it may be necessary to rebalance the wheels with the tires mounted. Unbalanced wheels can cause extreme vibration in the landing gear. When checking tire pressure, examine the tires for wear, cuts, bruises and slippage.

### **8.25 BATTERY SERVICE**

The 12-volt, 35-ampere-hour battery is located just behind the aft close out panel. Access is gained through the baggage compartment. The battery container has a plastic drain tube which is normally closed off with a cap. The cap should be opened periodically to remove battery acid which may have collected in the tube.

The battery fluid level must not be brought above the baffle plates. It should be checked every 30 days to determine that the fluid level is proper and the connections are tight and free of corrosion. Do not fill the battery with acid - use water only.

If the battery is not properly charged, recharge it starting with a rate of four amperes and finishing with a rate of two amperes. The battery should be removed from the airplane for charging, and quick charges are not recommended.

The external power receptacle, if installed, is located on the right side of the fuselage aft of the baggage compartment door.

Refer to the PA-28R-201/201T Maintenance Manual for battery servicing procedure.

### **8.27 CLEANING**

#### **(a) Cleaning Engine Compartment**

Before cleaning the engine compartment, place a strip of tape on the magneto vents to prevent any solvent from entering these units.

- (1) Place a large pan under the engine to catch waste.
- (2) With the engine cowling removed, spray or brush the engine with solvent or a mixture of solvent and degreaser. In order to remove especially heavy dirt and grease deposits, it may be necessary to brush areas that were sprayed.

#### **CAUTION**

Do not spray solvent into the alternator, vacuum pump, starter, or air intakes.

**8.27 CLEANING (continued)**

**(a) Cleaning Engine Compartment (continued)**

- (3) Allow the solvent to remain on the engine from five to ten minutes. Then rinse the engine clean with additional solvent and allow it to dry.

**CAUTION**

Do not operate the engine until excess solvent has evaporated or otherwise been removed.

- (4) Remove the protective tape from the magnetos.
- (5) Lubricate the controls, bearing surfaces, etc, in accordance with the Lubrication Chart.

**(b) Cleaning Landing Gear**

Before cleaning the landing gear, place a plastic cover or similar material over the wheel and brake assembly.

- (1) Place a pan under the gear to catch waste.
- (2) Spray or brush the gear area with solvent or a mixture of solvent and degreaser, as desired. Where heavy grease and dirt deposits have collected, it may be necessary to brush areas that were sprayed, in order to clean them.

**CAUTION**

Do not brush the microswitches.

- (3) Allow the solvent to remain on the gear from five to ten minutes. Then rinse the gear with additional solvent and allow to dry.
- (4) Remove the cover from the wheel and remove the catch pan.
- (5) Lubricate the gear in accordance with the Lubrication Chart.

**(c) Cleaning Exterior Surfaces**

The airplane should be washed with a mild soap and water. Harsh abrasives or alkaline soaps or detergents could make scratches on painted or plastic surfaces or could cause corrosion of metal. Cover areas where cleaning solution could cause damage. To wash the airplane, use the following procedure:

- (1) Flush away loose dirt with water.



**8.27 CLEANING (continued)****(c) Cleaning Exterior Surfaces (continued)**

- (2) Apply cleaning solution with a soft cloth, a sponge or a soft bristle brush.
- (3) To remove exhaust stains, allow the solution to remain on the surface longer.
- (4) To remove stubborn oil and grease, use a cloth dampened with naphtha.
- (5) Rinse all surfaces thoroughly.
- (6) Any good automotive wax may be used to preserve painted surfaces. Soft cleaning cloths or a chamois should be used to prevent scratches when cleaning or polishing. A heavier coating of wax on the leading surfaces will reduce the abrasion problems in these areas.

**(d) Cleaning Windshield and Windows**

- (1) Remove dirt, mud and other loose particles from exterior surfaces with clean water.
- (2) Wash with mild soap and warm water or with aircraft plastic cleaner. Use a soft cloth or sponge in a straight back and forth motion. Do not rub harshly.
- (3) Remove oil and grease with a cloth moistened with kerosene.

**CAUTION**

Do not use gasoline, alcohol, benzene, carbon tetrachloride, thinner, acetone, or window cleaning sprays.

- (4) After cleaning plastic surfaces, apply a thin coat of hard polishing wax. Rub lightly with a soft cloth. Do not use a circular motion.
- (5) A severe scratch or mar in plastic can be removed by rubbing out the scratch with jeweler's rouge. Smooth both sides and apply wax.

**8.27 CLEANING (continued)**

**(e) Cleaning Headliner, Side Panels and Seats**

- (1) Clean headliner, side panels, and seats with a stiff bristle brush, and vacuum where necessary.
- (2) Soiled upholstery, except leather, may be cleaned with a good upholstery cleaner suitable for the material. Carefully follow the manufacturer's instructions. Avoid soaking or harsh rubbing.

**CAUTION**

Solvent cleaners require adequate ventilation.

- (3) Leather should be cleaned with saddle soap or a mild hand soap and water.

**(f) Cleaning Carpets**

To clean carpets, first remove loose dirt with a whisk broom or vacuum. For soiled spots and stubborn stains use a nonflammable dry cleaning fluid. Floor carpets may be cleaned like any household carpet.

**8.29 WINTERIZATION**

For winter operation a winterization kit is installed on the inlet opening of the oil cooler outboard chamber of the plenum chamber. This kit should be installed whenever the ambient temperature is 50F or less. When the kit is not being used it can be stowed on the bracket provided for this purpose on the top side of the oil cooler plenum chamber.

## TABLE OF CONTENTS

SECTION 9  
SUPPLEMENTS

| Paragraph/Supplement<br>No. |  | Page<br>No. |
|-----------------------------|--|-------------|
| 9.1                         | General.....   | 9-1         |
| 1                           | Auxiliary Vacuum System .....(6 pages)   | 9-3         |
| 2                           | King 100 Series Flight Control System (Deleted).....(1 page)   | 9-9         |
| 3                           | King 150 Series Flight Control System (Deleted).....(1 page)   | 9-11        |
| 4                           | Bendix/King KLN 89B GPS Navigation System .....(12 pages)  | 9-13        |
| 5                           | Bendix/King KX 155A Comm/Nav System.....(12 pages)   | 9-25        |
| 6                           | S-TEC Manual Electric Trim System.....   | 9-37        |
| 7                           | Garmin GNS 430 Nav/Com/GPS .....(8 pages)  | 9-39        |
| 8                           | Garmin GTX 327 Transponder .....(10 pages)   | 9-47        |
| 9                           | S-TEC ADF 650 System.....(6 pages)   | 9-57        |
| 10                          | Garmin GMA 340 Audio Panel .....(6 pages)  | 9-63        |
| 11                          | S-TEC DME 450.....(4 pages)  | 9-69        |
| 12                          | S-TEC System 55 Autopilot.....   | 9-73        |
| 13                          | S-TEC System 55X Autopilot.....  | 9-75        |
| 14                          | S-TEC ADF 650D System.....(10 pages)   | 9-77        |
| 15                          | Garmin GTX 330 Transponder .....(4 pages)  | 9-87        |
| 16                          | Avidyne FlightMax Entegra Primary<br>Flight/Multi-Function Displays .....(30 pages)  | 9-91        |
| 17                          | Mid-Continent 4300-4XX Series<br>Electric Attitude Indicator .....(4 pages)  | 9-119       |
| 18                          | Avidyne FlightMax Entegra Primary<br>Flight/Multi-Function Displays With<br>The B&C Specialties BC410<br>Standby Alternator.....(36 pages) | 9-123       |

**TABLE OF CONTENTS**

**SECTION 9  
SUPPLEMENTS  
(continued)**

| Paragraph/Supplement No. |   | Page No. |
|--------------------------|---|----------|
| 19.                      | Bendix/King KR-87 Digital ADF with<br>KI-227 Indicator .....(10 pages)                        | 9-159    |
| 20.                      | Bendix/King KN-63 DME .....(4 pages)  | 9-169    |
| 21.                      | Garmin GNS 430W VHF Communication<br>Transceiver/VOR/ILS Receiver/GPS Receiver.....(12 pages) | 9-173    |
| 22.                      | Garmin G500 Primary Flight and Multifunction<br>Display System.....(1 page)                   | 9-185    |

**SECTION 9  
SUPPLEMENTS**

**9.1 GENERAL**

This section provides information in the form of Supplements which are necessary for efficient operation of the airplane when equipped with one or more of the various optional systems and equipment not provided with the standard airplane.

All of the Supplements provided by this section are FAA Approved and consecutively numbered as a permanent part of this Handbook. The information contained in each Supplement applies only when the related equipment is installed in the airplane.

**THIS PAGE INTENTIONALLY LEFT BLANK**

**PILOT'S OPERATING HANDBOOK  
AND  
FAA APPROVED AIRPLANE FLIGHT MANUAL  
SPECIAL SUPPLEMENT  
FOR  
OPERATION IN THE UNITED KINGDOM**

Serial Number: 2844120

Registration Number: N30645

This supplement must be attached to the Pilot's Operating Handbook and FAA Approved Airplane Flight Manual and contains the information necessary for operation of the PA-28R-201, Arrow in the United Kingdom under C.A.A. regulations. The information contained herein supplements or supersedes the information in the basic Pilot's Operating Handbook and FAA Approved Airplane Flight Manual only in those areas listed herein. For information not contained in this supplement, consult the basic Pilot's Operating Handbook and FAA Approved Airplane Flight Manual.

FAA APPROVED

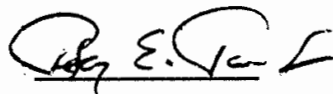

PETER E. PECK  
D.O.A. NO. SO-1  
THE NEW PIPER AIRCRAFT, INC.  
VERO BEACH, FLORIDA

DATE OF APPROVAL SEPTEMBER 19, 1999

ISSUED: SEPTEMBER 19, 1999

REPORT: VB-1733  
PAGE: TITLE

**THIS PAGE INTENTIONALLY LEFT BLANK**



**PILOT'S OPERATING HANDBOOK LOG OF REVISIONS**

Current Revisions to the PA-28R-201 Arrow, UK Supplement, VB-1733, issued September 19, 1999.

| Revision Number and Code | Revised Pages  | Description of Revisions                               |
|--------------------------|----------------|--|
| Rev. 1<br>(PR010417)     | ii<br>iii<br>4 | Revised page.<br>Revised page.<br>Revised Limitations. |

| Revision<br>Number and<br>Code | Revised<br>Pages | Description of Revisions |
|--------------------------------|------------------|--------------------------|
|                                |                  |                          |

**REPORT: VB-1733**

**iii**

**ISSUED: SEPTEMBER 19, 1999**

**REVISED: APRIL 17, 2001**

## INTRODUCTION

The data in this supplement must be included in the Pilot's Operating Handbook (P.O.H.) when operating on the United Kingdom register. In cases of conflicting information, the data in this supplement supercedes information published in VB-1612.

## LIMITATIONS

### Category:

Aircraft of this type are eligible for certification in the Transport Category (Passenger). However, this aeroplane may be restricted to a particular use of some other category, which will be stated in the Certificate of Airworthiness.

### Performance:

When certificated in the Transport Category (Passenger) the aeroplane is classified in Performance Group E. It must be operated in accordance with the performance data in the Pilot's Operating Handbook Report VB-1612 except that autopilot minimum altitudes must be obtained from the information in this supplement. Only figures 5-13 and 5-15 shall be used for take off performance. Short field effect take off performance, figures 5-9 and 5-11 must not be used for public transport flights.

## LIMITATIONS (Cont'd.)

### Performance (Cont'd.)

For take off operations from short dry grass fields with firm subsoil, increase take off distance by 20%. For take off operations from short wet grass fields, with firm subsoil, increase take off distance by 25%. These factors apply to take off distance to 50 feet - the effect on the ground roll will be greater.

For landing operations from short dry grass fields with firm subsoil, increase landing distance by 20%. For landing operations from short wet grass fields with firm subsoil, increase landing distance by 30%. These factors apply to landing distance from 50 feet. The wind correction grids are factored so that 50% of headwinds and 150% of tailwinds are obtained. The reported winds may, therefore, be used directly in the grids.

### Flight Over Water Speed:

The representative cruising true airspeed for flight over water is 120 knots.

### Minimum Crew:

The minimum crew is one pilot.

**LIMITATIONS (Cont'd.)****Number of Occupants:**

The number of persons carried must not exceed four, nor exceed the number of seats installed. Children under the age of 2, carried in the arms of passengers, are excluded from this count.

**Climatic Conditions:**

The operating suitability of the aeroplane has been established for temperatures up to the range defined by I.S.A. +22° C.

A minimum temperature has not been established.

**Type of Operation:**

Flying VFR and IFR during day or night is permitted when the required equipment is installed and when allowed by the Air Navigation Regulations.

When flying above 10,000 feet, it is the pilot's responsibility to consider the physical limitations of the pilot and passengers, oxygen equipment required and compliance with all applicable Air Navigation Regulations.

## LIMITATIONS (Cont'd.)

### Autopilots:

When a Bendix/King 150 series autopilot, or an S-TEC System 55/55X autopilot is installed, it shall *not* remain engaged at heights below 1000 feet above the terrain. When coupled to an ILS glide slope, it shall *not* remain engaged at heights below 200 ft above the terrain.

### Equipment:

Operation of this aircraft is not approved without the following listed equipment installed and operational.

1. Starter Engaged Light
2. Low Voltage Monitor Light

## PROCEDURES

### Starter Engaged Warning Light:

A "STARTER ENGAGED" warning light is installed on the pilot's side of the instrument panel. This warning light illuminates when the starter switch is engaged and extinguishes when the starter switch is disengaged.

**PROCEDURES** (Cont'd.)Starter Engaged Warning Light: (Cont'd)

Should the warning light remain illuminated after the starter switch is disengaged, turn the BATTERY MASTER SWITCH OFF and have the fault corrected before attempting to start the engine.

Low Voltage Monitor Light

## Pre Flight Check:

## Before Engine Start

|                        |     |
|------------------------|-----|
| Alternator             | Off |
| Battery Master         | On  |
| Low Voltage Warn Light | On  |

## Emergency Procedure

|                        |            |
|------------------------|------------|
| Low Voltage Warn Light | On         |
| Alternator (Ammeter)   | Check Zero |
| If Zero, Alternator    | Off        |

**PROCEDURES** (Cont'd.)

## Notes:

- A. A landing should be made as soon as possible. Under the alternator failure conditions the battery endurance should be 30 minutes.
- B. VHF communication transmission should be restricted to maximum of 3 minutes during total flight.
- C. Other electrical services may be used at the pilot discretion but the battery endurance will be reduced prorata.



**PILOT'S OPERATING HANDBOOK  
AND  
FAA APPROVED AIRPLANE FLIGHT MANUAL**

**SUPPLEMENT 1  
FOR  
AUXILIARY VACUUM SYSTEM**

This supplement must be attached to the Pilot's Operating Handbook and FAA Approved Airplane Flight Manual when the Piper Auxiliary Vacuum System is installed in accordance with Piper Drawing No. 89311-2. The information contained herein supplements or supersedes the basic Pilot's Operating Handbook and FAA Approved Airplane Flight Manual only in those areas listed herein. For limitations, procedures and performance information not contained in this supplement, consult the basic Pilot's Operating Handbook and FAA Approved Airplane Flight Manual.

FAA APPROVED:

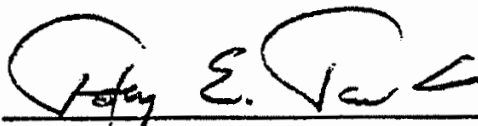

PETER E. PECK  
D.O.A. NO. SO-1  
THE NEW PIPER AIRCRAFT, INC.  
VERO BEACH, FLORIDA

DATE OF APPROVAL: July 12, 1995

ISSUED: JULY 12, 1995

REPORT: VB-1612

1 of 6 9-3

**SECTION 1 - GENERAL**

This supplement supplies information necessary for the operation of the airplane when the optional Piper Auxiliary Vacuum System is installed. The information contained within this supplement is to be used in conjunction with the complete handbook.

**SECTION 2 - LIMITATIONS**

- (a) The auxiliary vacuum system is limited to standby function only, do not take off with the engine driven dry air pump inoperative.
- (b) Discontinue flight in Instrument Meteorological Conditions (IMC) if vacuum pressure falls below 4.8 In. Hg.
- (c) The auxiliary pump/motor assembly and elapsed time indicator must be removed from service after 500 hours accumulated operating time or 10 years whichever occurs first.

**SECTION 3 - EMERGENCY PROCEDURES**

- (a) VAC OFF or Low VAC Warning illuminated - Auxiliary Vacuum Switch AUX ON.
- (b) Verify vacuum system suction is 4.8 to 5.2 In. Hg., VAC OFF annunciator is extinguished, and AUX ON annunciator illuminated.

**CAUTION**

Compass error may exceed 10° when auxiliary vacuum system is in operation.

- (c) Monitor electrical load - verify alternator capacity is not being exceeded as indicated by the ammeter. If required, turn off nonessential electrical equipment.
- (d) Land at the earliest opportunity to have primary system repaired.

**SECTION 4 - NORMAL PROCEDURES**

**(a) Preflight Check.**

- (1) Turn battery master (BATT MASTR) switch ON and verify that the VAC OFF light is illuminated.

**NOTE**

Due to the electrical power requirement of the auxiliary vacuum pump it is suggested that the engine be operating while making the following checks.

- (2) Turn the auxiliary vacuum pump ON and verify that the AUX ON light is illuminated and an electrical load increase of approximately 15 amps on the ammeter.
- (3) Turn off the auxiliary vacuum pump and verify that the AUX ON light has extinguished.

**(b) Inflight Check.**

- (1) Turn off non-essential electrical equipment.
- (2) Turn the auxiliary vacuum pump ON and verify that the AUX ON light is illuminated and an electrical load increase of approximately 15 amps on ammeter.
- (3) Turn off auxiliary vacuum pump and verify that the AUX ON light has extinguished and resume normal flight using engine driven pump.

**NOTE**

For maximum service life, avoid continuous non-emergency operation of the auxiliary vacuum pump.

**SECTION 5 - PERFORMANCE**

No change.

**SECTION 6 - WEIGHT & BALANCE**

Factory installed optional equipment is included in the licensed weight and balance data in Section 6 of the Basic Pilot's Operating Handbook.

**SECTION 7 - DESCRIPTION AND OPERATION**

The auxiliary dry air pump system provides an independent back-up source of pneumatic power to operate the gyro flight instruments in the event the engine driven air pump fails.

The auxiliary pump is mounted on the forward side of the firewall and connects to the primary system at a manifold downstream of the vacuum regulator. Isolation of the primary and auxiliary systems from each other is accomplished by check valves on each side of the manifold. The primary system vacuum switch is located in the center of the manifold and senses vacuum supplied to the gyros.

The control switch (labeled AUX VAC) for the auxiliary pump system is located on the main electrical switch panel in the center of the instrument panel above the throttle quadrant. The control switch operating modes are push-for-on and push-for-off.

The switch button incorporates two annunciator light sections labeled VAC OFF and AUX ON. The VAC OFF section is controlled by a vacuum switch in the primary pneumatic system and illuminates an amber light when the engine driven pump is inoperative or when the system vacuum falls below the switch activation level. The AUX ON section is controlled by a vacuum switch in the auxiliary pneumatic system and illuminates a blue light when the auxiliary pump is operating and creating a vacuum in the system. When the auxiliary pump is activated at high altitude, or if the system has developed air leaks, the AUX ON light may fail to illuminate. This indicates that the system vacuum is still below the AUX ON switch activation level even though the auxiliary pump is operating and can be verified by observing the vacuum system indicator.

**SECTION 7 - DESCRIPTION AND OPERATION (cont)**

The annunciator lights do not incorporate a press-to-test feature. If the lights do not illuminate as expected, check for burned out lamps, replace with MS 25237-330 bulbs and retest the system.

The pump motor electrical circuit is protected by a 20 amp AUX VAC breaker installed in the circuit breaker panel. The switch annunciator light is protected by a 5 amp in-line fuse.

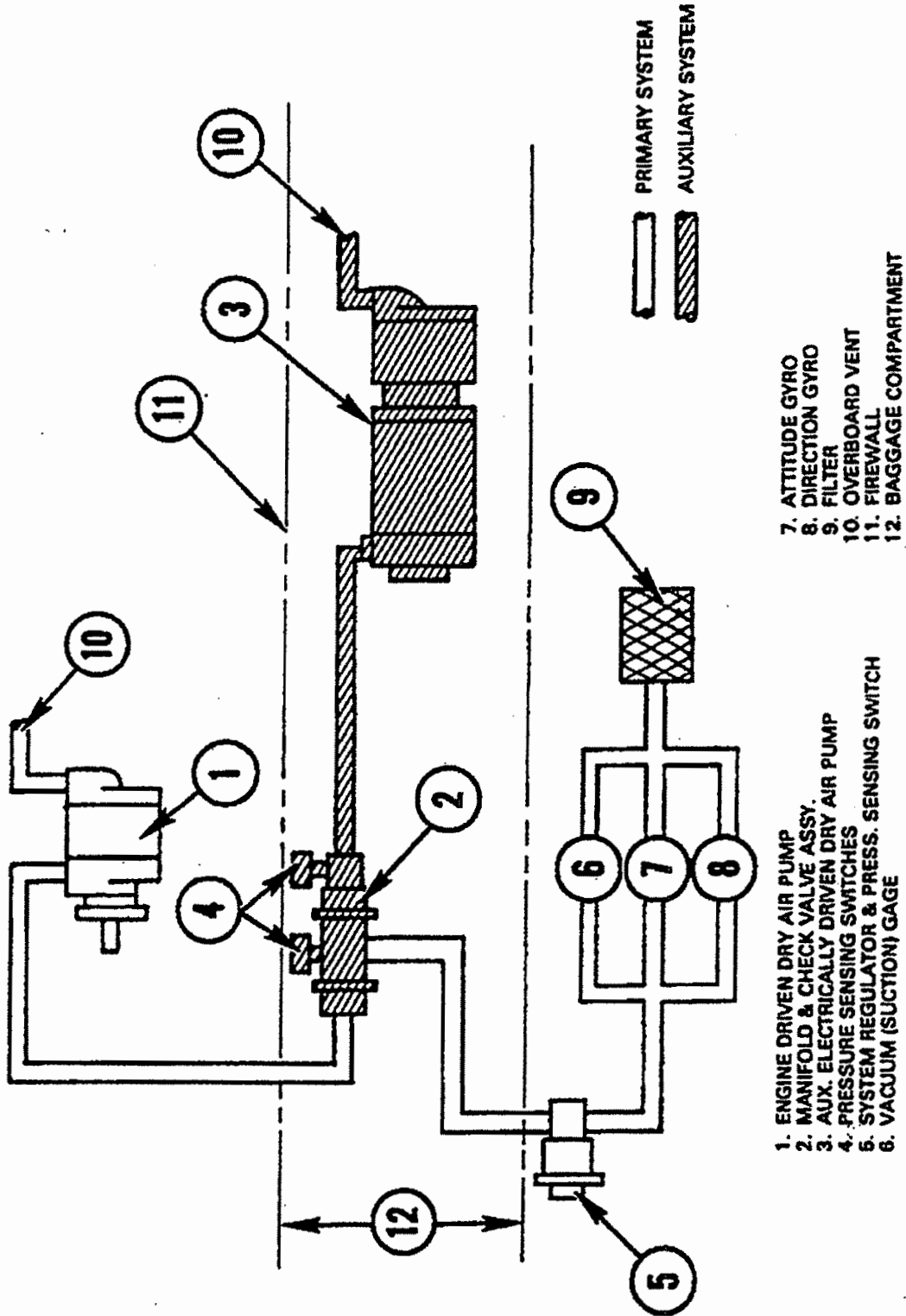

VACUUM SYSTEM SCHEMATIC

**PILOT'S OPERATING HANDBOOK  
AND  
FAA APPROVED AIRPLANE FLIGHT MANUAL  
  
SUPPLEMENT NO. 2  
FOR  
KING 100 SERIES FLIGHT CONTROL SYSTEM**

The FAA Approved Operational Supplement to the Bendix/King 100 Series Flight Control System as installed per STC SA1563CE-D is supplied by the autopilot manufacturer. Bendix/King will be responsible to supply and revise the operational supplement. It is permitted to include the Bendix/King supplement in this location of the Pilots Operating Handbook unless otherwise stated by Bendix/King. The information contained in the Bendix/King supplement may supersede or supplement the information in the basic Pilot's Operating Handbook and FAA Approved Airplane Flight Manual with respect to the operation of the autopilot. For limitations, procedures and performance information not contained in the Bendix/King supplement, consult the basic Pilot's Operating Handbook and FAA Approved Airplane Flight Manual.

**ISSUED: JULY 12, 1995**

**REPORT: VB-1612  
9-9**

**THIS PAGE INTENTIONALLY LEFT BLANK**



**PILOT'S OPERATING HANDBOOK  
AND  
FAA APPROVED AIRPLANE FLIGHT MANUAL  
  
SUPPLEMENT NO. 3  
FOR  
KING 150 SERIES FLIGHT CONTROL SYSTEM**

The FAA Approved Operational Supplement to the Bendix/King 150 Series Flight Control System as installed per STC SA1563CE-D is supplied by the autopilot manufacturer. Bendix/King will be responsible to supply and revise the operational supplement. It is permitted to include the Bendix/King supplement in this location of the Pilots Operating Handbook unless otherwise stated by Bendix/King. The information contained in the Bendix/King supplement may supersede or supplement the information in the basic Pilot's Operating Handbook and FAA Approved Airplane Flight Manual with respect to the operation of the autopilot. For limitations, procedures and performance information not contained in the Bendix/King supplement, consult the basic Pilot's Operating Handbook and FAA Approved Airplane Flight Manual.

**ISSUED: JULY 12, 1995**

**REPORT: VB-1612  
9-11**

**THIS PAGE INTENTIONALLY LEFT BLANK**

**PILOT'S OPERATING HANDBOOK  
AND  
FAA APPROVED AIRPLANE FLIGHT MANUAL**

**SUPPLEMENT NO. 4  
FOR  
BENDIX/KING KLN 89B GPS  
NAVIGATION SYSTEM**

This supplement must be attached to the Pilot's Operating Handbook and FAA Approved Airplane Flight Manual when the KLN 89B GPS Navigation System is installed per the Equipment List. The information contained herein supplements or supersedes the Pilot's Operating Handbook and FAA Approved Airplane Flight Manual only in those areas listed herein. For limitations, procedures and performance information not contained in this supplement, consult the Pilot's Operating Handbook and FAA Approved Airplane Flight Manual.

FAA APPROVED:

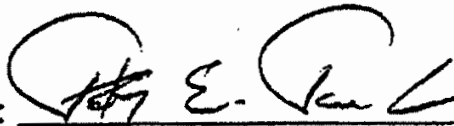

**PETER E. PECK  
D.O.A. NO. SO-1  
THE NEW PIPER AIRCRAFT, INC.  
VERO BEACH, FLORIDA**

DATE OF APPROVAL: December 11, 1995

**ISSUED: JULY 12, 1995  
REVISED: DECEMBER 11, 1995**

**REPORT: VB-1612  
1 of 12 9-13**

**SECTION 1 GENERAL**

The KLN 89B GPS panel mounted unit contains the GPS sensor, the navigation computer, a CRT display, and all controls required to operate the unit. It also houses the data base card which plugs directly into the front of the unit.

The data base card is an electronic memory containing information on airports, nav aids, intersections, SID's, STAR's, instrument approaches, special use airspace, and other items of value to the pilot.

Every 28 days, Bendix/King receives new data base information from Jeppesen Sanderson for the North American data base region. This information is processed and downloaded onto the data base cards. Bendix/King makes these data base card updates available to KLN 89B GPS users.

Provided the KLN 89B GPS navigation system is receiving adequate usable signals, it has been demonstrated capable of and has been shown to meet the accuracy specifications of:

VFR/IFR en route oceanic and remote, en route domestic, terminal, and instrument approach (GPS, Loran-C, VOR, VOR-DME, TACAN, NDB, NDB-DME, RNAV) operation within the U.S. National Airspace System, North Atlantic Minimum Navigation Performance Specifications (MNPS) Airspace and latitudes bounded by 74° North and 60° South using the WGS44 (or NAD 83) coordinate reference datum in accordance with the criteria of AC 20-138, AC 91-49, and AC 120-33. Navigation data is based upon use of only the global positioning system (GPS) operated by the United States.

**NOTE**

Aircraft using GPS for oceanic IFR operations may use the KLN 89B to replace one of the other approved means of long-range navigation. A single KLN 89B GPS installation may also be used on short oceanic routes which require only one means of longrange navigation.

**NOTE**

FAA approval of the KLN 89B does not necessarily constitute approval for use in foreign airspace.

**SECTION 2- LIMITATIONS**

A. The KLN 89B GPS Pilot's Guide, P/N 006-08786-0000, dated May, 1995 (or later applicable revision) must be immediately available to the flight crew whenever navigation is predicated on the use of the system. The Operational Revision Status (ORS) of the Pilot's Guide must match the ORS level annunciated on the Self Test page.

B. IFR Navigation is restricted as follows:

1. The system must utilize ORS level 01 or later FAA approved revision.

2. The data on the self test page must be verified prior to use.

3. IFR en route and terminal navigation is prohibited unless the pilot verifies the currency of the data base or verifies each selected waypoint for accuracy by reference to current approved data.

4. Instrument approaches must be accomplished in accordance with approved instrument approach procedures that are retrieved from the KLN 89B data base. The KLN 89B data base must incorporate the current update cycle.

(a) The KLN 89B Quick Reference, P/N 006-08787-0000, dated 5/95 (or later applicable revision) must be immediately available to the flight crew during instrument approach operations.

(b) Instrument approaches must be conducted in the approach mode and RAIM must be available at the Final Approach Fix.

(c) APR ACTV mode must be annunciated at the Final Approach Fix.

(d) Accomplishment of ILS, LOC, LOC-BC, LDA, SDF, and MLS approaches are not authorized.

(e) When an alternate airport is required by the applicable operating rules, it must be served by an approach based on other than GPS or Loran-C navigation.

(f) The KLN 89B can only be used for approach guidance if the reference coordinate datum system for the instrument approach is WGS 84 or NAD-83. (All approaches in the KLN 89B data base use the WGS-84 or the NAD-83 geodetic datums.)

5. The aircraft must have other approved navigation equipment appropriate to the route of flight installed and operational.

**ISSUED: JULY 12, 1995**  
**REVISED: DECEMBER 11, 1995**

**REPORT: VB-1612**  
**3 of 12 9-15**

**SECTION 3- EMERGENCY PROCEDURES  
PROCEDURES**

**ABNORMAL**

- A. If the KLN 89B GPS information is not available or invalid, utilize remaining operational navigation equipment as required.
- B. If a "RAIM NOT AVAILABLE" message is displayed while conducting an instrument approach, terminate the approach. Execute a missed approach if required.
- C. If a "RAIM NOT AVAILABLE" message is displayed in the en route or terminal phase of flight, continue to navigate using the KLN 89B or revert to an alternate means of navigation appropriate to the enroute and terminal phase of flight. When continuing to use GPS navigation, position must be verified every 15 minutes using another IFR approved navigation system.
- D. Refer to the KLN 89B Pilot's Guide, Appendices B and C, for appropriate pilot actions to be accomplished in response to annunciated messages.

**SECTION 4 - NORMAL PROCEDURES**

**WARNING**

Familiarity with the en route operation of the KLN 89B does not constitute proficiency in approach operations. Do not attempt approach operations in IMC prior to attaining proficiency in the use of the KLN 89B.

**A. OPERATION**

Normal operating procedures are outlined in the KLN 89B GPS Pilot's Guide, P/N 006-08786-0000, dated May 1995, (or later applicable revision). A KLN 89B Quick Reference, P/N 006-08787-0000 dated 5/ 95 (or later applicable revision) containing an approach sequence, operating bps and approach related messages is intended for cockpit use by the KLN 89B familiar pilot when conducting instrument approaches.

**B. SYSTEM ANNUNCIATORS/SWITCHES/CONTROLS**

- 1. HSI NAV presentation (NAV/GPS) switch annunciator- May be used to select data for presentation on the pilot's HSI; either NAV data from the number one navigation receiver or GPS data from the KLN 89B GPS. Presentation on the HSI is also required for autopilot coupling. NAV is green. GPS is blue.

**NORMAL PROCEDURES**

2. Message (MSG) annunciator - Will flash to alert the pilot of a situation that requires attention. Press the MSG button on the KLN 89B GPS to view the message. (Appendix B of the KLN 89B Pilot's Guide contains a list of all of the message page messages and their meanings). MSG is amber.
3. Waypoint (WPT) annunciator - Prior to reaching a waypoint in the active flight plan, the KLN 89B GPS will provide navigation along a curved path segment to ensure a smooth transition between two adjacent legs in the flight plan. This feature is called turn anticipation. Approximately 20 seconds prior to the beginning of turn anticipation the WPT annunciator will flash, going solid upon initialization of the turn, and extinguishing upon turn completion. WPT is amber.

**WARNING**

Turn anticipation is automatically disabled for FAF waypoints and those used exclusively in SID/STARS where overflight is required. For waypoints shared between SID/STARS and published en route segments (requiring overflight in the SID/ STARS), proper selection on the presented waypoint page is necessary to provide adequate route protection on the SID/STARS.

4. HSI course control ① knob - Provides analog course input to the KLN 89B in OBS when the NAV/GPS switch/annunciator is in GPS. When the NAV/GPS switch annunciation is in NAV, GPS course selection in OBS mode is digital through the use of the controls and display at the KLN 89B. The HSI course control knob must also be set to provide proper course datum to the autopilot if coupled to the KLN 89B in LEG or OBS.

**NOTE**

Manual HSI course centering in OBS using the control knob can be difficult, especially at long distances. Centering the dbar can best be accomplished by pressing  and then manually setting the HSI pointer to the course value prescribed in the KLN 89B displayed message.

**ISSUED: JULY 12, 1995**  
**REVISED: DECEMBER 11, 1995**

**REPORT: VB-1612**  
**5 of 12 9-17**

NORMAL PROCEDURES

5. GPS approach (GPS APR ARM/ACTV) switch/annunciator - Used to (a) manually select or deselect approach ARM (or deselect approach ACTV) and (b) annunciate the stage of approach operation either armed (ARM) or activated (ACTV). Sequential button pushes if in ACTV would first result in approach ARM and then approach arm canceled. Subsequent button pushes will cycle between the armed state (if an approach is in the flight plan) and approach arm canceled. Approach ACTV cannot be selected manually. GPS APR and ARM are white. ACTV is green.
6. RMI NAV presentation switch - May be used to select data for presentation on the RMI; either NAV 1 data from the number one navigation receiver, NAV 2 data from the number two navigation receiver or GPS data from the KLN 89B GPS.

C. PILOTS DISPLAY

Left/right steering information is presented on the pilot's HSI as a function of the NAV/GPS switch position.

D. AUTOPILOT COUPLED OPERATION

The KLN 89B may be coupled to the autopilot by first selecting GPS on the NAV/GPS switch. Manual selection of the desired track on the pilot's HSI course pointer is required to provide course datum to the autopilot. (Frequent manual course pointer changes may be necessary, such as in the case of flying a DME arc.) The autopilot approach mode (APR) should be used when conducting a coupled GPS approach.

NOTE

Select HDG mode for DME arc intercepts. NAV or APR coupled DME arc intercepts can result in excessive overshoots (aggravated by high ground speeds and/or intercepts from inside the arc).



**NORMAL PROCEDURES**

**E. ALTITUDE ALERT AURAL TONES**

- 1000 feet prior to reaching the selected altitude - three short tones.
- Upon reaching the selected altitude - two short tones.
- Deviating above or below the selected altitude by more than the warn altitude - four short tones.

**F. APPROACH MODE SEQUENCING AND RAIM PREDICTION**

**NOTE**

The special use airspace alert will automatically be disabled prior to flying an instrument approach to reduce the potential for message congestion.

1. Prior to arrival, select a STAR if appropriate from the **APT 7** page. Select an approach and an initial approach fix (IAF) from the **APT 8** page.

**NOTES**

- Using the outer knob, select the **ACT** (Active Flight Plan Waypoints) pages. Pull the inner knob out and scroll to the destination airport, then push the inner knob in and select the **ACT 7** or **ACT 8** page.
  - To delete or replace a **SID**, **STAR** or approach, select **FPL 0** page. Place the cursor over the name of the procedure, press **ENT** to change it, or **CLR** then **ENT** to delete it.
2. En route, check for **RAIM** availability at the destination airport **ETA** on the **OTH 3** page.

**NOTE**

**RAIM** must be available at the **FAF** in order to fly an instrument approach. Be prepared to terminate the approach upon loss of **RAIM**.

NORMAL PROCEDURES

3. At 30 nm from the airport:
  - a. Verify automatic annunciation of APR ARM.
  - b. Note automatic dbar scaling change from  $\pm 5.0$  nm to  $\pm 1.0$  nm over the next 30 seconds.
  - c. Update the KLN 89B altimeter baro setting as required.
  - d. Internally the KLN 89B will transition from en route to terminal integrity monitoring.
4. Select NAV 4 page to fly the approach procedure.
  - a. If receiving radar vectors, or need to fly a procedure turn or holding pattern, fly in OBS until inbound to the FAF.

NOTE

OBS navigation is TO-FROM (like a VOR) without waypoint sequencing.

- b. NoPT routes including DME arc's are flown in LEG. LEG is mandatory from the FAF to the MAP.

NOTE

Select HDG mode for DME arc intercepts. NAV or APR coupled DME arc intercepts can result in excessive overshoots (aggravated by high ground speeds and/or intercepts from inside the arc).

WARNING

Flying final outbound from an off airport vortac on an overlay approach; beware of the DME distance increasing on final approach, and the GPS distance-to waypoint decreasing, and not matching the numbers on the approach plate!

5. At or before 2 nm from the FAF inbound:
  - a. Select the FAF as the active waypoint, if not accomplished already.
  - b. Select LEG operation.

## NORMAL PROCEDURES

6. Approaching the FAF inbound (within 2 nm.):
  - a. Verify APR ACTV.
  - b. Note automatic dbar scaling change from  $\pm 1.0$  nm to  $\pm 0.3$  nm over the 2 nm inbound to the FAF.
  - c. Internally the KLN 89B will transition from terminal to approach integrity monitoring.
7. Crossing the FAF and APR ACTV is not annunciated:
  - a. Do not descend.
  - b. Execute the missed approach.
8. Missed Approach:
  - a. Climb
  - b. Navigate to the MAP (in APR ARM if APR ACTV is not available).

## NOTE

There is no automatic LEG sequencing at the MAP.

c. After climbing in accordance with the published missed approach procedure, press  verify or change the desired holding fix and press ENT.

## GENERAL NOTES

- The data base must be up to date for instrument approach operation.
- Only one approach can be in the flight plan at a time.
- If the destination airport is the active waypoint at the time of the instrument approach selection, the active waypoint will shift automatically to the chosen IAF.
- Checking RAIM prediction for your approach while en route using the OTH 3 page is recommended. A self check occurs automatically within 2 nm of the FAF. APR ACTV is inhibited without RAIM.
- Data cannot be altered, added to or deleted from the approach procedures contained in the data base. (DME arc intercepts may be relocated along the arc through the NAV4 or the FPL 0 pages).
- Some approach waypoints do not appear on the approach plates (including in some instances the FAF)!

**NORMAL PROCEDURES**

- **Waypoint suffixes in the flight plan:**
  - i - IAF**
  - f- FAF**
  - m - MAP**
  - h missed approach holding fix.**
- **The DME arc IAF (arc intercept waypoint) will be a) on your present position radial off the arc VOR when you load the IAF into the flight plan, or b) the beginning of the arc if currently on a radial beyond the arc limit. To adjust the arc intercept to be compatible with a current radar vector, bring up the arc IAF waypoint in the NAV 4 page scanning field or under the cursor on the FPL 0 page, press CLR, then ENT. Fly the arc in LEG. adjust the HSI or CDI course pointer with reference to the desired track value on the NAV 4 page (it will flash to remind you). Left/right dbar information is relative to the arc. Displayed distance is not along the arc but direct to the active waypoint. (The ARC radial is also displayed in the lower right corner of the NAV 4 page.)**
- **The DME arc IAF identifier may be unfamiliar. Example: D098G where 098 stands for the 098° radial off the referenced VOR, and G is the seventh letter in the alphabet indicating a 7 DME arc.**

## NORMAL PROCEDURES

- APR ARM to APR ACTV is automatic provided:
  - a. You are in APR ARM (normally automatic).
  - b. You are in LEG mode!
  - c. The FAF is the active waypoint!
  - d. Within 2 n.m. of the FAF.
  - e. Outside of the FAF.
  - f. Inbound to the FAF.
  - g. RAIM is available.
- Direct-To operation between the FAF and MAP cancels APR ACTV. Fly the missed approach in APR ARM.
- Flagged navigation inside the FAF may usually be restored (not guaranteed) by pressing the GPS APR button changing from ACTV to ARM. Fly the missed approach.
- The instrument approach using the KLN 89B may be essentially automatic starting 30 nm out (with a manual baro setting update) or it may require judicious selection of the OBS and LEG modes.
- APR ARM may be canceled at any Time by pressing the GPS APR button. (A subsequent press will reselect it.)

## SECTION 5- PERFORMANCE

No change.

## SECTION 6- WEIGHT AND BALANCE

Factory installed optional equipment is included in the licensed weight and balance data in Section 6 of the Basic Pilot's Operating Handbook.

ISSUED: JULY 12, 1995  
REVISED: DECEMBER 11, 1995

REPORT: VB-1612  
11 of 12 9-23

**THIS PAGE INTENTIONALLY LEFT BLANK**

PILOT'S OPERATING HANDBOOK  
AND  
FAA APPROVED AIRPLANE FLIGHT MANUAL

SUPPLEMENT NO. 5  
FOR  
BENDIX/KING KX 155A  
COMM/NAV SYSTEM

This supplement must be attached to the Pilot's Operating Handbook and FAA Approved Airplane Flight Manual when the KX 155A Comm/Nav System is installed per the Piper Drawings. The information contained herein supplements or supersedes the Pilot's Operating Handbook and FAA Approved Airplane Flight Manual only in those areas listed herein. For limitations, procedures and performance information not contained in this supplement, consult the Pilot's Operating Handbook and FAA Approved Airplane Flight Manual.

FAA APPROVED:

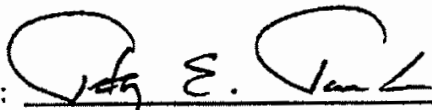

PETER E. PECK  
D.O.A. NO. SO-1  
THE NEW PIPER AIRCRAFT, INC.  
VERO BEACH, FLORIDA

DATE OF APPROVAL: November 16, 1998

ISSUED: JULY 12, 1995  
REVISED: NOVEMBER 16, 1998

REPORT: VB-1612  
1 of 12. 9-25

**SECTION 1 GENERAL**

This supplement supplies information necessary for the operation of the airplane when the Bendix/King KX 155A Comm/Nav System is installed in accordance with FAA approved Piper data.

**SECTION 2 LIMITATIONS**

No change.

**SECTION 3- EMERGENCY PROCEDURES**

No change.

**SECTION 4- NORMAL PROCEDURES**

**COMM TRANSCEIVER**

- (a.) Rotate the volume (VOL) knob clockwise from the OFF position.
- (b.) Pull the VOL knob out and adjust for desired listening level.
- (c.) Push the VOL knob back in to actuate the automatic squelch.
- (d.) Select the desired operating frequency in the standby display by rotating the frequency select knobs either clockwise or counter-clockwise.
- (e.) Push the comm transfer button to transfer the frequency from the standby to the active display.

**NAV RECEIVER**

- (a.) The right portion of the display is allocated to NAV receiver information. The frequency channeling is similar to the Comm when operating in the frequency mode. The NAV increment/decrement knobs are located on the right hand side of the front panel.

**SECTION 5- PERFORMANCE**

No change.

**SECTION 6- WEIGHT AND BALANCE**

See Section 6 of the basic Pilots Operating Handbook.



## SECTION 7 DESCRIPTION &amp; OPERATION

## GENERAL

All controls required to operate the KX 155A/165A are located on the unit front panel. (See Figure 3-1.)

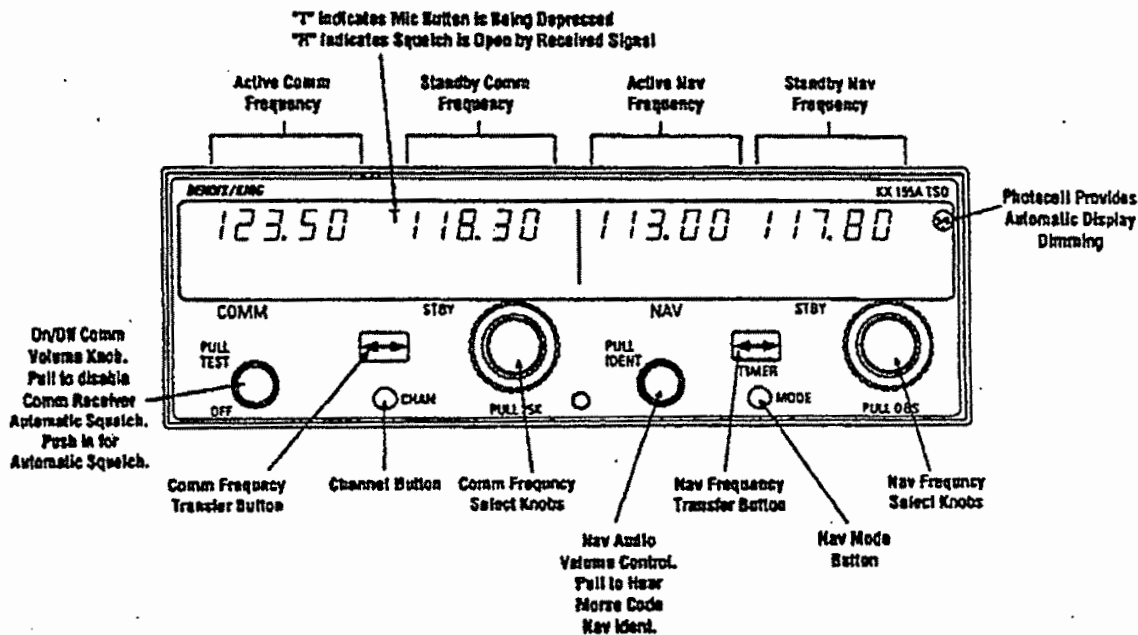

FIGURE 3-1  
KX 155A CONTROL FUNCTIONS

## COMM TRANSCEIVER

Rotate the VOL knob clockwise from the OFF position. Pull the VOL knob out and adjust for desired listening level. Push the VOL knob back in to actuate the automatic squelch.

The left portion of the digital display readout is allocated for COMM ACTIVE, and COMM STANDBY frequencies with a "T" between them to indicate TRANSMIT and an "R" to indicate RECEIVE modes of operation.

Select the desired operating frequency in the standby display by rotating the Frequency Select Knobs either clockwise or counter-clockwise. A clockwise rotation will increment the previous frequency while a counterclockwise rotation will decrement the previous frequency.

**COMM TRANSCEIVER (CONTD)**

The outer knob will change the MHz portion of the standby display. At one band-edge (118 or 136 MHz) the following 1 MHz change will wrap around to the other band-edge. The inner knob will change the kHz portion of the standby display. It will change in steps of 50 kHz when the knob is pushed in, and 25 kHz when the knob is pulled out. For 8.33 kHz versions, channels are incremented in 25 kHz steps with the knob pushed in and 8.33 kHz with the knob pulled out. (Both 8.33 kHz and 25 kHz frequencies are channeled when the knob is pulled out). The frequency wrap around at the edge of the band is also utilized when incrementing or decrementing the kHz portion of the standby display.

To tune the radio to the desired operating frequency, the desired frequency must be entered into the standby display and then the transfer button must be pushed. This will trade the contents of the active and standby displays. The operating frequency can also be entered by accessing the ACTIVE ENTRY (direct tune) mode which is done by pushing and holding the COMM TRANSFER button for 2 or more seconds. In the direct tune mode, only the active part of the display is visible. The desired frequency can be directly entered into the display. Push the COMM TRANSFER button again to return to the active/standby display.

The transceiver is always tuned to the frequency appearing in the ACTIVE display. It is therefore possible to have two different frequencies stored in the ACTIVE and STANDBY displays and to change back and forth between them at the simple push of the transfer button.

During the transmit mode of operation, a "T" will appear between the ACTIVE and STANDBY displays. An "R" will appear between the ACTIVE and STANDBY displays if a detected signal is strong enough to open the squelch, signifying that the transceiver is in the receive mode of operation.

A non-volatile memory stores the comm ACTIVE and STANDBY frequencies on power down. When the unit is turned on again, the COMM ACTIVE and STANDBY windows will display the same ACTIVE and STANDBY frequencies that were displayed before power down.

The KX 155A also has provision to program 32 channels. Pressing the CHAN button for 2 or more seconds will cause the unit to enter the channel program mode. Upon entering the channel program mode, "PG" is displayed next to the channel number and the channel number will flash indicating that it can be programmed. The desired channel can be selected by turning the comm kHz knob. The channel frequency can be entered by pushing the COMM TRANSFER button which will cause the standby frequency to flash. The comm frequency knobs are then used to enter the desired frequency. If dashes (displayed when rotating the outer knob between 136 MHz and 118 MHz) are entered instead of a frequency, the corresponding channel is skipped in channel selection mode. Additional channels may be programmed by pressing the COMM TRANSFER and using the same procedure. To exit the program mode and save the channel information, momentarily push the CHAN button. This will cause the unit to return to the previous frequency entry mode. The unit will also exit the channel program mode if there is no button or knob activity for 20 seconds.

The channel selection mode can then be entered by momentarily pushing CHAN button. "CH" is displayed next to the last used channel number. The comm frequency knobs can be used to select the desired channel. The unit will automatically default to the previous mode if no channel is selected within 2 seconds after entering the channel selection mode.

The unit is placed in the transmit mode by depressing the MIC KEY button. The unit has a stuck microphone alert feature. If the microphone is keyed continuously for greater than 33 seconds, the transmitter stops transmitting and the active Comm frequency flashes to alert the pilot of the stuck microphone condition.

## NAV RECEIVER

The right portion of the display is allocated to NAV receiver information. The frequency channeling is similar to the COMM when operating in the frequency mode (Figure 3-1). The NAV increment/decrement knobs are located on the right hand side of the front panel. The outer knob operates in 1 MHz steps and increments/decrements the STANDBY frequency display.

NAV RECEIVER (CONT'D)

The inner knob operates in 50 kHz steps. The NAV receiver's lower and upper frequency limits are 108.00 MHz and 117.95 MHz. Exceeding the upper limit of frequency band will automatically return to the lower limit and vice versa.

Depressing the NAV frequency transfer button for 2 seconds or more will cause the display to go in to the ACTIVE ENTRY mode. Only the ACTIVE frequency will be displayed and it can be directly changed by using the NAV inc/dec knobs. The display will return to the ACTIVE/STANDBY mode when the NAV frequency transfer button is pushed.

Depressing the mode button will cause the NAV display to go from the ACTIVE/STANDBY format to the ACTIVE/CDI (Course Deviation Indicator) format as shown below in Figure 3-2. In the CDI mode, the increment/decrement knob (pushed in) channels the ACTIVE frequency window and depressing the frequency transfer button will cause the ACTIVE frequency to be placed in blind storage and the STANDBY frequency (in blind storage) to be displayed in the ACTIVE window display. When the ACTIVE window is tuned to a VOR frequency, the standby frequency area is replaced by a three digit OBS (Omni Bearing Selector) display. The desired OBS course can be selected by pulling out the inner NAV frequency knob and turning it. This OBS display is independent of any OBS course selected on an external CDI or HSI. An "OBS" in the middle of the NAV display will flash while the inner NAV frequency knob is pulled out. The CDI is displayed on the line below the frequency/OBS. When the ACTIVE window is tuned to a localizer frequency, the standby frequency area is replaced by "LOC" Figure 3-3. Illustrations of the display are shown on the next page.

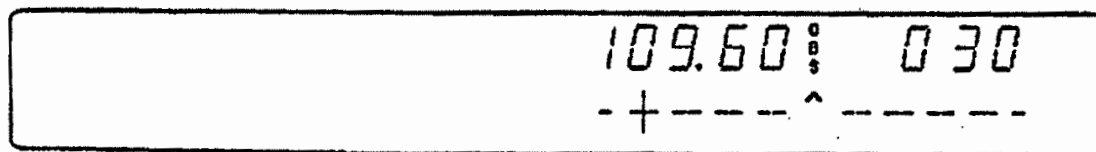

**FIGURE 3-2**  
**NAV DISPLAY; ACTIVE VOR FREQUENCY/CDI FORMAT**

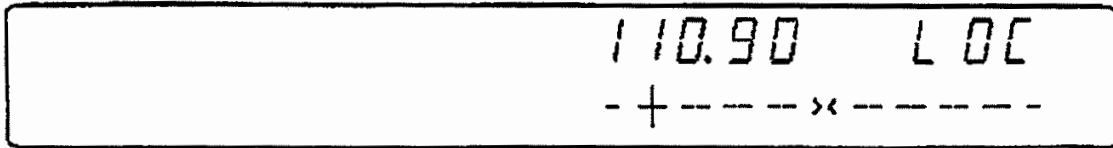

FIGURE 3-3

NAV DISPLAY; ACTIVE LOCALIZER FREQUENCY/CDI FORMAT

When the received signal is too weak to ensure accuracy the display will “flag”. See Figure 3-4.

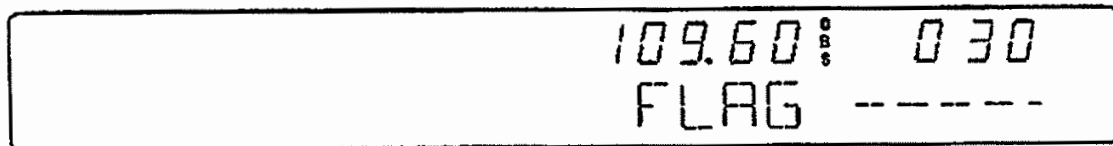
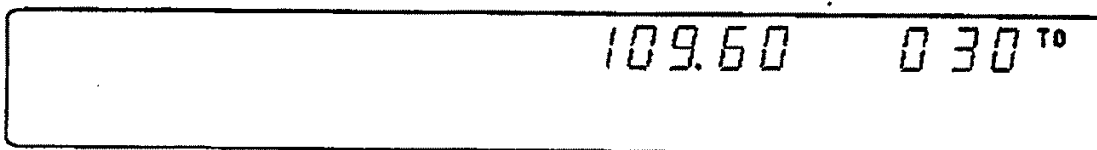

FIGURE 3-4 VOR FLAG DISPLAY

NAV RECEIVER (CONT'D)

Depressing the mode button will cause the NAV display to go from the ACTIVE/CDI format to the ACTIVE/BEARING format. In the BEARING mode, the increment/decrement knob channels the ACTIVE frequency window and depressing the frequency transfer button will cause the ACTIVE frequency to be placed in blind storage and the STANDBY frequency (in blind storage) to be displayed in the ACTIVE window display. In bearing mode of operation, the right hand window of NAV display shows the bearing TO the station. Figure 3-5 below illustrates the NAV side of the display in this mode:



**FIGURE 3-5 VOR MODE; BEARING TO FUNCTION**

When a too weak or invalid VOR signal is received the display flags as shown in Figure 3-6.

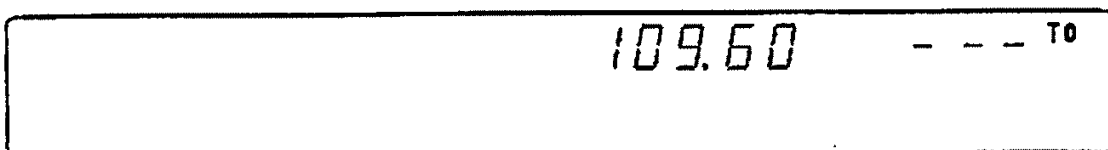

**FIGURE 3-6 VOR MODE; ACTIVE/BEARING, FLAG DISPLAY**

Another push of the mode button will cause the NAV display to go from the ACTIVE/BEARING format to the ACTIVE/RADIAL format as shown in Figure 3-7. In the RADIAL mode, the increment/decrement knob channels the ACTIVE frequency window and depressing the frequency transfer button will cause the ACTIVE frequency to be placed in blind storage and the STANDBY frequency (in blind storage) to be displayed in the ACTIVE window display. In radial mode of operation, the right hand window of NAV display shows the radial FROM the station. The picture below illustrates the NAV side of the display in this mode:

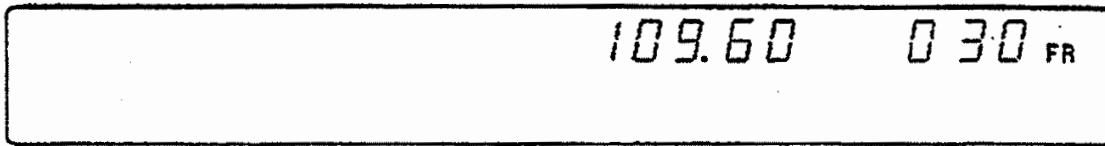

FIGURE 3-7 VOR MODE; RADIAL FROM FUNCTION

When a too weak or invalid VOR signal is received the display flags as shown in Figure 3-8.

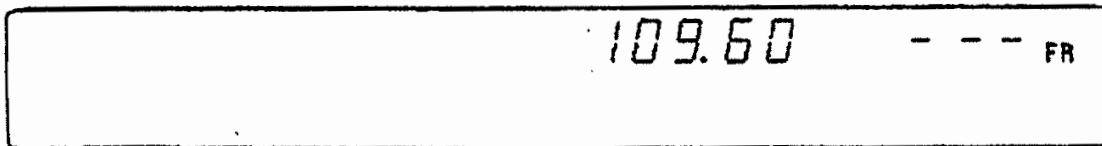

FIGURE 3-8 VOR MODE; ACTIVE/RADIAL, FLAG DISPLAY

NAV RECEIVER (CONT'D)

Another push of the mode button will cause the unit to go into the TIMER mode. See Figure 3-9. When the unit is turned on the elapsed timer begins counting upwards from zero. The timer can be stopped and reset to zero by pushing the NAV frequency transfer button for 2 seconds or more causing the ET on the display to flash. In this state the timer can be set as a countdown timer or the elapsed timer can be restarted. The countdown timer is set by using the NAV inc/dec knobs to set the desired time and then pushing the NAV frequency transfer button to start the timer. The outer knob selects minutes, the inner knob in the "in ~ position selects ten second intervals, and the inner knob in the ~out" position selects individual seconds. After the countdown timer reaches zero, the counter will begin to count upwards indefinitely while flashing for the first 15 seconds. The elapsed timer can also be reset to zero and started again after it has been stopped and reset to zero by pushing the NAV frequency transfer button.

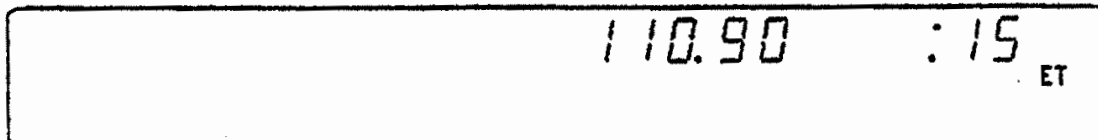

FIGURE 3-9 TIMER MODE

The NAV ACTIVE and STANDBY frequencies are stored in the memory on power down and return on power up.

When the smaller increment/decrement knob is pushed in, depressing the NAV TRANSFER button will interchange the ACTIVE and STANDBY frequencies. The NAV IDENT knob is active in the pulled out position so that both voice and ident can be heard. When this knob is pushed in, the ident tone is attenuated. The volume of voice/ident can be adjusted by turning this knob.



**PILOT CONFIGURATION**

This mode can be accessed by pressing and holding the Nav Mode Button for more than 2 seconds and then pressing the Nav Frequency Transfer Button for an additional 2 seconds, while continuing to hold the Nav Mode Button. When the Pilot Config Mode is entered the unit will show the "SWRV" mnemonic which is the unit software revision level. Adjustment pages can be accessed by MODE button presses.

The pilot may adjust two parameters in the pilot configuration, the display minimum brightness and sidetone volume level. See Table 3-1.

Minimum Brightness (BRIM) will have a range of 0 - 255. The dimmest is 0 and the brightest is 255.

Sidetone volume level is adjusted when SIDE is displayed. Values from 0 - 255 may be selected with 0 being least volume, 255 being the greatest.

| Adjustment                 | Mnemonic | Min Level | Max Level |
|----------------------------|----------|-----------|-----------|
| Software Revision Number   | SWRV     | --        | --        |
| Minimum Display Brightness | BRIM     | 0         | 255       |
| Sidetone Level             | SIDE     | 0         | 255       |

**Table 3-1 Pilot Configuration**

Subsequent presses of the MODE button sequences through SWRV, BRIM, SIDE, and then back to SWRV.

Momentarily pressing the Nav Transfer Button exits Pilot configuration mode. The Nav returns to its pre-Pilot Config state with the new brightness and sidetone levels stored in non-volatile memory.

**THIS PAGE INTENTIONALLY LEFT BLANK**

**PILOT'S OPERATING HANDBOOK  
AND  
FAA APPROVED AIRPLANE FLIGHT MANUAL**

**SUPPLEMENT NO. 6  
FOR  
S-TEC MANUAL ELECTRIC TRIM SYSTEM  
WITH TRIM MONITOR  
(Serial numbers 2844010 and up)**

The FAA approved operational supplement for the S-TEC Manual Electric Trim System, installed in accordance with STC SA7805SW-D, is required for operation of this system. S-TEC will be responsible to supply and revise the operational supplement. It is permitted to include the S-TEC supplement in this location of the Pilot's Operating Handbook unless otherwise stated by S-TEC. The information contained in the S-TEC supplement may supersede or supplement the information in the basic Pilot's Operating Handbook and FAA Approved Airplane Flight Manual with respect to the operation of the S-TEC Manual Electric Trim System. For limitations, procedures and performance information not contained in the S-TEC supplement, consult the basic Pilot's Operating Handbook and FAA Approved Airplane Flight Manual.

**ISSUED: JULY 12, 1995  
REVISED: JANUARY 31, 2000**

**REPORT: VB-1612  
9-37**

**THIS PAGE INTENTIONALLY LEFT BLANK**

**PILOT'S OPERATING HANDBOOK  
AND  
FAA APPROVED AIRPLANE FLIGHT MANUAL**

**SUPPLEMENT NO. 7  
FOR  
GARMIN GNS 430 VHF COMMUNICATION  
TRANSCEIVER/VOR/ILS RECEIVER/GPS RECEIVER**

This supplement must be attached to the Pilot's Operating Handbook and FAA Approved Airplane Flight Manual when the Garmin GNS 430 VHF Communication Transceiver/VOR/ILS Receiver/Global Positioning System is installed per the Equipment List. The information contained herein supplements or supersedes the Pilot's Operating Handbook and FAA Approved Airplane Flight Manual only in those areas listed herein. For limitations, procedures and performance information not contained in this supplement, consult the Pilot's Operating Handbook and FAA Approved Airplane Flight Manual.

FAA APPROVED:

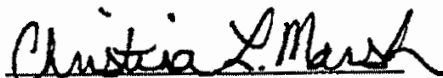

CHRISTINA L. MARSH

D.O.A. NO. SO-1

THE NEW PIPER AIRCRAFT, INC.

VERO BEACH, FLORIDA

DATE OF APPROVAL: SEPTEMBER 14, 2000ISSUED: JULY 12, 1995  
REVISED: SEPTEMBER 14, 2000REPORT: VB-1612  
1 of 8, 9-39

**SECTION 1 - GENERAL**

The GNS 430 System is a fully integrated, panel mounted instrument, which contains a VHF Communications Transceiver, a VOR/ILS receiver, and a Global Positioning System (GPS) Navigation computer. The system consists of a GPS antenna, GPS receiver, VHF VOR/LOC/GS antenna, VOR/ILS receiver, VHF COMM antenna and a VHF Communications transceiver. The primary function of the VHF Communication portion of the equipment is to facilitate communication with Air Traffic Control. The primary function of the VOR/ILS Receiver portion of the equipment is to receive and demodulate VOR, Localizer, and Glide Slope signals. The primary function of the GPS portion of the system is to acquire signals from the GPS system satellites, recover orbital data, make range and Doppler measurements, and process this information in real-time to obtain the user's position, velocity, and time.

Provided the GARMIN GNS 430's GPS receiver is receiving adequate usable signals, it has been demonstrated capable of and has been shown to meet the accuracy specifications for:

VFR/IFR enroute, terminal, and non-precision instrument approach (GPS, Loran-C, VOR, VOR-DME, TACAN, NDB, NDB-DME, RNAV) operation within the U.S. National Airspace System in accordance with AC 20-138.

North Atlantic Minimum Navigation Performance Specification (MNPS) Airspace in accordance with AC 91-49 and AC 120-33.

The system meets RNP5 airspace (BRNAV) requirements of AC 90-96 and in accordance with AC 20-138, and JAA AMJ 20X2 Leaflet 2 Revision 1, provided it is receiving usable navigation information from the GPS receiver.

Navigation is accomplished using the WGS-84 (NAD-83) coordinate reference datum. Navigation data is based upon use of only the Global Positioning System (GPS) operated by the United States of America.

**SECTION 2 - LIMITATIONS**

- A. The GARMIN GNS 430 Pilot's Guide, p/n 190-00140-00, Rev. A, dated October 1998, or later appropriate revision, must be immediately available to the flight crew whenever navigation is predicated on the use of the system.
- B. The GNS 430 must utilize the following or later FAA approved software versions:

| Sub-System | Software Version |
|------------|------------------|
| Main       | 2.00             |
| GPS        | 2.00             |
| COMM       | 2.00             |
| VOR/LOC    | 2.00             |
| G/S        | 2.00             |

The main software version is displayed on the GNS 430 self test page immediately after turn-on for 5 seconds. The remaining system software versions can be verified on the AUX group sub-page 2, "SOFTWARE/DATABASE VER".

- C. IFR enroute and terminal navigation predicated upon the GNS 430's GPS Receiver is prohibited unless the pilot verifies the currency of the data base or verifies each selected waypoint for accuracy by reference to current approved data.
- D. Instrument approach navigation predicated upon the GNS 430's GPS Receiver must be accomplished in accordance with approved instrument approach procedures that are retrieved from the GPS equipment data base. The GPS equipment data base must incorporate the current update cycle.
  - 1. Instrument approaches utilizing the GPS receiver must be conducted in the approach mode and Receiver Autonomous Integrity Monitoring (RAIM) must be available at the Final Approach Fix.

## SECTION 2 - LIMITATIONS (continued)

2. Accomplishment of ILS, LOC, LOC-BC, LDA, SDF, MLS or any other type of approach not approved for GPS overlay with the GNS 430's GPS receiver is not authorized.
  3. Use of the GNS 430 VOR/ILS receiver to fly approaches not approved for GPS require VOR/ILS navigation data to be present on the external indicator.
  4. When an alternate airport is required by the applicable operating rules, it must be served by an approach based on other than GPS or Loran-C navigation, the aircraft must have the operational equipment capable of using that navigation aid, and the required navigation aid must be operational.
  5. VNAV information may be utilized for advisory information only. Use of VNAV information for Instrument Approach Procedures does not guarantee Step-Down Fix altitude protection, or arrival at approach minimums in normal position to land.
- E. If not previously defined, the following default settings must be made in the "SETUP 1" menu of the GNS 430 prior to operation (refer to Pilot's Guide for procedure if necessary):
1. dis, spd.....  $\frac{n}{m}$   $k_t$  (sets navigation units to "nautical miles" and "knots")
  2. alt, vs.....  $f_t$  fpm (sets altitude units to "feet" and "feet per minute")
  3. map datum..WGS 84 (sets map datum to WGS-84, see not below)
  4. posn.....deg-min (sets navigation grid units to decimal minutes)

## NOTE

In some areas outside the United States, datums other than WGS-84 or NAD-83 may be used. If the GNS 430 is authorized for use by the appropriate Airworthiness authority, the required geodetic datum must be set in the GNS 430 prior to its use for navigation.



**SECTION 3 - EMERGENCY PROCEDURES****ABNORMAL PROCEDURES**

- A. If GARMIN GNS 430 navigation information is not available or invalid, utilize remaining operational navigation equipment as required.
- B. If "RAIM POSITION WARNING" message is displayed the system will flag and no longer provide GPS based navigational guidance. The crew should revert to the GNS 430 VOR/ILS receiver or an alternate means of navigation other than the GNS 430's GPS receiver.
- C. If "RAIM IS NOT AVAILABLE" message is displayed in the enroute, terminal, or initial approach phase of flight, continue to navigate using the GPS equipment or revert to an alternate means of navigation other than the GNS 430's GPS receiver appropriate to the route and phase of flight. When continuing to use GPS navigation, position must be verified every 15 minutes using the GNS 430's VOR/ILS receiver or another IFR-approved navigation system.
- D. If "RAIM IS NOT AVAILABLE" message is displayed while on the final approach segment, GPS based navigation will continue for up to 5 minutes with approach CDI sensitivity (0.3 nautical mile). After 5 minutes the system will flag and no longer provide course guidance with approach sensitivity. Missed approach course guidance may still be available with 1 nautical mile CDI sensitivity by executing the missed approach.
- E. In an in-flight emergency, depressing and holding the Comm transfer button for 2 seconds will select the emergency frequency of 121.500 Mhz into the "Active" frequency window.

## SECTION 4 - NORMAL PROCEDURES

### WARNING

Familiarity with the enroute operation of the GNS 430 does not constitute proficiency in approach operations. Do not attempt approach operations in IMC prior to attaining proficiency in the use of the GNS 430 approach feature.

#### A. DETAILED OPERATING PROCEDURES

Normal operating procedures are described in the GARMIN GNS 430 Pilot's Guide, p/n 190-00140-00, Rev. A, dated October 1998, or later appropriate revision.

#### B. PILOT'S DISPLAY

The GNS 430 System data will appear on the Pilot's HSI. The source of data is either GPS or VLOC as annunciated on the display above the CDI key.

#### C. AUTOPILOT/FLIGHT DIRECTOR OPERATION

Coupling of the GNS 430 System steering information to the autopilot/flight director can be accomplished by engaging the autopilot/flight director in the NAV or APR mode.

When the autopilot/flight director system is using course information supplied by the GNS 430 System and the course pointer is not automatically driven to the desired track, the course pointer on the HSI must be manually set to the desired track (DTK) indicated by the GNS 430. For detailed autopilot/flight director operational instructions, refer to the FAA Approved Flight Manual Supplement for the autopilot/flight director.

**SECTION 4 - NORMAL PROCEDURES (continued)****D. AUTOMATIC LOCALIZER COURSE CAPTURE**

By default, the GNS 430 automatic localizer course capture feature is enabled. This feature provides a method for system navigation data present on the external indicators to be switched automatically from GPS guidance to localizer / glide slope guidance at the point of course intercept on a localizer at which GPS derived course deviation equals localizer derived course deviation. If an offset from the final approach course is being flown, it is possible that the automatic switch from GPS course guidance to localizer / glide slope course guidance will not occur. It is the pilot's responsibility to ensure correct system navigation data is present on the external indicator before continuing a localizer based approach beyond the final approach fix.

**SECTION 5 - PERFORMANCE**

No change.

**SECTION 6 - WEIGHT AND BALANCE**

Factory installed optional equipment is included in the licensed weight and balance data in Section 6 of the basic Pilot's Operating Handbook.

**SECTION 7 - DESCRIPTION AND OPERATION**

See GNS 430 Pilot's Guide for a complete description of the GNS 430 system.

**ISSUED: JULY 12, 1995**  
**REVISED: SEPTEMBER 14, 2000**

**REPORT: VB-1612**  
**7 of 8, 9-45**

**THIS PAGE INTENTIONALLY LEFT BLANK**

**PILOT'S OPERATING HANDBOOK  
AND  
FAA APPROVED AIRPLANE FLIGHT MANUAL  
  
SUPPLEMENT NO. 8  
FOR  
GARMIN GTX 327 TRANSPONDER**

This supplement must be attached to the Pilot's Operating Handbook and FAA Approved Airplane Flight Manual when the Garmin GTX 327 Transponder is installed per the Equipment List. The information contained herein supplements or supersedes the Pilot's Operating Handbook and FAA Approved Airplane Flight Manual only in those areas listed herein. For limitations, procedures and performance information not contained in this supplement, consult the Pilot's Operating Handbook and FAA Approved Airplane Flight Manual.

FAA APPROVED: Christina L. Marsh  
CHRISTINA L. MARSH  
D.O.A. NO. SO- 1  
THE NEW PIPER AIRCRAFT, INC.  
VERO BEACH, FLORIDA

DATE OF APPROVAL: September 14, 2000

ISSUED: JULY 12, 1995  
REVISED: SEPTEMBER 14, 2000

REPORT: VB-1612  
1 of 10, 9-47

**SECTION 1 - GENERAL**

This supplement supplies information necessary for the operation of the airplane when the Garmin GTX 327 Transponder is installed in accordance with FAA approved Piper data.

**SECTION 2 - LIMITATIONS**

No change.

**SECTION 3 - EMERGENCY PROCEDURES**

To transmit an emergency signal:

- Mode Selection Key - ALT
- Code Selection - SELECT 7700

To transmit a signal representing loss of all communications:

- Mode Selection Key - ALT
- Code Selection - SELECT 7600

**SECTION 4 - NORMAL PROCEDURES**

**BEFORE TAKEOFF:**

- To transmit Mode C (Altitude Reporting) code in flight:
- Mode Selection Key - ALT
- Code Selector Keys - SELECT assigned code.

To transmit Mode A (Aircraft Identification) code in flight:

- Mode Selector Key - ON
- Code Selector Keys - SELECT assigned code.

**NOTE**

During normal operation with the ON mode selected, the reply indicator "R" flashes, indicating transponder replies to interrogations.

**NOTE**

Mode A reply codes are transmitted in ALT also; however, Mode C codes only are suppressed when the Function Selector ON key is selected.

**SECTION 5 - PERFORMANCE**

No change.

**SECTION 6 - WEIGHT AND BALANCE**

Factory installed optional equipment is included in the licensed weight and balance data in section 6 of the Airplane Flight Manual.

**ISSUED: JULY 12, 1995**  
**REVISED: SEPTEMBER 14, 2000**

**REPORT: VB-1612**  
**3 of 10, 9-49**

## SECTION 7 - DESCRIPTION AND OPERATION

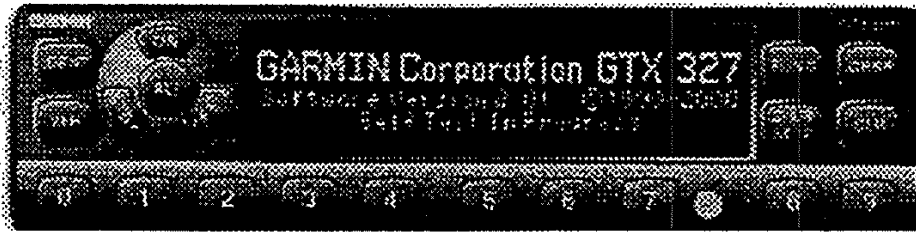

The GTX 327 transponder is powered on by pressing the **STBY**, **ALT** or **ON** keys, or by a remote avionics master switch (if applicable). After power on, a start-up page will be displayed while the unit performs a self test.

### Mode Selection Keys

**OFF** - Powers off the GTX 327.

**STBY** - Powers on the transponder in standby mode.

At power on the last active identification code will be selected. When in standby mode, the transponder will not reply to any interrogations.

**ON** - Powers on the transponder in Mode A. At power on the last active identification code will be selected. In this mode, the transponder replies to interrogations, as indicated by the Reply Symbol . Replies do not include altitude information.

**ALT** - Powers on the transponder in Mode A and Mode C. At power on the last active identification code will be selected. In ALT mode, the transponder replies to identification and altitude interrogations, as indicated by the Reply Symbol . Replies to altitude interrogations include the standard pressure altitude received from an external altitude source, which is not adjusted for barometric pressure. The ALT mode may be used in aircraft not equipped with the optional altitude encoder; however, the reply signal will not include altitude information.

### GTX 327 Configuration Mode

The GTX 327's configuration, which is normally done at time of installation, influences many of the unit's functions described in this manual. If you wish to view or change any of the GTX 327 configuration parameters, you may access the GTX 327 Configuration Mode. Use caution when changing configuration. When in doubt, contact your authorized GARMIN Aviation Service Center. The Configuration Mode should not be used while the aircraft is airborne.



## SECTION 7 - DESCRIPTION AND OPERATION (continued)

## GTX 327 Configuration Mode (continued)

## To use the GTX 327 Configuration Mode:

1. Press and hold the FUNC key while powering on the unit using the STBY, ON, or ALT key (or using an avionics master switch).
2. Press the FUNC key to sequence through the configuration pages.
3. Use the CRSR key to highlight selectable fields on each page.
4. When a field is highlighted, enter numeric data using the 0 - 9 keys, and select items from a list using the 8 or 9 keys.
5. Press the CRSR key to confirm list selections.

## Code Selection



Code selection is done with eight keys (0 - 7) that provide 4,096 active identification codes. Pushing one of these keys begins the code selection sequence. The new code will not be activated until the fourth digit is entered. Pressing the CLR key will move the cursor back to the previous digit. Pressing the CLR key when the cursor is on the first digit of the code, or pressing the CRSR key during code entry, will remove the cursor and cancel data entry, restoring the previous code. The numbers 8 and 9 are not used for code entry, only for entering a Count Down time, and in the Configuration Mode.



## SECTION 7 - DESCRIPTION AND OPERATION (continued)

### Code Selection (continued)

#### Important Codes:

- 1200 - The VFR code for any altitude in the US (Refer to ICAO standards elsewhere)
- 7000 - The VFR code commonly used in Europe (Refer to ICAO standards)
- 7500 - Hijack code (Aircraft is subject to unlawful interference)
- 7600 - Loss of communications
- 7700 - Emergency
- 7777 - Military interceptor operations (Never squawk this code)
- 0000 - Military use (Not enterable)

Care should be taken not to select the code 7500 and all codes in the 7600 - 7777 range, which trigger special indicators in automated facilities. Only the code 7500 will be decoded as the hijack code. An aircraft's transponder code (when available) is utilized to enhance the tracking capabilities of the ATC facility, therefore care should be taken when making routine code changes.

### Keys for Other GTX 327 Functions



**IDENT** - Pressing the IDENT key activates the Special Position Identification (SPI) Pulse for 18 seconds, identifying your transponder return from others on the air traffic controller's screen. The word "IDENT" will appear in the upper left corner of the display while the IDENT mode is active.



**VFR** - Sets the transponder code to the pre-programmed VFR code selected in Configuration Mode (this is set to 1200 at the factory). Pressing the VFR key again will restore the previous identification code.





**FUNC** - Changes the page shown on the right side of the display. Displayed data includes Pressure Altitude, Flight Time, Count Up timer, Count Down timer, and may include Contrast and Display Brightness, depending on configuration (as shown in the screens below):

## SECTION 7 - DESCRIPTION AND OPERATION (continued)

## Keys for Other GTX 327 Functions (continued)

 **PRESSURE ALT:** Displays the altitude data supplied to the GTX 327 in feet, hundreds of feet (i.e., flight level), or meters, depending on configuration.

 **FLIGHT TIME:** Displays the Flight Time, which is controlled by the **START/STOP** key or by a squat switch as configured during installation. With squat switch control, the timer begins when lift off is sensed and pauses when landing is sensed.

 **COUNT UP TIMER:** Controlled by **START/STOP** and **CLR** keys.

 **COUNT DOWN TIMER:** Controlled by **START/STOP**, **CLR**, and **CRSR** keys. The initial Count Down time is entered with the 0 - 9 keys.

 **CONTRAST:** This page is only displayed if manual contrast mode is selected in Configuration Mode. Contrast is controlled by the 8 and 9 keys.

 **DISPLAY:** This page is only displayed if manual backlighting mode is selected in Configuration Mode. Backlighting is controlled by the 8 and 9 keys.



**START/STOP** - Starts and stops the Count Up and Count Down timers.



**CRSR** - Initiates entry of the starting time for the Count Down timer and cancels transponder code entry.

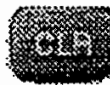

**CLR** - Resets the Count Up and Count Down timers and cancels the previous keypress during code selection.



**8** - Reduces Contrast and Display Brightness when the respective pages are displayed. Also enters the number 8 into the Count Down timer.



**9** - Increases Contrast and Display Brightness when the respective pages are displayed. Also enters the number 9 into the Count Down timer.

ISSUED: JULY 12, 1995  
REVISED: SEPTEMBER 14, 2000

REPORT: VB-1612  
7 of 10, 9-53

**SECTION 7 - DESCRIPTION AND OPERATION (continued)****Altitude Trend Indicator**

When the "PRESSURE ALT" page is displayed, an arrow may be displayed to the right of the altitude, indicating that the altitude is increasing or decreasing. One of two sizes of arrows may be displayed depending on the rate of climb/descent. The sensitivity of these arrows is set using the GTX Configuration Mode.

**Timer Operation****To operate the Flight Timer:**

1. Press the FUNC key until "FLIGHT TIME" is displayed.
2. If the GTX 327 is configured as having a squat switch installed, the timer will begin counting automatically when the squat switch senses that the aircraft has become airborne.
3. If desired, you may press **START/STOP** to pause or restart the timer.
4. Press **CLR** to reset the timer to zero.
5. If the GTX 327 is configured as having a squat switch installed, the timer will pause automatically when the squat switch senses that the aircraft has touched down.

**To operate the Count Up timer:**

1. Press the FUNC key until "COUNT UP" is displayed.
2. If necessary, press **CLR** to reset the Count Up timer to zero.
3. Press **START/STOP** to count up.
4. Press **START/STOP** again to pause the timer.
5. Press **CLR** to reset the timer to zero.

**To operate the Count Down timer:**

1. Press the FUNC key until "COUNT DOWN" is displayed.
2. Press **CRSR** and use the 0 - 9 keys to set the initial time. All digits must be entered (use the 0 key to enter leading zeros).
3. Press **START/STOP** to count down.
4. Press **START/STOP** again to pause the timer.
5. When the Count Down timer expires, the words "COUNT DOWN" are replaced with "EXPIRED", and the time begins counting up and flashing.
6. Press **CLR** to reset the timer to the initial time value.

**SECTION 7 - DESCRIPTION AND OPERATION (continued)**

**Automatic ALT/STBY Mode Switching**

If the GTX 327 is configured for automatic standby switching, the mode will automatically change to ALT when a squat switch senses that the aircraft has become airborne. Also, the mode will change to STBY automatically when a squat switch senses that the aircraft has touched down. Additionally, a delay time can be set in the Configuration Mode, causing the GTX 327 to wait a specified length of time after landing before automatically changing to STBY mode.

**ISSUED: JULY 12, 1995**  
**REVISED: SEPTEMBER 14, 2000**

**REPORT: VB-1612**  
**9 of 10, 9-55**

**THIS PAGE INTENTIONALLY LEFT BLANK**

PILOT'S OPERATING HANDBOOK  
AND  
FAA APPROVED AIRPLANE FLIGHT MANUAL  
  
SUPPLEMENT NO. 9  
FOR  
S-TEC ADF-650 SYSTEM

This supplement must be attached to the Pilot's Operating Handbook and FAA Approved Airplane Flight Manual when the S-TEC ADF-650 System is installed per the Equipment List. The information contained herein supplements or supersedes the Pilot's Operating Handbook and FAA Approved Airplane Flight Manual only in those areas listed herein. For limitations, procedures and performance information not contained in this supplement, consult the Pilot's Operating Handbook and FAA Approved Airplane Flight Manual.

FAA APPROVED: Christina L. Marsh  
CHRISTINA L. MARSH  
D.O.A. NO. SO- 1  
THE NEW PIPER AIRCRAFT, INC.  
VERO BEACH, FLORIDA

DATE OF APPROVAL: September 14, 2000

ISSUED: JULY 12, 1995  
REVISED: SEPTEMBER 14, 2000

REPORT: VB-1612  
1 of 6, 9-57

**SECTION 1 - GENERAL**

This supplement supplies information necessary for the operation of the airplane when the S-TEC ADF-650 System is installed in accordance with FAA approved Piper data.

**SECTION 2 - LIMITATIONS**

No change.

**SECTION 3 - EMERGENCY PROCEDURES**

No change.



**SECTION 4 - NORMAL PROCEDURES****To operate as an Automatic Direction Finder:**

- OFF/VOL Control - ON
- Frequency Selector Knobs - SELECT desired frequency.
- ADF SPEAKER/PHONE Selector Switch (on audio control panel) - SELECT as desired.
- OFF/VOL Control - SET to desired volume level.
- ADF Mode Control - Select ADF mode and note relative bearing on display.

**ADF Test (Pre-flight or In-flight):**

- ADF Mode Control - Select ADF mode and note relative bearing on display.
- Press the TEST button and note the pointer moves to 90° from its prior position. Excessive pointer sluggishness, wavering or reversals indicate a signal that is too weak or a system malfunction.

**To Operate BFO:**

- OFF/VOL Control - ON
- Frequency Selector Knobs - SELECT desired frequency.
- ADF SPEAKER/PHONE Selector Switch (on audio control panel) - SELECT as desired.
- ADF Mode Control - Select BFO mode.
- OFF/VOL Control - Set to desired volume level.

**SECTION 5 - PERFORMANCE**

No change.

**SECTION 6 - WEIGHT AND BALANCE**

Factory installed optional equipment is included in the licensed weight and balance data in Section 6 of the Pilot's Operating Handbook and Airplane Flight Manual.

## SECTION 7 - DESCRIPTION AND OPERATION

The S-TEC ADF-650 System operates over a frequency range of 200 through 1799 kHz in 1-kHz increments. Three operating modes are included as part of the ADF-650 System.

- BFO
- ANT
- ADF

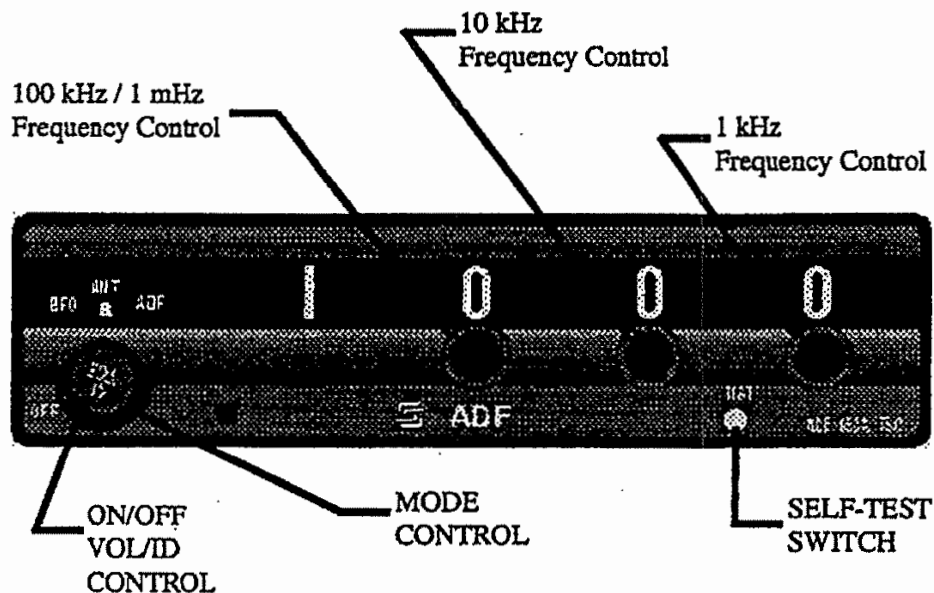

ADF-650 Receiver, Controls, and Indicators  
Figure 1

### BFO Mode

The BFO (beat frequency oscillator) and ADF (automatic direction finding) modes are navigation modes that result in pointing operation when in-range station is selected. The ADF mode is used with conventional nondirectional beacons and AM broadcast stations. The BFO mode is used to aurally identify stations that employ keyed cw rather than amplitude modulation techniques.

### NOTE

CW signals (Morse Code) are unmodulated and no audio will be heard without use of BFO. This type of signal is not used in the United States air navigation. It is used in some foreign countries and marine beacons.

**SECTION 7 - DESCRIPTION AND OPERATION (continued)**

**ANT (Antenna) Mode**

The ANT (antenna) mode cannot be used for navigation; this mode enhances audio reception clarity and is normally used for station identification.

**ADF Mode**

Automatic Direction Finder (ADF) mode is used for navigation. This mode activates the bearing pointer. The bearing pointer will point in the direction of the station relative to the aircraft heading.

**Frequency Selector Controls**

Three controls are used to select the system operating frequency. The right hand control selects 1 - kHz increments, the center control 10 - kHz increments, and the left hand control 100 - kHz increments.

**Self Test Switch**

Pressing and holding the spring loaded self test switch while in the ADF mode will cause the bearing pointer to rotate 90 degrees from its prior position if the ADF-650 system is operating properly. When the test switch is released, the bearing pointer should promptly return to its starting point. At this time, normal operation is restored.

**ON/OFF/VOL/ID Control**

This control performs three independent functions. In full ccw position, no power is applied to the system; rotating the control cw applies power and continued rotation increases volume. Pulling the knob out enhances the Morse code station identifier when background noise is present; push the knob to hear voice transmissions. A good operating practice is to pull the knob out for station identification purposes and then push it back in after positive identification has been made.

**THIS PAGE INTENTIONALLY LEFT BLANK**

PILOT'S OPERATING HANDBOOK  
AND  
FAA APPROVED AIRPLANE FLIGHT MANUAL  
  
SUPPLEMENT NO. 10  
FOR  
GARMIN GMA 340 AUDIO PANEL

This supplement must be attached to the Pilot's Operating Handbook and FAA Approved Airplane Flight Manual when the Garmin GMA 340 is installed per the Equipment List. The information contained herein supplements or supersedes the information in the basic Pilot's Operating Handbook and FAA Approved Airplane Flight Manual only in those areas listed herein. For limitations, procedures, and performance information not contained in this supplement, consult the basic Pilot's Operating Handbook and FAA Approved Airplane Flight Manual.

FAA APPROVED Christina L. Marsh  
CHRISTINA L. MARSH  
D.O.A. NO. SO-1  
THE NEW PIPER AIRCRAFT, INC.  
VERO BEACH, FLORIDA

DATE OF APPROVAL September 14, 2000

ISSUED: JULY 12, 1995  
REVISED: SEPTEMBER 14, 2000

REPORT: VB-1612  
1 of 6, 9-63

**SECTION 1 - GENERAL**

This supplement supplies information necessary for the operation of the airplane when the Garmin GMA 340 audio panel is installed in accordance with FAA approved Piper data.

**SECTION 2 - LIMITATIONS**

No change.

**SECTION 3 - EMERGENCY PROCEDURES**

No change.

**SECTION 4 - NORMAL PROCEDURES**

**AUDIO CONTROL SYSTEM OPERATION:**

- Select the desired transmitter audio selector button (COM1, COM2, OR COM3) and verify that the buttons LED is illuminated.
- INTERCOM VOL Control (ICS) - Adjust to desired listening level.
- INTERCOM VOX (voice) Sensitivity Control - ROTATE CONTROL knob clockwise to the middle range and then adjust as required for desired voice activation or hot mic intercom.
- If desired, select the speaker function button. Selecting this button allows radio transmissions to be received over the cabin speaker.

**NOTE**

Audio level is controlled by the selected NAV radio volume control.

**MARKER BEACON RECEIVER OPERATION:**

- TEST Button - PRESS to verify all marker lights are operational.
- SENS Button - SELECT HI for airway flying for LO for ILS/LOC approaches.

**SECTION 5 - PERFORMANCE**

No change.

**SECTION 6 - WEIGHT AND BALANCE**

Factory installed optional equipment is included in the licensed weight and balance data in section 6 of the Airplane Flight Manual.

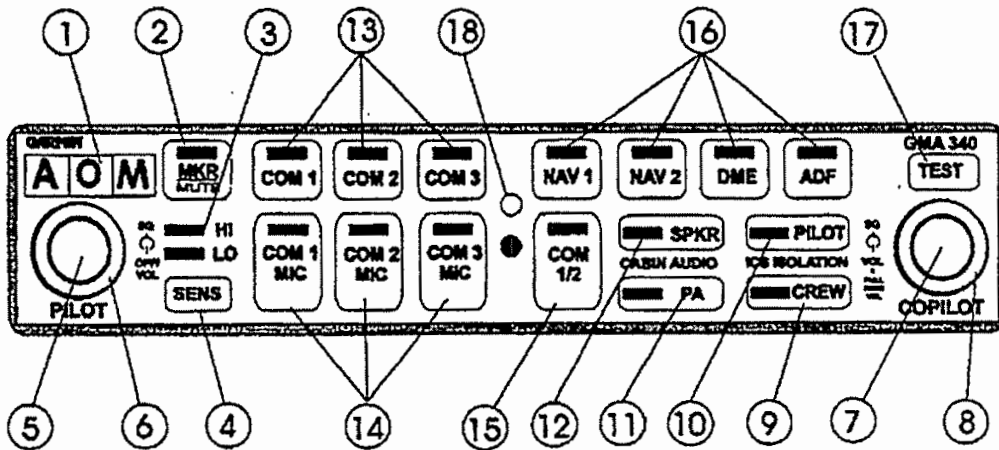
**SECTION 7 - DESCRIPTION AND OPERATION**

1. Marker Beacon Lamps
2. Marker Beacon Receiver Audio Select/Mute Button
3. Marker Beacon Receiver Sensitivity Selection Indicator LED
4. Marker Beacon Receiver Sensitivity Selection Button
5. Unit On/Off, Pilot Intercom System (ICS) Volume
6. Pilot ICS Voice Activated (VOX) Intercom Squelch Level
7. Copilot and Passenger ICS Volume Control (Pull out for Passenger Volume)
8. Copilot/Passenger VOX Intercom Squelch Level
9. Crew Isolation Intercom Mode Button
10. Pilot Isolation Intercom Mode Button
11. Passenger Address (PA) Function Button
12. Speaker Function Button
13. Transceiver Audio Selector Buttons (COM1, COM2, COM3)
14. Transmitter (Audio/Mic) Selection Buttons
15. Split COM Button
16. Aircraft Radio Audio Selection Buttons (NAV1, NAV2, DME, ADF)
17. Annunciator Test Button
18. Photocell - Automatic Annunciator Dimming

**SECTION 7 - DESCRIPTION AND OPERATION (continued)**

**ON/OFF, Pilot Intercom System (ICS) Volume Control**

The GMA 340 is powered OFF when the left small knob (5) is rotated fully CCW into the detent. To turn the unit ON, rotate the knob clockwise past the click. The knob then functions as the pilot ICS volume control. A fail safe circuit connects the pilot's headset and microphone directly to COM1 in case power is interrupted or the unit is turned OFF.

**Transceivers**

Selection of either COM1, COM2, or COM3 for both MIC and audio source is accomplished by pressing either COM1, MIC, COM2 MIC, COM3 MIC (14). The activeCOM audio is always heard on the headphones.

Additionally, each audio source can be selected independently by pressing COM1, COM2, or COM3 (13). When selected this way, they remain active as audio sources regardless of which transceiver has been selected for microphone use.

When a microphone is keyed, the active transceiver's MIC button LED blinks approximately one per second to indicate that the radio is transmitting.

**NOTE**

Audio level is controlled by the selected COM radio volume controls.

**Split COM**

Pressing the COM 1/2 button (15) activates the split COM function. When this mode is active, COM1 is dedicated solely to the pilot for MIC/Audio while COM2 is dedicated to the copilot for MIC/Audio. The pilot and copilot can simultaneously transmit in this mode over separate radios. Both pilots can still listen to COM3, NAV1, NAV2, DME, ADF, and MRK as selected. The split COM mode is cancelled by pressing the COM 1/2 button a second time.

When in the split COM mode the copilot may make PA announcements while the pilot continues using COM1 independently. When the PA button is pressed after the split com mode is activated the copilot's mic is output over the cabin speaker when keyed. A second press of the PA button returns the copilot to normal split COM operation.



**SECTION 7 - DESCRIPTION AND OPERATION (continued)****Aircraft Radios and Navigation**

Pressing NAV1, NAV2, DME, ADF (16) or MRK (2) selects each audio source. A second button press deselects the audio.

**Speaker Output**

Pressing the SPKR button (12) selects the aircraft radios over the cabin speaker. The speaker output is muted when a COM microphone is keyed.

**PA Function**

The PA mode is activated by pressing the PA button (11). Then, when either the pilot's or copilot's microphone is keyed, the corresponding mic audio is heard over the cabin speaker. If the SKR button is also active, then any selected speaker audio is muted while the microphone is keyed. The SPKR button does not have to be previously active in order to use the PA function.

**Intercom System (ICS)**

Intercom volume and squelch (VOX) are adjusted using the following front panel knobs:

- **Left Small Knob** - Unit ON/OFF power control and pilot's ICS volume. Full CCW detent position is OFF.
- **Left Large Knob** - Pilot ICS mic VOX squelch level. CW rotation increases the amount of mic audio (VOX level) required to break squelch. Full CCW is the "HOT MIC" position (no squelch).
- **Right Small Knob** - IN position: Copilot ICS volume. OUT position: Passenger ICS volume.
- **Right Large Knob** - Copilot and passenger mic VOX squelch level. CW rotation increases the amount of mic audio (VOX level) required to break squelch. Full CCW is the "HOT MIC" position.
- **PILOT Mode** - This mode isolates the pilot from everyone else and dedicates the aircraft radios to the pilot exclusively. The copilot and passengers share communications between themselves but cannot communicate with the pilot or hear the aircraft radios.
- **CREW Mode** - This mode places the pilot and copilot on a common ICS communication channel with the aircraft radios. The passengers are on their own intercom channel and can communicate with each other, but cannot communicate with the crew or hear the aircraft radios.

**SECTION 7 - DESCRIPTION AND OPERATION (continued)****Marker Beacon Receiver**

The GMA 340's marker beacon receiver controls are located on the left side of the front panel (1 - 4). The SENS button selects either high or low sensitivity as indicated by the HI or LO LED being lit. Low sensitivity is used on ILS approaches while high sensitivity allows operation over airway markers or to get an earlier indication of nearing the outer marker during an approach.

The marker audio is initially selected by pressing the MKR/Mute button (2). If no beacon signal is received, then a second button press will deselect the marker audio. This operation is similar to selecting any other audio source on the GMA 340. However, if the second button press occurs while a marker beacon signal is received, then the marker audio is muted but not deselected. The button's LED will remain lit to indicate that the source is still selected. When the current marker signal is no longer received, the audio is automatically un-muted. While in the muted state, pressing the MKR/Mute button deselects the marker audio. The button's LED will extinguish to indicate that the marker audio is no longer selected.

**PILOT'S OPERATING HANDBOOK  
AND  
FAA APPROVED AIRPLANE FLIGHT MANUAL**

**SUPPLEMENT NO. 11  
FOR  
S-TEC DME-450**

This supplement must be attached to the Pilot's Operating Handbook and FAA Approved Airplane Flight Manual when the S-TEC DME-450 is installed per the Equipment List. The information contained herein supplements or supersedes the Pilot's Operating Handbook and FAA Approved Airplane Flight Manual only in those areas listed herein. For limitations, procedures and performance information not contained in this supplement, consult the Pilot's Operating Handbook and FAA Approved Airplane Flight Manual.

FAA APPROVED:

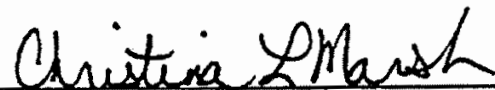

CHRISTINA L. MARSH

D.O.A. NO. SO- 1

THE NEW PIPER AIRCRAFT, INC.

VERO BEACH, FLORIDA

DATE OF APPROVAL: September 14, 2000

**ISSUED: JULY 12, 1995**  
**REVISED: SEPTEMBER 14, 2000**

**REPORT: VB-1612**  
**1 of 4, 9-69**

## SECTION 1 - GENERAL

The S-TEC DME-450 system is a full feature, solid state, remote mounted system with full 200 channel capability. For long distance operation, it provides a full 100 watts maximum pulse power transmitter output.

The IND-450 indicator (see figure 1) provides selectable read-out of distance to/from the station, ground speed, and time to/from the station. Features also include automatic display dimming and waypoint annunciation.

## SECTION 2 - LIMITATIONS

No change.

## SECTION 3 - EMERGENCY PROCEDURES

No change.

## SECTION 4 - NORMAL PROCEDURES

### DME OPERATION

- DME Mode Selector Switch - Set to DME 1 or DME 2
- NAV 1 and NAV 2 VHF Navigation Receivers - ON; SET FREQUENCY to VOR/DME station frequencies, as required.

### NOTE

When the VOR frequency is selected, the appropriate DME Frequency is automatically channeled.

- DME audio selector button (on audio selector panel) - SET to desired mode.

## SECTION 5 - PERFORMANCE

No change.

## SECTION 6 - WEIGHT AND BALANCE

Factory installed optional equipment is included in the licensed weight and balance data in Section 6 of the Pilot's Operating Handbook and Airplane Flight Manual.

## SECTION 7 - DESCRIPTION AND OPERATION

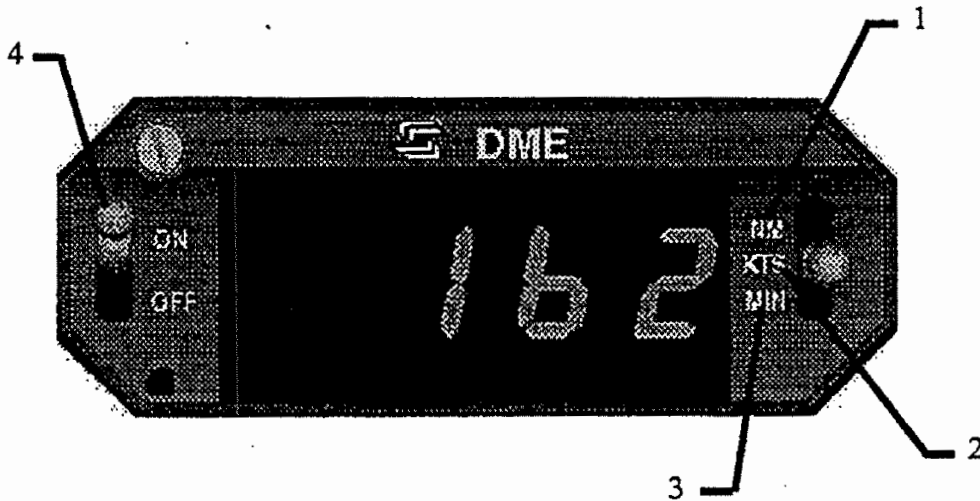

IND-450  
Figure 1

1. DISTANCE DISPLAY (NM) - DME distance to VORTAC/WAYPOINT displayed in .1 nautical mile increments up to 99.9 NM, then in increments of one nautical mile.
2. GROUND SPEED DISPLAY (KTS) - Displays ground speed in knots to or from VORTAC/WAYPOINT up to 999 knots (aircraft must be flying directly to or from the VORTAC/WAYPOINT for true ground speed indication).
3. TIME TO STATION DISPLAY (MIN) - Displays time to station (VORTAC/WAYPOINT) in minutes up to 99 minutes (aircraft must be flying directly to or from the VORTAC/WAYPOINT for true time to the station indication).

## 7 - DESCRIPTION AND OPERATION (continued)

4. DME ON/OFF SWITCH - Turns DME power on or off.

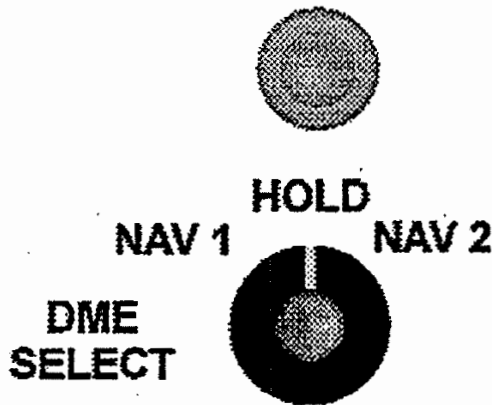

**Mode Selector Switch**

**Figure 2**

5. DME MODE SELECTOR SWITCH (NAV 1, HOLD, NAV 2) - Selects DME operating mode as follows:

NAV 1 - Selects DME operation with NO. 1 VHF navigation set; enables channel selection by NAV 1 frequency selector controls.

HOLD - Selects DME memory circuit; DME remains channeled to station to which it was last channeled when HOLD was selected and will continue to display information relative to this channel. Allows both the NAV 1 and NAV 2 navigation receivers to be set to new operational frequencies without affecting the previously selected DME operation.

**NOTE**

In the HOLD mode there is no annunciation of the VOR/DME station frequency. However, an annunciator light located above the HOLD position of the selector illuminates to inform the pilot that the DME is in the HOLD mode.

NAV 2 - Selects DME operation with NO. 2 VHF navigation set; enables channel selection by NAV 2 frequency selector controls.

**PILOT'S OPERATING HANDBOOK  
AND  
FAA APPROVED AIRPLANE FLIGHT MANUAL**

**SUPPLEMENT NO. 12  
FOR  
S-TEC SYSTEM 55 TWO AXIS  
AUTOMATIC FLIGHT GUIDANCE SYSTEM**

The FAA approved operational supplement for the S-TEC System 55 Autopilot, installed in accordance with STC SA09129AC-D, is required for operation of this system. S-TEC will be responsible to supply and revise the operational supplement. It is permitted to include the S-TEC supplement in this location of the Pilot's Operating Handbook unless otherwise stated by S-TEC. The information contained in the S-TEC supplement may supersede or supplement the information in the basic Pilot's Operating Handbook and FAA Approved Airplane Flight Manual with respect to the operation of the S-TEC System 55 Autopilot. For limitations, procedures and performance information not contained in the S-TEC supplement, consult the basic Pilot's Operating Handbook and FAA Approved Airplane Flight Manual.

**ISSUED: JULY 12, 1995  
REVISED: SEPTEMBER 14, 2000**

**REPORT: VB-1612  
9-73**

**THIS PAGE INTENTIONALLY LEFT BLANK**



**PILOT'S OPERATING HANDBOOK  
AND  
FAA APPROVED AIRPLANE FLIGHT MANUAL**

**SUPPLEMENT NO. 13  
FOR  
S-TEC SYSTEM 55X TWO AXIS  
AUTOMATIC FLIGHT GUIDANCE SYSTEM**

The FAA approved operational supplement for the S-TEC System 55X Autopilot, installed in accordance with STC SA09129AC-D, is required for operation of this system. S-TEC will be responsible to supply and revise the operational supplement. It is permitted to include the S-TEC supplement in this location of the Pilot's Operating Handbook unless otherwise stated by S-TEC. The information contained in the S-TEC supplement may supersede or supplement the information in the basic Pilot's Operating Handbook and FAA Approved Airplane Flight Manual with respect to the operation of the S-TEC System 55X Autopilot. For limitations, procedures and performance information not contained in the S-TEC supplement, consult the basic Pilot's Operating Handbook and FAA Approved Airplane Flight Manual.

**ISSUED: JULY 12, 1995  
REVISED: DECEMBER 21, 2000**

**REPORT: VB-1612  
9-75**

**THIS PAGE INTENTIONALLY LEFT BLANK**

S-TEC CORPORATION  
MINERAL WELLS, TEXAS 76067

FAA/DAS APPROVED  
PILOT'S OPERATING HANDBOOK AND/OR  
AIRPLANE FLIGHT MANUAL SUPPLEMENT  
FOR  
PIPER MODELS PA-28R-201 AND PA-28R-201T  
WITH  
S-TEC SYSTEM 55/55X TWO AXIS  
AUTOMATIC FLIGHT GUIDANCE SYSTEM  
WITH TRIM MONITOR  
(14 Volt System)

REG. NO. N30645

SER. NO. 2844120

This Supplement must be attached to the applicable FAA Approved Airplane Flight Manual, Pilot's Operating Handbook, or Pilot's Operating Handbook and FAA Approved Airplane Flight Manual for aircraft modified by the installation of S-TEC System 55/55X Autopilot Model ST-610 installed in accordance with STC SA09129AC-D. The information contained herein supplements or supersedes the basic manual. For limitations, procedures and performance information not contained in this supplement, consult the basic Pilot's Operating Handbook and/or Airplane Flight Manual.

SECTION I

GENERAL

This manual is to acquaint the pilot with the features and functions of the System 55/55X Two Axis Autopilot and to provide operating instructions for the system when installed in the listed aircraft model(s). The aircraft must be operated within the limitations herein provided when the autopilot is in use.

FAA/DAS APPROVED

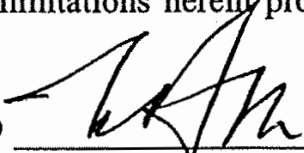

*For* James L. Irwin

S-TEC CORPORATION  
DAS 5 SW  
P/N: 892033 ✓  
DATE: 5-16-00

S-TEC CORPORATION  
MINERAL WELLS, TEXAS 76067

FAA/DAS APPROVED  
PILOT'S OPERATING HANDBOOK AND/OR  
AIRPLANE FLIGHT MANUAL SUPPLEMENT  
FOR  
Piper models PA-28R-201 and PA-28R-201T

LOG OF REVISIONS

| REV. NO. | PAGES AFFECTED      | DESCRIPTION   | APPROVED   | DATE     |
|----------|---------------------|---|------------|----------|
| 1        | 1, 3, 5, 10, 11, 12 | Added System 55X information. Removed Optional Equipment Section. Renumbered pages. | <i>WFO</i> | 11-20-00 |

FAA/DAS APPROVED

P/N: 892033

DATE: 5-16-00

S-TEC CORPORATION  
MINERAL WELLS, TEXAS 76067

FAA/DAS APPROVED  
PILOT'S OPERATING HANDBOOK AND/OR  
AIRPLANE FLIGHT MANUAL SUPPLEMENT  
FOR  
Piper models PA-28R-201 and PA-28R-201T

.....

SECTION II

OPERATING LIMITATIONS

1. Autopilot operation not authorized above 165 KIAS.
2. Flap extension limited to two (2) notches (25°) or less during autopilot operations.
3. Go around or missed approach maneuvers not authorized during autopilot operation.
4. Autopilot use prohibited during take off and landing.
5. Category I operations only.
6. S-TEC System 55 Pilot's Operating Handbook, P/N 8747, dated 10-16-00 or later revision, or S-TEC System 55X Pilot's Operating Handbook, P/N 87109, dated 11-08-00 or later revision, must be carried in the aircraft and be available to the pilot while in flight.

SECTION III

EMERGENCY OPERATING PROCEDURES

In the event of an autopilot malfunction, or anytime the autopilot is not performing as expected or commanded, do not attempt to identify the system problem. Immediately regain control of the aircraft by overpowering the autopilot as necessary and then immediately disconnect the autopilot. Do not re-engage the autopilot until the problem has been identified and corrected.

FAA/DAS APPROVED  
P/N: 892033  
DATE: 5-16-00

S-TEC CORPORATION  
MINERAL WELLS, TEXAS 76067

FAA/DAS APPROVED  
PILOT'S OPERATING HANDBOOK AND/OR  
AIRPLANE FLIGHT MANUAL SUPPLEMENT  
FOR  
Piper models PA-28R-201 and PA-28R-201T

1. The autopilot may be disconnected by:

- a. Depressing the "AP Disconnect" Switch on the left horn of the pilot's control wheel.
- b. Placing the "AP Master Switch" in the "OFF" position.
- c. Momentarily interrupting aircraft electrical power at the battery master switch.
- d. Pulling the autopilot circuit breaker.

2. Trim:

- a. In the event of a trim failure, manually control aircraft and DEPRESS AND HOLD "Trim Interrupt/AP Disconnect Switch" on control wheel.
- b. Place trim master switch in "OFF" position, pull circuit breaker, release interrupt switch.
- c. Retrim aircraft. Leave trim system OFF until corrected.

3. Altitude loss during a malfunction and recovery:

- a. The following altitude losses and bank angles were recorded after a malfunction with a 3 second recovery delay:

| <u>Configuration</u> | <u>Bank Angle/Altitude Loss</u> |
|----------------------|---------------------------------|
| Climb                | 55°/NONE                        |
| Cruise               | 60°/-200'                       |
| Descent              | 60°-280'                        |

FAA/DAS APPROVED  
P/N: 892033  
DATE: 5-16-00

S-TEC CORPORATION  
MINERAL WELLS, TEXAS 76067

FAA/DAS APPROVED  
PILOT'S OPERATING HANDBOOK AND/OR  
AIRPLANE FLIGHT MANUAL SUPPLEMENT  
FOR  
Piper models PA-28R-201 and PA-28R-201T

---

- b. The following altitude losses and bank angles were recorded after a malfunction with a 1 second recovery delay:

| <u>Configuration</u>               | <u>Bank Angle/Altitude Loss</u> |
|------------------------------------|---------------------------------|
| Maneuvering                        | 18°/-40'                        |
| Approach (Coupled or<br>Uncoupled) | 20°/-20'                        |

The above values are the worst case for all the models covered by this document.

#### SECTION IV

#### NORMAL OPERATING PROCEDURES

For detailed normal operating procedures, including system description, pre-flight and in flight procedures refer to S-TEC System 55 Pilot's Operating Handbook, P/N 8747, dated 10-16-00 or later revision, or S-TEC System 55X Pilot's Operating Handbook, P/N 87109, dated 11-08-00 or later revision.

**CAUTION:** When S-TEC Flight Director is installed and operating, the Flight Director Autopilot should be disconnected using the control wheel disconnect switch only. Any other means of disconnect (breaker, ON-OFF switch, etc.) may leave steering bars in view, but inoperable.

**NOTE:** For smoother altitude captures, thus enhancing passenger comfort, engage altitude hold mode at rates of climb of 1,000 FPM or less.

FAA/DAS APPROVED

P/N: 892033

DATE: 5-16-00

S-TEC CORPORATION  
MINERAL WELLS, TEXAS 76067

FAA/DAS APPROVED  
PILOT'S OPERATING HANDBOOK AND/OR  
AIRPLANE FLIGHT MANUAL SUPPLEMENT  
FOR  
Piper models PA-28R-201 and PA-28R-201T

.....  
CONTROL WHEEL SWITCHES

The left grip of the pilot's control wheel will normally contain the following autopilot switches:

- Manual Electric Trim
- Trim Interrupt/A/P Disconnect Switch
- Control Wheel Steering (CWS)

If the optional co-pilot switch arrangement is installed, the same three switches with the same functions will be installed in the right grip of the co-pilot's control wheel.

ELECTRIC TRIM SYSTEM

The S-TEC Electric Trim System is designed to accept any single failure, either mechanical or electrical, without uncontrolled operation resulting during operations in the Manual Electric Trim Mode. During autotrim mode the system is designed to limit the effect of any failure causing trim operation. In order to assure proper operation of these safeguards, it is necessary to conduct a simple pre-flight test of the system. Following is a brief description and a preflight test procedure for the trim system.

FAA/DAS APPROVED  
P/N: 892033  
DATE: 5-16-00



S-TEC CORPORATION  
MINERAL WELLS, TEXAS 76067

FAA/DAS APPROVED  
PILOT'S OPERATING HANDBOOK AND/OR  
AIRPLANE FLIGHT MANUAL SUPPLEMENT  
FOR  
Piper models PA-28R-201 and PA-28R-201T

---

TRIM SYSTEM WITH TRIM MONITOR

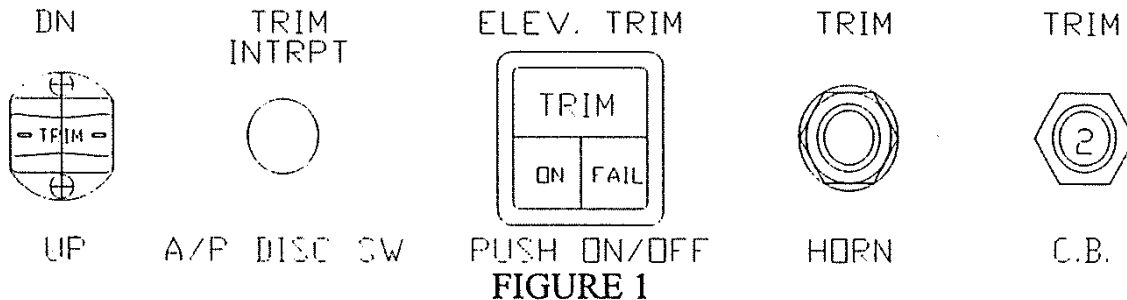

FIGURE 1

SYSTEM DESCRIPTION

The trim monitor system consists of the components pictured in Figure 1 and is designed to alert the pilot of a trim failure or trim in motion.

The system is activated by pushing the trim master switch on. A green On light, a yellow Trim light and a red Fail light will illuminate in the switch and the trim audio horn will activate for one second, as a test. A trim fault will cause the Trim and Fail lights to illuminate along with continuous horn operation. The pilot should press and hold the red Trim Interrupt button and conduct the emergency procedures listed in Section III of this AFMS.

PREFLIGHT TRIM CHECK (With Trim Monitor)

MANUAL ELECTRIC TRIM - Test Prior To Each Flight

1. Check trim circuit breaker – IN
2. Trim master switch - Push ON - confirm green light ON after completion of test cycle.

FAA/DAS APPROVED  
P/N: 892033  
DATE: 5-16-00

S-TEC CORPORATION  
MINERAL WELLS, TEXAS 76067

FAA/DAS APPROVED  
PILOT'S OPERATING HANDBOOK AND/OR  
AIRPLANE FLIGHT MANUAL SUPPLEMENT  
FOR  
Piper models PA-28R-201 and PA-28R-201T

3. A/P master switch - ON
4. Operate trim switch (both knob sections) - NOSE DN. Check that trim moves nose down and yellow trim light in trim master switch flashes while trim is in motion. The trim "in motion" indicator in the autopilot programmer should flash "TRIM" also. Conduct the same test in the NOSE UP direction.
5. With trim operating up or down depress the red control wheel interrupt switch for three seconds minimum. Confirm that trim action stops while switch is pressed. This action should also trigger the trim monitor horn with "Trim" steady and "Fail" flashing in the trim master switch. Recycle the trim master switch to delete the horn.
6. Overpower check - With trim operating electrically, grasp the manual trim wheel and overpower the electric trim to stop trim motion.
7. Operate each half of the trim switch separately - Trim should not operate unless both switch knob segments are moved together.

AUTOTRIM

1. Position elevator control half way aft from full forward.
2. Engage HDG and ALT modes of autopilot.
3. Grasp control and slowly apply forward pressure (nose down). After approximately 3 seconds automatic trim should run NOSE UP. The yellow trim indicator in trim master switch should flash simultaneously with the trim indicator in the A/P programmer.
4. Conduct the same test by slowly applying aft pressure on the elevator control, confirming that autotrim runs NOSE DOWN and trim indicators flash while trim is in motion.
5. Move manual trim switch up or down - Autopilot should disconnect and trim should operate in the commanded direction. (Trim switch

FAA/DAS APPROVED

P/N: 892033

DATE: 5-16-00

S-TEC CORPORATION  
MINERAL WELLS, TEXAS 76067

FAA/DAS APPROVED  
PILOT'S OPERATING HANDBOOK AND/OR  
AIRPLANE FLIGHT MANUAL SUPPLEMENT  
FOR  
Piper models PA-28R-201 and PA-28R-201T

---

- will disconnect A/P only when a pitch mode is engaged.)
6. Reengage autopilot HDG and ALT modes - Press trim interrupt/AP disconnect switch - Autopilot should disconnect:
  7. Retrim aircraft for take off - Check all controls for freedom of motion and determine that autopilot and trim have disconnected.

If either the manual electric or autotrim fails any portion of the above check procedure, push the Trim Master Switch "OFF" and do not attempt to use the trim system until the fault is corrected. With the Trim Master Switch "OFF" the autopilot trim indicators will return to operation. If the electric trim system suffers a power failure in flight the system will automatically revert to the trim indicator lights located in the autopilot annunciator panel. If this occurs push the Trim Master Switch "OFF" and trim manually, using the indicators until the fault can be located and corrected.

GLIDE SLOPE FLIGHT PROCEDURE

Approach the GS intercept point (usually the O.M.) with the flaps set to approach deflection of 10° - 25° (See Limitations Section) and with the aircraft stabilized in altitude hold mode. At the glide slope intercept, lower the landing gear and adjust power for desired descent speed. For best tracking results make power adjustments in small, smooth increments to maintain desired airspeed. At the missed approach point or the decision height, disconnect the autopilot for landing or for the go-around maneuver (See Limitations Section). If a missed approach is required, the autopilot may be reengaged after the aircraft has been reconfigured for and established in a stabilized climb.

FAA/DAS APPROVED  
P/N: 892033  
DATE: 5-16-00

S-TEC CORPORATION  
MINERAL WELLS, TEXAS 76067

FAA/DAS APPROVED  
PILOT'S OPERATING HANDBOOK AND/OR  
AIRPLANE FLIGHT MANUAL SUPPLEMENT  
FOR  
Piper models PA-28R-201 and PA-28R-201T

.....

**NOTE: The landing gear may be lowered at 129 KIAS to slow the aircraft to the flap speed of 103 KIAS. But in any case, the aircraft should be configured and stabilized in altitude hold mode before reaching glide slope intercept, for optimum results.**

SECTION V

PERFORMANCE

The text of this Section not affected by installation of this equipment.

SECTION VI

WEIGHT AND BALANCE

The text of this Section not affected by installation of this equipment.

SECTION VII

DESCRIPTION AND OPERATION OF THE AIRPLANE AND ITS SYSTEMS

The text of this Section not affected by installation of this equipment.

SECTION VIII

AIRPLANE HANDLING, SERVICING AND MAINTENANCE

The text of this Section not affected by installation of this equipment.

FAA/DAS APPROVED  
P/N: 892033  
DATE: 5-16-00

S-TEC CORPORATION  
MINERAL WELLS, TEXAS 76067

FAA/DAS APPROVED  
PILOT'S OPERATING HANDBOOK AND/OR  
AIRPLANE FLIGHT MANUAL SUPPLEMENT  
FOR  
Piper models PA-28R-201 and PA-28R-201T

---

SECTION IX

SUPPLEMENTS

Refer to contents of this supplement for operation for System 55/55X  
Automatic Flight Control System.

SECTION X

OPERATING TIPS

The text of this Section not affected by installation of this equipment.

FAA/DAS APPROVED  
P/N: 892033  
DATE: 5-16-00

**PILOT'S OPERATING HANDBOOK  
AND  
FAA APPROVED AIRPLANE FLIGHT MANUAL**

**SUPPLEMENT NO. 14  
FOR  
S-TEC ADF-650D SYSTEM**

This supplement must be attached to the Pilot's Operating Handbook and FAA Approved Airplane Flight Manual when the S-TEC ADF-650D System is installed per the equipment list. The information contained herein supplements or supersedes the Pilot's Operating Handbook and FAA Approved Airplane Flight Manual only in those areas listed herein. For limitations, procedures, performance and loading information not contained in this supplement, consult the Pilot's Operating Handbook and FAA Approved Airplane Flight Manual.

FAA APPROVED:

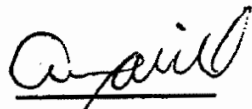

ALBERT J. MILL  
D.O.A. NO. SO- 1  
THE NEW PIPER AIRCRAFT, INC.  
VERO BEACH, FLORIDA

DATE OF APPROVAL: DECEMBER 20, 2001

ISSUED: JULY 12, 1995  
REVISED: DECEMBER 20, 2001

REPORT: VB-1612  
1 of 10, 9-77

## SECTION 9

### SUPPLEMENT 14

PA-28R-201, ARROW

---

#### SECTION 1 - GENERAL

This supplement supplies information necessary for the operation of the airplane when the S-TEC ADF-650D System is installed in accordance with FAA approved Piper data.



#### SECTION 2 - LIMITATIONS

No change.



#### SECTION 3 - EMERGENCY PROCEDURES

No change.



**SECTION 4 - NORMAL PROCEDURES****To turn on the ADF-650D System:**

- Depress the PWR button momentarily and release.

**NOTE**

If the PWR button is pressed for longer than 3 seconds, the receiver will immediately shut off.

- After successful self test, input desired station frequency and select ANT mode.
- Positively identify selected station or beacon.
- Adjust volume control as required.
- If ADF-650D System is used for navigation, select ADF or BFO mode immediately after the station has been positively identified.

**To turn off the ADF-650D System:**

- Depress the PWR button for at least 3 seconds.

**NOTE**

If the PWR button is released within 3 seconds, normal operations will resume.



**SECTION 4 - NORMAL PROCEDURES (continued)**

**To perform the preflight checklist and self test:**

- After successful self test, press the mode control until ANT is displayed and input a predetermined frequency to select a station in the immediate area. Adjust the volume control as necessary to provide a comfortable listening level.
- Press the ID button and observe that the station identification code becomes louder (if the station is voice-identified, it is not necessary to press the ID button).
- Press the ID button again to cancel the IDENT function and press the mode control until ADF is displayed.
- Observe the IND-650A Indicator and note that the bearing pointer indicates the relative bearing to the station.
- Push the TEST button while observing the indicator bearing pointer. The bearing pointer will rotate 90° and stop.
- Push the TEST button again (to turn off test function). The bearing pointer returns to the original relative bearing position.
- Switch to BFO mode, if appropriate, and verify a tone is present. Select the appropriate operating mode when all checks have been completed.

**SECTION 5 - PERFORMANCE**

No change.

**SECTION 6 - WEIGHT AND BALANCE**

Factory installed optional equipment is included in the licensed weight and balance data in Section 6 of the Pilot's Operating Handbook and Airplane Flight Manual.

## SECTION 7 - DESCRIPTION AND OPERATION

The S-TEC ADF-650D System operates over a frequency range of 200 through 1799 kHz in 1-kHz increments. Three operating modes are included as part of the ADF-650D System.

- BFO
- ADF
- ANT

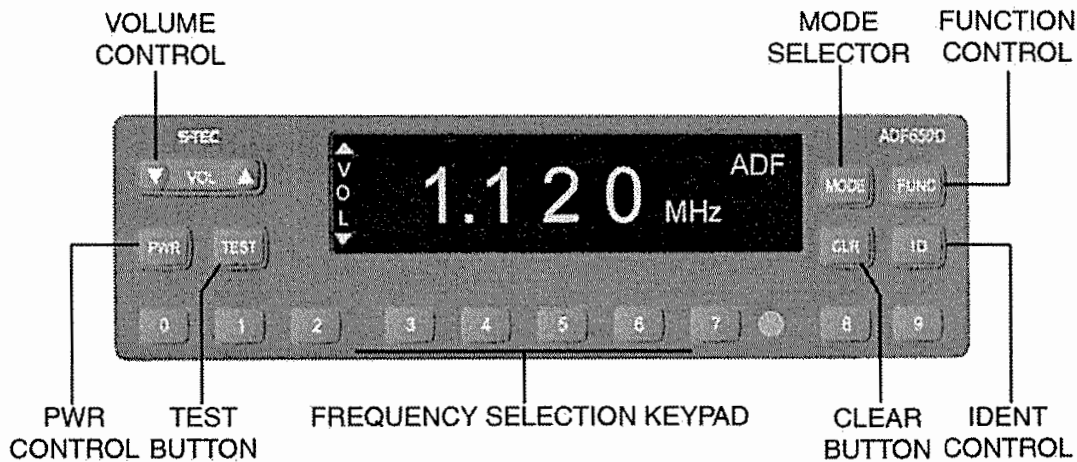

## RCR-650D Receiver Controls

## Beat Frequency Oscillator (BFO) Mode

The BFO (beat frequency oscillator) mode is used to aurally identify stations that employ keyed CW (Carrier Wave) rather than amplitude modulation techniques. This mode activates the bearing pointer. The bearing pointer will point in the direction of the station relative to the aircraft heading.

## NOTE

CW signals (Morse Code) are unmodulated and no audio will be heard without use of BFO. This type of signal is not used in the United States air navigation. It is used in some foreign countries and marine beacons.

**SECTION 7 - DESCRIPTION AND OPERATION (continued)**

**Automatic Direction Finder (ADF) Mode**

The Automatic Direction Finder (ADF) mode uses conventional nondirectional beacons and AM broadcast stations for navigation. This mode activates the bearing pointer. The bearing pointer will point in the direction of the station relative to the aircraft heading.

**Antenna (ANT) Mode**

The ANT (antenna) mode cannot be used for navigation; this mode enhances audio reception clarity and is normally used for station identification.

**Frequency Selection Keypad**

The Frequency Selection Keypad is used to select the system operating frequency. The keypad consists of a row of numbered buttons from 0 to 9, located along the bottom of the RCR-650D Receiver. Frequencies in the megahertz and kilohertz range may be selected.

**Power (PWR) Control**

The power control is used to turn the receiver on and off. Momentarily depressing the PWR button will turn the receiver on and also initiate a self test.

**NOTE**

If the PWR button is pressed for longer than 3 seconds the receiver will immediately shut off.

**SECTION 7 - DESCRIPTION AND OPERATION (continued)****Clear (CLR)**

The clear function offers several options for the operator.

- If the entire frequency is entered and the CLR button is pushed, all the numbers will become dashes. An additional push on the CLR button will restore and display the prior frequency entry.
- If an entry is in progress and a number is entered in error, pressing the CLR button will erase the last number entry.
- Pressing the CLR button while in the contrast function reverses the display image and also places the receiver in manual mode.

**NOTE**

It is not necessary to push CLR to enter a new frequency number. Simply complete the entry and then enter the new numbers and they will replace the old frequency.

**Volume (VOL) Control**

The audio volume control is used to adjust the settings and levels for all function selector and setup modes and is controlled by pressing the  $\wedge$  and  $\vee$  buttons on the VOL control.

**SECTION 7 - DESCRIPTION AND OPERATION (continued)****Function (FUNC) Selector**

The function selector enables the user to select between contrast and volume display functions (on power-up, the RCR-650D will be in the volume display function). The first time the function selector is pressed, the receiver enters the contrast function. Subsequent presses of the function selector button toggles the unit between contrast and volume. Additionally, pressing the clear button while in the contrast function places the receiver in manual mode. In manual mode, subsequent pushes of the function selector will cycle the receiver through four functions: volume, contrast, display and keypad.

- **Volume**



The volume control function is available on power-up and is accessed immediately by pressing the  $\wedge$  and  $\vee$  buttons on the VOL control. Upon activation, the kHz and mode annunciations are temporarily replaced by the text "VOLUME" with a horizontal fill bar. The filled portion of the bar indicates the current volume setting.

- **Contrast**



The contrast function is activated by pressing the FUNC selector. Upon activation, the kHz and mode annunciation are temporarily replaced by the text "CONTRAST" with a horizontal fill bar on the right side of the annunciator panel. The filled portion of the bar indicates the current contrast setting. The contrast is adjusted by pressing the appropriate  $\wedge$  and  $\vee$  indicators on the volume control.

- **Display**



When the display is setup in the manual mode, press the FUNC selector until the display function is selected. The display function is then activated and the kHz and mode annunciations are temporarily replaced by the text "DISPLAY" with a horizontal fill bar on the right side of the annunciator panel. The filled portion of the bar indicates the current display setting. The display is adjusted by pressing the appropriate  $\wedge$  and  $\vee$  indicators on the volume control.

## SECTION 7 - DESCRIPTION AND OPERATION (continued)

## Function (FUNC) Selector - continued

- Keypad Light Brightness



The keypad light brightness setting is used to adjust the brightness of all legends on the display face. When the display is setup in the manual mode, press the FUNC selector until the keypad function is selected. The keypad function is then displayed with the text “KEYPAD” and a horizontal fill bar on the right side of the annunciator panel. The filled portion of the bar indicates the current keypad brightness setting. The brightness is adjusted by pressing the appropriate  $\wedge$  and  $\vee$  indicators on the volume control.

## Mode Selector



The mode selector is used to select one of the three operating states: BFO, ADF, or ANT. Pressing the MODE selector button will step the receiver through the three modes. The current mode will be displayed in the upper right corner of the display. On system power-up, the mode selector will be in the ADF mode.

## Ident (ID)



The receiver utilizes an Ident Filter for audio output which aids in receiving weak signals. Pressing the ID button toggles the Ident Filter on and off. When the Ident Filter is active, the text “IDENT” is displayed in the bottom right corner of the display.

SECTION 7 - DESCRIPTION AND OPERATION (continued)

Test Mode



Press the TEST button to start the test mode. The text “TEST” will be displayed in the bottom right corner of the display for approximately 15 seconds. During this time, the IND-650A Indicator pointer will incrementally rotate 90°. Press the TEST button again to cancel the test while in this mode. The pointer will immediately return to its starting point.



**PILOT'S OPERATING HANDBOOK  
AND  
FAA APPROVED AIRPLANE FLIGHT MANUAL**

**SUPPLEMENT NO. 15  
FOR  
GARMIN GTX 330 TRANSPONDER**

This supplement must be attached to the Pilot's Operating Handbook and FAA Approved Airplane Flight Manual when the Garmin GTX 330 Transponder is installed per the Equipment List. The information contained herein supplements or supersedes the Pilot's Operating Handbook and FAA Approved Airplane Flight Manual only in those areas listed herein. For limitations, procedures and performance information not contained in this supplement, consult the Pilot's Operating Handbook and FAA Approved Airplane Flight Manual.

FAA APPROVED:

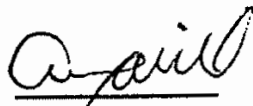

ALBERT J. MILL  
D.O.A. NO. SO - 1  
THE NEW PIPER AIRCRAFT, INC.  
VERO BEACH, FLORIDA

DATE OF APPROVAL: January 5, 2004

ISSUED: JULY 12, 1995  
REVISED: JANUARY 5, 2004

REPORT: VB-1612  
1 of 4, 9-87



**SECTION 1 - GENERAL**

This supplement supplies information necessary for the operation of the airplane when the Garmin GTX 330 Transponder is installed in accordance with FAA approved Piper data.

**SECTION 2 - LIMITATIONS**

- A. Display of TIS traffic information is advisory only and does not relieve the pilot responsibility to “see and avoid” other aircraft. Aircraft maneuvers shall not be predicated on the TIS displayed information.
- B. Display of TIS traffic information does not constitute a TCAS I or TCAS II collision avoidance system as required by 14 CFR Part 121 or Part 135.
- C. Title 14 of the Code of Federal Regulations (14 CFR) states that “When an Air Traffic Control (ATC) clearance has been obtained, no pilot-in-command (PIC) may deviate from that clearance, except in an emergency, unless he obtains an amended clearance.” Traffic information provided by the TIS up-link does not relieve the PIC of this responsibility.
- D. The 400/500 Series Garmin Display Interfaces (Pilot’s Guide Addendum) P/N 190-00140-13 Rev. A or later revision must be accessible to the flight crew during flight.
- E. 400/500 Series Main Software 4.00 or later FAA approved software is required to operate the TIS interface and provide TIS functionality.

**SECTION 3 - EMERGENCY PROCEDURES**

To transmit an emergency signal:

- Mode Selection Key - ALT
- Code Selection - SELECT 7700

To transmit a signal representing loss of all communications:

- Mode Selection Key - ALT
- Code Selection - SELECT 7600

**SECTION 4 - NORMAL PROCEDURES****BEFORE TAKEOFF:**

- To transmit Mode C (Altitude Reporting) code in flight:
- Mode Selection Key - ALT
- Code Selector Keys - SELECT assigned code.

To transmit Mode A (Aircraft Identification) code in flight:

- Mode Selector Key - ON
- Code Selector Keys - SELECT assigned code.

**NOTE**

During normal operation with the ON mode selected, the reply indicator "R" flashes, indicating transponder replies to interrogations.

**NOTE**

Mode A reply codes are transmitted in ALT also; however, Mode C codes only are suppressed when the Function Selector ON key is selected.

**1. DETAILED TRANSPONDER OPERATING PROCEDURES**

Normal transponder operating procedures are described in the GARMIN GTX 330 Pilot's Guide, P/N 190-00207-00, Rev. A, or later appropriate revision.

**2. DISPLAY OF TRAFFIC INFORMATION SERVICE (TIS) DATA**

TIS surveillance data uplinked by Air Traffic Control (ATC) radar through the GTX 330 Mode S Transponder will appear on the interfaced display device (Garmin 400 or 500 series products). For detailed operating instructions and information regarding the TIS interface, refer to the 400/500 Series Garmin Display Interfaces (Pilot's Guide Addendum) P/N 190-00140-13 Rev. A or later appropriate revision.

**SECTION 5 - PERFORMANCE**

No change.



**SECTION 6 - WEIGHT AND BALANCE**

Factory installed optional equipment is included in the licensed weight and balance data in section 6 of the Airplane Flight Manual.

**SECTION 7 - DESCRIPTION AND OPERATION**

See the 400/500 Series Garmin Display Interfaces (Pilot's Guide Addendum), P/N 190-00140-13, and GTX 330 Pilot's Guide, P/N 190-00207-00, for a complete description of the GTX 330 system.



**PILOT'S OPERATING HANDBOOK  
AND  
FAA APPROVED AIRPLANE FLIGHT MANUAL  
  
SUPPLEMENT NO. 16  
FOR  
AVIDYNE FLIGHTMAX ENTEGRA  
PRIMARY FLIGHT/MULTI-FUNCTION DISPLAYS**

This supplement must be attached to the Pilot's Operating Handbook and FAA Approved Airplane Flight Manual when the optional Avidyne FlightMax Entegra Primary Flight and Multi-Function Displays are installed per the Equipment List. The information contained herein supplements or supersedes the basic Pilot's Operating Handbook and FAA Approved Airplane Flight Manual only in those areas listed herein. For limitations, procedures and performance information not contained in this supplement, consult the Pilot's Operating Handbook and FAA Approved Airplane Flight Manual.

FAA APPROVED:



LINDA J. DICKEN  
DOA-510620-CE  
THE NEW PIPER AIRCRAFT, INC.  
VERO BEACH, FLORIDA

DATE OF APPROVAL: OCTOBER 7, 2004

ISSUED: JULY 12, 1995  
REVISED: JANUARY 9, 2006

REPORT: VB-1612  
1 of 30, 9-91 |

SECTION 1 - GENERAL

This airplane is equipped with the Avidyne FlightMax Entegra EXP5000 series 700-00006-0XX-( ) Primary Flight Display with software to the latest approved revision per Avidyne web site and EX5000 series 700-00004-0XX-( ) Multi-Function Display with software to the latest approved revision per Avidyne web site, herein referred to as the “PFD” and “MFD”. The PFD is intended to be the primary display of primary flight and essential engine parameter information to the pilot. The PFD is capable of interfacing with a pair of Garmin GNS 430/530’s, and an S-TEC System 55X autopilot.

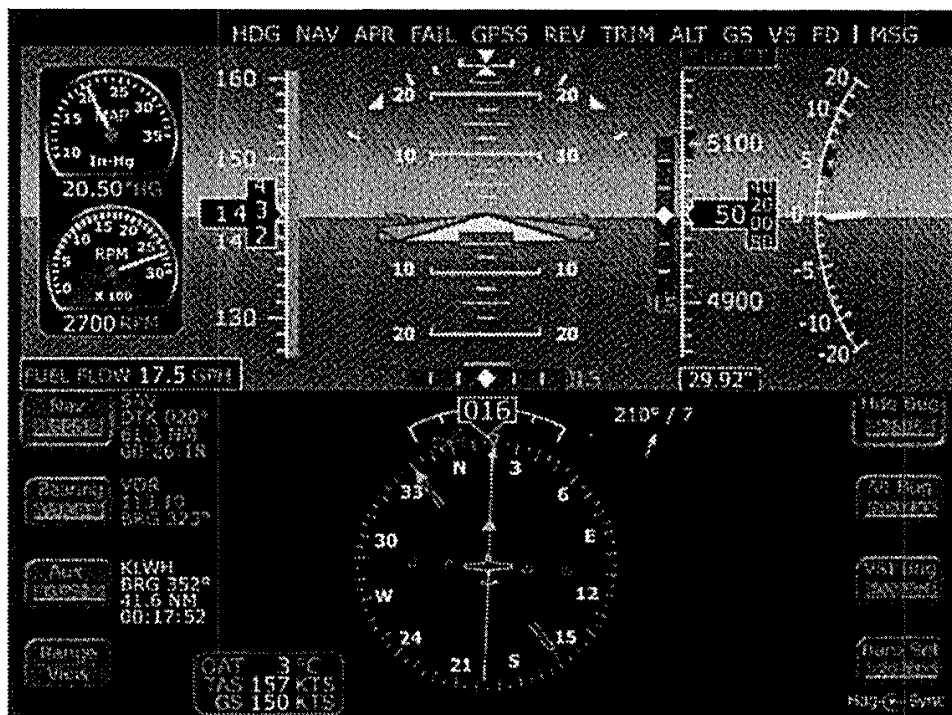

Figure 1 - Entegra 700-00006-0XX-( ) Primary Flight Display

The PFD provides the display of the following aircraft parameters:

- Artificial Horizon
- Airspeed Indication
- Altimeter
- Vertical Speed Indication
- Rate of Turn Indicator
- Skid/Slip Indicator
- Horizontal Situation Indication
- RMI
- Course Deviation Indication
- Outside Air Temperature
- Engine RPM
- Manifold Pressure
- Fuel Flow
- Oil Pressure
- Autopilot Annunciation

**SECTION 1 - GENERAL (continued)**

The MFD is intended to be a supplemental display of situational and navigation information to the pilot. Its primary function is to provide a moving map display to the pilot for increased situational awareness. The MFD is capable of accepting data from a variety of GPS sensors, the BFG WX-500 Stormscope passive thunderstorm detection unit, Engine Sensor Unit, and either the L3 Skywatch Traffic Advisory System (TAS), Bendix/King TAS, or the Ryan Traffic and Collision Alert Device (TCAD) system. The unit is organized around logical groupings of information presented on “Pages”.

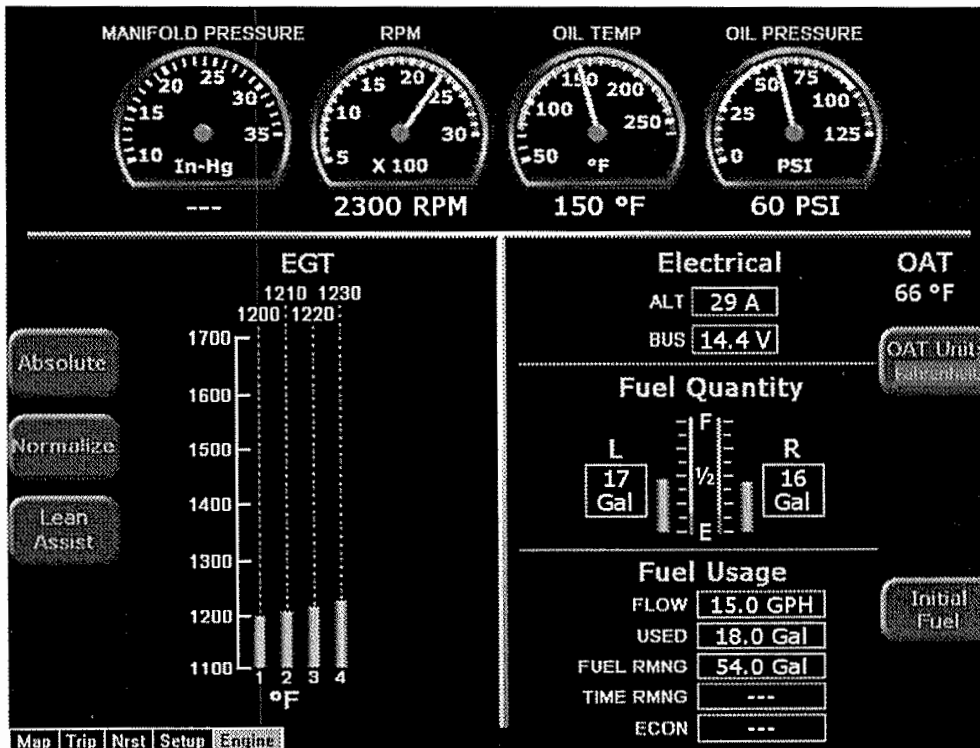

Figure 2 - EX5000 series 700-00004-0XX-( ) Multi-Function Display

The MFD provides the display of the following aircraft parameters:

- Manifold Pressure
- Engine RPM
- Engine Oil Temperature
- Engine Oil Pressure
- EGT
- Cylinder Head Temperature
- Aircraft Electrical Status
- Outside Air Temperature
- Fuel Quantity
- Fuel Usage Data

**SECTION 2 - LIMITATIONS**

**A. PFD Limitations**

1. IFR flight is prohibited when the PFD or any standby instrument is inoperative (altimeter, airspeed indicator, artificial horizon, or whiskey compass).
2. IFR flight is prohibited upon aircraft total loss of essential engine parameter display (manifold pressure, tachometer, fuel flow).
3. The Avidyne FlightMax Entegra series Primary Flight Display Pilot's Guide, p/n 600-00104-000 revision 00 or appropriate later revision, or p/n 600-00143-000 revision 01 (EXP 5000 R6) or appropriate later revision, must be available to the pilot during all flight operations.
4. If a VOR or Localizer (VLOC) navigation source is displayed on the HSI and GPSS mode is engaged on the autopilot, the autopilot will track the active flight plan in the GPS corresponding to the selected VLOC source selected for display on the HSI (i.e. GPS1 for VLOC1 or GPS2 for VLOC2). This configuration is potentially confusing and must be avoided.
5. GPSS mode must not be used on the final approach segment of a VLOC approach (ILS, LOC or non-GPS-overlay VOR). GPSS mode must be deselected (i.e., NAV mode selected) prior to the turn onto the final approach course.

**NOTE**

The PFD integrates with separately approved sensor and flight control installations. Adherence to limitations in appropriate installation AFM supplements is mandatory.

**B. MFD Limitations**

1. The Avidyne moving map display provides visual advisory of the airplane's GPS position against a moving map. This information supplements CDI course deviation and information presented on the GPS navigator. The moving map display must not be used as the primary navigation instrument.
2. Use of Map page during IFR flight requires an IFR approved GPS receiver and installation, operated in accordance with its applicable limitations.
3. The Avidyne FlightMax EX-series Pilot's Guide, p/n 600-00105-000 revision 00 or appropriate later revision, must be available to the pilot during all flight operations.

**SECTION 2 - LIMITATIONS (continued)****B. MFD Limitations (continued)**

4. Aircraft dispatch is prohibited when the MFD is inoperative.
5. Selecting "Lightning Display OFF" for the Lightning overlay of the Map page will prevent current heading values from being sent to the WX500 sensor from the EX5000.

When "Lightning Display OFF" is selected the EX5000 will stop sending current heading values to the WX500. When this selection is made, the WX500 will still use the last heading value that was present before this selection even though the actual aircraft heading may have changed since that selection was made.

Consequently, the Stormscope heading information provided to the Garmin 430 by the EX5000 will not be updated, resulting in an inaccurate lightning depiction on the Garmin 430. This issue does not affect the lightning display on the EX5000.

To avoid this invalid condition, **disable the WX500 on the GNS430**. For instructions on how to accomplish this, refer to the Garmin 400 Series Installation Manual, p/n 190-00140-02, latest revision (reference Section 5.1 Configuration Mode Operations, Section 5.2 Installation Configuration pages, and Section 5.2.2 Main RS232 Configuration page).

**CAUTION**

Traffic information shown on the Map page display is provided to the pilot as an aid to visually acquiring traffic. Pilot's should maneuver their aircraft based only on ATC guidance or positive visual acquisition of the conflicting traffic. Maneuvers should be consistent with ATC instructions. No maneuvers should be based only on a Traffic Advisory.

Terrain information shown on the Map page display is provided to the pilot as an aid to situational awareness. The Map page terrain color representations should not be used as a basis for terrain avoidance.

**NOTE**

The MFD integrates with separately approved sensor and flight control installations. Adherence to limitations in appropriate installation AFM supplements is mandatory.



**SECTION 2 - LIMITATIONS (continued)**

**C. CMAX CHART PAGE Limitations**

The geographic referenced aircraft symbol must not be used for navigation.

**NOTE**

The aircraft symbol displayed provides supplemental aircraft situational awareness information. It is not intended as a means for navigation or flight guidance. The airplane symbol is not to be used for conducting instrument approaches or departures. Position accuracy, orientation, and related guidance must be assumed by other means or required navigation.

Operators with the optional CMax Chart Page must have back-up charts available. Do not rely upon CMax charts as your sole source of navigation information.

**THIS PAGE INTENTIONALLY LEFT BLANK**

**SECTION 3 - EMERGENCY PROCEDURES**

**Failure of Pilot's Electronic Attitude Direction Display Screen (PFD)**

**Indication: PFD Display goes blank.**

Standby Attitude Gyro .....VERIFY ON and  
flag is pulled on gyro

Maintain attitude control using standby gyro and establish the aircraft in straight and level unaccelerated flight.

**If time and conditions permit:**

PFD Brightness Control (BRT/DIM) .....Run to full bright  
PFD Circuit Breaker .....PULL and RESET

*If PFD Screen cannot be reinstated:*

On aircraft equipped with the optional second Nav Indicator (OBS):

Mechanical Nav Indicator (OBS).....Utilize for primary navigation

Engine Instruments.....Refer to Engine page of MFD

**NOTE**

The Mechanical Nav Indicator (OBS) receives nav information directly from the No. 2 nav/com/GPS. Only VLOC information is available.

Maintain attitude, airspeed and heading control using standby instruments, magnetic compass and other directional indications (such as MFD, MAP/NAV page).

**CAUTION**

High current loads in the vicinity of the magnetic compass can influence its accuracy. Depending on the flight conditions, the pilot must reduce these loads as much as possible to insure accuracy. Tests have shown that air conditioner and pitot heat contribute to significant heading errors of the magnetic compass. These items should be turned OFF prior to comparing magnetic compass headings.

*Land as soon as practical.*

**SECTION 3 - EMERGENCY PROCEDURES (continued)**

**Loss of PFD Engine Data**

**Indication: Indicator needle removed from dial and digital readout replaced with white dashes.**

Engine Instruments.....Refer to Engine page of MFD

*Land as soon as practical.*

**Invalid Air Data**

**Indication: Airspeed, Altimeter, and Vertical Speed data replaced with Red X's.**

Maintain aircraft airspeed and altitude by referring to the standby airspeed and altimeter.

**If time and conditions permit:**

PFD Circuit Breaker .....PULL and RESET

**If air data is still invalid:**

Refer to standby airspeed indicator and altimeter.

*Land as soon as practical.*

**Invalid Heading Data**

**Indication: Heading Bug and Heading Data removed and replaced with Red X's.**

**If time and conditions permit:**

PFD Circuit Breaker .....PULL and RESET

Maintain heading control using magnetic compass and other directional indications (such as MFD, MAP/NAV page).

**CAUTION**

High current loads in the vicinity of the magnetic compass can influence its accuracy. Depending on the flight conditions, the pilot must reduce these loads as much as possible to insure accuracy. Tests have shown that air conditioner and pitot heat contribute to significant heading errors of the magnetic compass. These items should be turned OFF prior to comparing magnetic compass headings.

*Land as soon as practical.*

**SECTION 3 - EMERGENCY PROCEDURES (continued)**

**Invalid Attitude and Heading Data**

**Indication: Attitude and Heading Data removed and replaced with Red X's.**

Standby Attitude Gyro .....VERIFY ON and  
flag is pulled on gyro.

Maintain attitude control using standby gyro.

**If time and conditions permit:**

PFD Circuit Breaker .....PULL and RESET

**If attitude and heading data is still invalid:**

Maintain attitude control by using standby gyro.

Maintain heading control by utilizing magnetic compass and other directional indications (such as MFD, MAP/NAV page).

**CAUTION**

High current loads in the vicinity of the magnetic compass can influence its accuracy. Depending on the flight conditions, the pilot must reduce these loads as much as possible to insure accuracy. Tests have shown that air conditioner and pitot heat contribute to significant heading errors of the magnetic compass. These items should be turned OFF prior to comparing magnetic compass headings.

***Land as soon as practical.***

**SECTION 3 - EMERGENCY PROCEDURES (continued)**

**Failure of Attitude, Airspeed and Heading Reference System (ADAHRS)**

**Indication: Airspeed, Attitude, Heading and Altitude replaced with Red X's.**

Standby Attitude Gyro .....VERIFY ON and  
flag is pulled on gyro

Maintain attitude control using standby gyro.

**If time and conditions permit:**

PFD Circuit Breaker .....PULL and RESET

*If ADAHRS initialization does not occur:*

On aircraft equipped with the optional second Nav Indicator (OBS):

Mechanical Nav Indicator (OBS).....Utilize for primary navigation

Engine Instruments.....Refer to Engine page of MFD

**NOTE**

The Mechanical Nav Indicator (OBS) receives nav information directly from the No. 2 nav/com/GPS. Only VLOC information is available.

Maintain attitude, airspeed and heading control using standby instruments, magnetic compass and other directional indications (such as MFD, MAP/NAV page).

**CAUTION**

High current loads in the vicinity of the magnetic compass can influence its accuracy. Depending on the flight conditions, the pilot must reduce these loads as much as possible to insure accuracy. Tests have shown that air conditioner and pitot heat contribute to significant heading errors of the magnetic compass. These items should be turned OFF prior to comparing magnetic compass headings.

*Land as soon as practical.*

**SECTION 3 - EMERGENCY PROCEDURES (continued)**

**Cross Check Monitor**

**Indication: Yellow Crosscheck Attitude Annunciator on PFD.**

Establish aircraft in straight and level unaccelerated flight.

Aircraft Attitude .....Crosscheck aircraft attitude  
with standby attitude gyro

**Total Loss of Engine Instruments**

**Indication: Indicator needle removed from dial and digital readout replaced with white dashes.**

DAU Circuit Breaker .....PULL and RESET

**If engine data is still invalid:**

**NOTE**

The following engine messages will be displayed on the MFD if an exceedance is detected:

- Check Oil Temp
- Check Oil Press
- Check CHT
- Check RPM
- Check Manifold Pressure

*If failure occurs during takeoff:*

Mixture .....Maintain full rich  
 Propeller Control .....Full Forward  
 Manifold Pressure .....As required

***Return to airport for landing.***

*If failure occurs during climb or landing:*

Mixture .....Maintain full rich  
 Propeller Control .....Full Forward  
 Manifold Pressure .....As required

***Land as soon as practical.***

*If failure occurs after setting cruise power and mixture:*

Power .....Maintain power setting

***Land as soon as practical.***

*If failure occurs prior to or during descent:*

Manifold Pressure .....Set for descent  
 Mixture .....Full rich

**SECTION 3 - EMERGENCY PROCEDURES (continued)**

**Alternator Failure**

**Indication: Alternator Inop annunciator light illuminated and zero current displayed on MFD alternator indication source.**

**NOTE**

Anytime the bus voltage is below 25 Vdc, the Low Bus Voltage annunciator will be illuminated.

Verify Failure.....Check ammeter

**If ammeter shows zero:**

ALTR switch .....OFF

Reduce electrical load to minimum:

ALTNR FIELD C/B .....CHECK and RESET as required

ALTR Switch .....ON

**WARNING**

Compass error may exceed 10 degrees with alternator inoperative.

**CAUTION**

Any power interruption will result in loss of attitude information from the PFD until the unit can be reinstated on the ground.

**NOTE**

Consider using the autopilot to reduce workload. Using the GPSS mode can assist in maintaining a flight-planned route.

**NOTE**

LO BUS VOLTAGE annunciator will be illuminated. Anticipate complete electrical failure. Duration of battery power available will be dependent on electrical load and battery condition prior to failure.

**NOTE**

If the battery is depleted, the landing gear must be lowered using the emergency extension procedure. The gear position lights will be inoperative.



**SECTION 3 - EMERGENCY PROCEDURES (continued)**

**Alternator Failure (continued)**

**If power is not restored:**

ALTR Switch.....OFF

Reduce electrical loads by switching OFF or pulling circuit breakers for all non-essential equipment to include the following:

- Reduce PFD and MFD brightness as part of overall electrical system management
- Pitot heat (unless required)
- Airconditioner and ventilation fan (if installed)
- Landing light (use sparingly)
- Strobe lights
- Recognition lights (if equipped)
- Cabin/flood lights
- No. 2 nav/com/GPS
- Autopilot
- Electric trim
- DME (unless required for published approach)
- Stormscope (if equipped)
- Skywatch (if equipped)

*Land as soon as practical.*

**SECTION 3 - EMERGENCY PROCEDURES (continued)**

**Complete Electrical Failure**

Standby Attitude Gyro .....SELECT Standby (STBY) power button

**CAUTION**

The STBY PWR annunciator will rapidly flash for approximately one minute when aircraft power is lost. STBY PWR must be selected, otherwise the gyro will auto shutdown after approximately one minute.

Standby Attitude Gyro .....VERIFY ON and  
flag is pulled on gyro

Maintain aircraft control with reference to the standby airspeed, altimeter, and attitude gyro indicators.

Battery Switch .....OFF

Ground Clearance Switch (if installed) .....ON

*Land as soon as possible.*

**WARNING**

Compass error may exceed 10 degrees with alternator inoperative.

**NOTE**

Turning ON the ground clearance switch will activate the No. 1 nav/com/GPS radio.

**NOTE**

If the battery is depleted, the landing gear must be lowered using the emergency extension procedure. The gear position lights will be inoperative.

**SECTION 3 - EMERGENCY PROCEDURES (continued)**

**Fire in Flight**

**Electrical Fire**

Fire.....Extinguish  
Standby Attitude Gyro .....VERIFY ON and  
flag is pulled on gyro

Maintain aircraft control with reference to the standby airspeed, altimeter, and attitude gyro indicators.

Battery Master Switch.....OFF  
ALTR Switch.....OFF  
Ground Clearance Switch (if installed) .....ON

**NOTE**

Turning ON the ground clearance switch will activate the No. 1 nav/com/GPS radio.

Vents .....OPEN  
Cabin Heat .....OFF

**Land as soon as practical.**

**WARNING**

Compass error may exceed 10 degrees with alternator inoperative.

**NOTE**

If the battery is depleted, the landing gear must be lowered using the emergency extension procedure. The gear position lights will be inoperative.

**SECTION 3 - EMERGENCY PROCEDURES (continued)**

**Aircraft Engine Power Loss**

During an engine failure the pilot may elect to attempt an engine restart. During this time large voltage drops may cause the PFD to lose power and reinitialize. During this initialization process the PFD may not be able to complete a fast alignment during flight and therefore the pilot may have to obtain aircraft attitude and aircraft control using the standby instruments.

- Refer to the Emergency Section of the Pilot’s Operating Handbook.
- If the PFD is able to perform fast alignment, when prompted by the PFD:
  - Maintain straight and level flight
- OR**
- If engine does not restart, maintain wings level and appropriate aircraft speed.
- Press the fast erect button.
- If the PFD was not able to perform fast alignment, maintain aircraft control with reference to the standby instruments for aircraft attitude information.

**CAUTION**

In case of engine failure, minimize the use of the starter and turn off all non-essential electrical equipment to preserve battery capacity.

**Loss of Fuel Flow**

Electric Fuel Pump .....ON  
 Fuel Selector .....Check on tank containing usable fuel

**Engine Driven Fuel Pump Failure**

Throttle .....RETARD  
 Electric Fuel Pump .....ON  
 Throttle.....RESET as required

**CAUTION**

If normal engine operation and fuel flow is not immediately re-established, the electric fuel pump should be turned OFF. The lack of fuel flow indication while the electric pump is on could indicate a leak in the fuel system or fuel exhaustion. If fuel system leak is verified, switch fuel selector to OFF.

---

**SECTION 3 - EMERGENCY PROCEDURES (continued)**

**Loss of Heading Accuracy**

Indication:

- Difficulty maintaining course while using VOR or GPS.
- Excessive difference between heading and track required maintaining a VOR or GPS course.
- ATC indicates the aircraft is on a wrong heading.
- Excessive deviation between PFD heading and Whiskey Compass. (>10° after compass deviation applied.)

If heading systems differ by more than 10° (after compass deviation applied):

- Use Whiskey Compass for primary heading reference.

***CAUTION***

High current loads in the vicinity of the Whiskey Compass can influence its accuracy. Depending on the flight conditions, the pilot must reduce these loads as much as possible to insure accuracy. Tests have shown that air conditioner and pitot heat contribute to significant heading errors of the Whiskey Compass. These items should be turned OFF prior to comparing the Whiskey Compass to the PDF heading.

**SECTION 4 - NORMAL PROCEDURES**

**Engine Start - General**

**CAUTION**

Do not attempt flight if there is no indication of alternator output.

**CAUTION**

If a positive oil pressure is not indicated within 30 seconds following an engine start, stop the engine and determine the trouble. In cold weather it will take a few seconds longer to get a positive oil pressure indication.

**NOTE**

Starter manufacturer recommends starter cranking periods be limited to 10 seconds with a 20 second rest period between cranking attempts. Maximum of 6 start periods allowed. If start is not achieved on sixth attempt allow starter to cool for 30 minutes before attempting additional starts.

**Before Starting Engine**

- Passengers .....BOARD
- Door .....CLOSE and LATCH
- Seats .....ADJUSTED and LOCKED in position
- Seat Belts and Harnesses .....FASTEN/ADJUST
- Brakes .....SET
- Circuit Breakers.....Check IN
- Alternate Air .....OFF
- Propeller .....Full INCREASE rpm
- Fuel Selector.....Desired tank

**SECTION 4 - NORMAL PROCEDURES (continued)**

**Normal Start - Cold Engine**

Throttle .....½ inch open  
Battery Master Switch.....ON  
Primary Flight Display (PFD) .....Verify correct aircraft  
model software  
Alternator Switch .....ON  
Electric Fuel Pump .....ON  
Mixture.....Prime - then idle cut-off  
Propeller.....CLEAR  
Starter .....ENGAGE  
Mixture.....Full RICH  
Throttle.....ADJUST  
Oil Pressure .....CHECK

**Normal Start - Hot Engine**

Throttle .....½ inch open  
Battery Master Switch.....ON  
Primary Flight Display (PFD) .....Verify correct aircraft  
model software  
Alternator Switch .....ON  
Electric Fuel Pump .....ON  
Mixture .....Idle cut-off  
Propeller.....CLEAR  
Starter .....ENGAGE  
Mixture.....ADVANCE  
Throttle.....ADJUST  
Oil Pressure .....CHECK

**SECTION 4 - NORMAL PROCEDURES (continued)**

**Engine Start When Flooded**

- Throttle .....Open full
- Battery Master Switch.....ON
- Primary Flight Display (PFD) .....Verify correct aircraft  
model software
  
- Alternator Switch .....ON
- Electric Fuel Pump .....OFF
- Mixture .....Idle cut-off
- Propeller.....CLEAR
- Starter .....ENGAGE
- Mixture .....Full rich
- Throttle .....RETARD
- Oil Pressure .....CHECK



**SECTION 4 - NORMAL PROCEDURES (continued)**

**Starting With External Power Source**

**CAUTION**

It is possible to use the ship's battery in parallel by turning only the battery master switch ON. This will give longer cranking capabilities, but will not increase the amperage. Care should be exercised because if the ship's battery has been depleted, the external power supply can be reduced to the level of the ship's battery. This can be tested by turning on the battery master switch momentarily while the starter is engaged. If cranking speed increases, the ship's battery is at a higher level than the external power supply.

**NOTE**

For all normal operations using external power, the battery master and alternator switches should be OFF.

- Battery Master Switch .....OFF
- Alternator Switch.....OFF
- All Electrical Equipment .....OFF
- External Power Plug .....Insert in fuselage
- Proceed with normal start checklist
- Throttle .....Lowest possible RPM
- External Power Plug .....Disconnect from fuselage
- Battery Master Switch.....ON
- Alternator Switch .....ON - check ammeter
- Oil Pressure .....CHECK

**SECTION 5 - PERFORMANCE**

No change from basic Handbook.

**SECTION 6 - WEIGHT AND BALANCE**

No change from basic Handbook.

**SECTION 7 - DESCRIPTION AND OPERATION****A. PFD Systems Description****NOTE**

This supplement provides a general description of the Avidyne FlightMax Entegra Series 700-00006-0XX-( ) PFD, its operation, and aircraft systems interfaces. For a detailed description of PFD operation, refer to the Avidyne FlightMax Entegra Series Primary Flight Display Pilot's Guide, p/n 600-00104-000 revision 00 or appropriate later revision, or 600-00143-000 revision 01 (EXP 5000 R6) or appropriate later revision.

The Entegra PFD start-up is automatic once power is applied. The display presents the Initialization Display immediately after power is applied. Power-on default is 75% brightness. Typical alignment times are 3 minutes once power is applied.

**Attitude Direction Indicator (ADI)**Air Data

The airspeed tape to the left of the main ADI begins indicating at 20 Knots Indicated Airspeed (IAS) and is color coded in accordance with the model POH airspeeds for  $V_{SO}$ ,  $V_{FE}$ ,  $V_S$ ,  $V_{NO}$ , and  $V_{NE}$ . An altitude tape is provided to the right of the main ADI and also displays a symbol for the Altitude Preselect (Altitude Bug). The Vertical Speed Indicator (VSI) is displayed to the right of the altitude tape. For vertical speed rates greater than the PFD displayed VSI scale, the indicator needle will peg just outside the scale and a digital readout of actual VSI up to 4000 FPM is then displayed. An additional data block is provided for display of Outside Air Temperature (OAT), True Airspeed (TAS), and Ground Speed (GS). Controls for selecting bug and barometric correction values are along the right side of the PFD. A wind indicator is also provided beneath the altitude tape.

Attitude Data

Attitude is depicted on the main ADI using a combination of an aircraft reference symbol ("flying-delta") against a background of labeled pitch ladders for pitch and a bank angle pointer in the form of an arced scale along the top of the main ADI for bank. A skid/slip indicator is attached to the bottom edge of the bank angle pointer.

**ISSUED: JULY 12, 1995**  
**REVISED: APRIL 11, 2006**

**REPORT: VB-1612**  
**23 of 30, 9-111**

**SECTION 7 - DESCRIPTION AND OPERATION (continued)**

**A. PFD Systems Description (continued)**

**Horizontal Situation Indicator (HSI)**

Heading Data

Magnetic heading is represented in a boxed digital form at the top of the compass rose. Heading rate (Rate of Turn Indicator) takes the form of a blue arcing arrow that begins behind the magnetic heading indicator and moves left or right accordingly. Graduations are provided on the rate of turn indicator scale to indicate 1/2 and full standard rate turns. A heading bug is also provided on the compass rose.

Navigation Data

Navigation data on the PFD takes several forms. A Course Deviation Indicator (CDI) is always provided on the HSI and a bearing pointer can be optionally selected for display on the HSI by the pilot. Controls for selecting the source of navigation data, selecting the display format of the navigation data, and for selecting the type of compass rose and moving map to be displayed are along the left side of the PFD. The active flight plan contained in the GPS Nav/Comm unit selected as the primary navigation source (Nav) can be optionally selected for display on the HSI as well as the desired range of the optionally selectable moving map display. If a localizer or ILS frequency is tuned and captured in the GPS Nav/Comm selected as the Nav source, a Vertical Deviation Indicator (VDI) and Horizontal Deviation Indicator (HDI) are automatically displayed on the ADI.

While executing an ILS or localizer only approach, the course deviation indicator (CDI) and glideslope needles on the PFD, as appropriate, may exhibit a slight oscillatory motion. The oscillatory motion increases from zero amplitude at approximately 2500 rpm to approximately 1/2 dot total amplitude at 2700 rpm. The GI-106 mechanical VOR Indicator needles exhibit this same behavior, only to a lesser degree. The pilot should fly the "average" localizer/glideslope needle position or decrease engine rpm to reduce needle oscillation.

**NOTE**

In the event glide slope or localizer signals are lost, the HDI and/or VDI will be displayed as red X's to indicate loss of signal. The red X'd indicator will only be removed if the signal is regained. In this case, the PFD Nav source will set to GPS, or if the GPS Nav/Comm is retuned, to another frequency. Appropriate action must be taken by the pilot if on an approach.

**SECTION 7 - DESCRIPTION AND OPERATION (continued)****A. PFD Systems Description (continued)****Autopilot Integration**

The Entegra PFD is fully integrated with the S-TEC System 55X Autopilot. Reference bugs for Heading, Altitude, and Vertical Speed are provided on the PFD to control the autopilot and aid pilot situational awareness. These bugs are displayed with solid or hollow symbology depending on the autopilot status. If the autopilot is engaged in that mode, the bug is solid to indicate the autopilot is coupled to that bug. A hollow bug indicates the autopilot is not engaged in that mode.

Autopilot mode annunciations are shown on the S-TEC System 55X computer.

When included as part of the installation, autopilot mode annunciations including autopilot ready and fail indications are provided at the top of the PFD screen.

When included as part of the installation, flight director command bars on the PFD attitude indicator can be enabled by the pilot. When the flight director is enabled and the autopilot is engaged in both lateral and vertical modes, the flight director displays the goals of the autopilot.

A lateral autopilot mode must be engaged on the S-TEC System 55X before a vertical mode can be engaged.

The flight director command bars will only be displayed on the PFD when enabled by the pilot and when both lateral and vertical autopilot modes are engaged.

**SECTION 7 - DESCRIPTION AND OPERATION (continued)**

**A. PFD Systems Description (continued)**

**Autopilot Integration (continued)**

The following autopilot modes are supported by the PFD:

1. HDG (Heading, using the heading bug)
2. NAV (Nav, using the course pointer and course deviation indicator)
3. GPSS (GPS Steering, using GPS course guidance)
4. APR (Approach, using the HDI and VDI, including automatic glide slope capture)
5. REV (Reverse sensing HDI approach)
6. ALT (Altitude Hold and Preselect, using the altitude bug)
7. VS (Vertical Speed, using the vertical speed bug)

**NOTE**

When HDG mode is engaged, rotation of the heading bug greater than 180° will result in a reversal of turn direction.

**CAUTION**

If a VLOC is selected in NAV on the PFD and GPSS mode is engaged on the autopilot, the autopilot will track the active flight plan in GPS1 if VLOC1 is selected or GPS2 if VLOC2 is selected and not track VLOC1 or VLOC2 as the selected source in NAV on the PFD. Therefore, the course deviation on the PFD CDI and the course deviation flown by the autopilot can be different. This situation may be confusing and should be avoided.

**Engine Instruments**

The Entegra PFD provides a display of Engine Tachometer (RPM), Manifold Pressure (MAP), Oil Pressure (OP), and Fuel Flow (FF) in the upper left hand corner of the display. Tach and MAP indications are presented on analog scales with normal operating (green) and warning (red) markings, as appropriate. A digital indication presents fuel flow information in gallons per hour (GPH). A digital indication presents oil pressure information in pounds per square inch (PSI).

**SECTION 7 - DESCRIPTION AND OPERATION (continued)****A. PFD Systems Description (continued)****Back-up Instruments**

The Entegra PFD system installation includes redundant means of display of certain aircraft flight and systems parameters. Back-up Altimeter, Airspeed and Attitude instruments are provided to facilitate pilot cross-checking of PFD display flight parameters. The aircraft wet compass serves as a back-up heading source.

**THIS SPACE INTENTIONALLY LEFT BLANK**

**ISSUED: JULY 12, 1995**  
**REVISED: JANUARY 9, 2006**

**REPORT: VB-1612**  
**27 of 30, 9-115 |**

**SECTION 7 - DESCRIPTION AND OPERATION (continued)**

**B. MFD Systems Description**

**NOTE**

This supplement provides a general description of the Avidyne EX5000 Series 700-00004-0XX-( ) MFD, its operation and aircraft interface. For a detailed description of the MFD, refer to the Avidyne FlightMax EX5000 Series Pilot's Guide and Reference, p/n 600-00105-000 revision 00 or later.

**Navigation**

Data associated with the moving map is found on four pages: Map, Nearest, Trip, and Info pages. The MFD contains a Jeppesen NavData database that is available for display on the Map page. In conjunction with GPS-supplied position information, an own-ship symbol is superimposed on the moving map and positioned relative to the NavData information. GPS can also supply the active flight plan for display on the moving map. Terrain data is provided by a USGS terrain database stored within the MFD and updated only on an as needed basis.

The Jeppesen Navigation Database provides data on airports, approaches, VOR's, NDB's, intersections, airspace definitions, and frequencies. North American and international databases are available. Database information can be updated via the USB port on the front face of the bezel.

The navigation data on the moving map display are based on databases that are updated periodically. Database updates are available on 28-day cycle subscriptions. Expired databases are clearly stated to the pilot via messages during system startup and on the System Setup page. The warning can only be removed by updating the data.

NOAA man-made obstruction database information provides data on man-made obstacles over 200 feet AGL. This data is only available for North America and can be updated via the USB port on the front face of the bezel.

The obstacle data on the moving map display are based on databases that are updated periodically. Database updates are available from Avidyne on 56-day cycle subscriptions. Expired databases are clearly stated to the pilot via messages during system startup and on the System Setup page. The warning can only be removed by updating the data.

**SECTION 7 - DESCRIPTION AND OPERATION (continued)****B. MFD Systems Description (continued)****Navigation (continued)**

Using the Jeppesen NavData data and the GPS-supplied present position, the MFD can provide the pilot with the nearest 25 airports or navaids, depending on pilot selection, within 100 nm. This information is presented on the Nearest page.

More detailed information on a particular airport is also generated from the Jeppesen NavData data and is available for pilot viewing on the Info page.

Flight plan data supplied by the GPS system provide the pilot with a tabular form of the remaining legs in the active GPS flight plan. This information is viewed on the Trip page and includes a CDI for added enroute navigation aiding.

Flight plan data is transmitted to the MFD from an external GPS navigator. Some installations do not support depictions of curved flight paths. In these cases, curved flight path segments will be depicted as straight lines. The GPS navigator and HSI are to be used during approach procedures. Reference the Avidyne FlightMax EX5000 Series Pilot's Guide, p/n 600-00105-000, for more information.

**Datalink**

Datalink information is received by the MFD based upon installation provisions and a subscription service available through Avidyne ([www.myavidyne.com](http://www.myavidyne.com)). Data is presented on the Map, Trip, and Nearest pages. Datalink information is provided for strategic planning purposes only. Data aging and transport considerations make it unsuitable for tactical use. Reference the Avidyne FlightMax EX5000 Series Pilot's Guide, p/n 600-00105-000, for more information.

**Setup**

The various System Setup pages allow the pilot to set user preferences for system operation. In addition to listing the software version identification information and database validity dates, the System Setup page allows access to several pages for preference selection and provides a means to initiate self-tests of the traffic and lightning sensors.



## SECTION 7 - DESCRIPTION AND OPERATION (continued)

### B. MFD Systems Description (continued)

#### Setup (continued)

**Airport Settings** page provides selections for displaying airport type, runway surface type and minimum runway lengths on the moving map. **Declutter Settings** page allows the pilot to select settings for defining the base map detail when changing display range. **System Time** page provides an opportunity to select system time zone and Map page menu timeout options. **DataBlock Edit** page allows the pilot to select the data to be displayed in the datablock windows on the Map page. **Datalink Setup** page allows the pilot to select parameters for the datalink system, including update rate and range of weather data request.

#### Engine Instruments

The Engine page provides the pilot with engine parameters depicted on simulated gauges and electrical system parameters located in dedicated regions within the MFD display. An Engine Sensor Unit interfaces with engine-mounted sensors and provides data to the MFD for display.

A leaning function assists the pilot in leaning the engine for best power or best fuel economy. To initiate the leaning function, press the Lean Assist bezel key and proceed to lean the engine fuel mixture. Best economy is achieved when the engine is operating at peak EGT of the leanest cylinder (first cylinder to peak), as recommended by the engine manufacturer. Best power is achieved when the engine is leaned to the first cylinder to reach its EGT peak. When leaning is complete, select Absolute or Normalize to complete the leaning process. A digital readout of EGT change from the peak value is provided for reference. Reference the Avidyne FlightMax EX5000 series Pilot's Guide, p/n 600-00105-000, for more information.

### C. Electrical System

An optional heated pitot head, which alleviates problems with icing or heavy rain, is available. With the selection of pitot heat, an interlock will disable the air conditioner and/or cabin fan, which will prevent the possibility of exceeding the capability of the alternator. Monitor charge and voltage of the aircraft electrical system and consider discontinuing the use of other non-essential loads not required for the phase of flight.

Item currenty missing

**PILOT'S OPERATING HANDBOOK  
AND  
FAA APPROVED AIRPLANE FLIGHT MANUAL**

**SUPPLEMENT NO. 18  
FOR  
AVIDYNE FLIGHTMAX ENTEGRA  
PRIMARY FLIGHT/MULTI-FUNCTION DISPLAYS  
WITH  
THE B&C SPECIALTIES BC410 STANDBY ALTERNATOR**

This supplement must be attached to the Pilot's Operating Handbook and FAA Approved Airplane Flight Manual when the optional Avidyne FlightMax Entegra Primary Flight and Multi-Function Displays with the B&C Specialties BC410 Standby Alternator is installed per the Equipment List. The information contained herein supplements or supersedes the basic Pilot's Operating Handbook and FAA Approved Airplane Flight Manual only in those areas listed herein. For limitations, procedures and performance information not contained in this supplement, consult the Pilot's Operating Handbook and FAA Approved Airplane Flight Manual.

FAA APPROVED:



LINDA J. DICKEN  
DOA-510620-CE  
THE NEW PIPER AIRCRAFT, INC.  
VERO BEACH, FLORIDA

DATE OF APPROVAL:   MAY 22, 2006  

ISSUED: JULY 12, 1995  
REVISED: MAY 22, 2006

REPORT: VB-1612 |  
1 of 36, 9-123 |

SECTION 1 - GENERAL

This airplane is equipped with the Avidyne FlightMax Entegra EXP5000 series 700-00006-0XX-( ) Primary Flight Display with software to the latest approved revision per Avidyne web site and EX5000 series 700-00004-0XX-( ) Multi-Function Display with software to the latest approved revision per Avidyne web site, herein referred to as the “PFD” and “MFD”. The PFD is intended to be the primary display of primary flight and essential engine parameter information to the pilot. The PFD is capable of interfacing with a pair of Garmin GNS 430/530’s, and an S-TEC System 55X autopilot.



Figure 1 - Entegra 700-00006-0XX-( ) Primary Flight Display

The PFD provides the display of the following aircraft parameters:

- Artificial Horizon
- Airspeed Indication
- Altimeter
- Vertical Speed Indication
- Rate of Turn Indicator
- Skid/Slip Indicator
- Horizontal Situation Indication
- RMI
- Course Deviation Indication
- Outside Air Temperature
- Engine RPM
- Manifold Pressure
- Fuel Flow
- Oil Pressure
- Autopilot Annunciation

## SECTION 1 - GENERAL (continued)

The MFD is intended to be a supplemental display of situational and navigation information to the pilot. Its primary function is to provide a moving map display to the pilot for increased situational awareness. The MFD is capable of accepting data from a variety of GPS sensors, the BFG WX-500 Stormscope passive thunderstorm detection unit, Engine Sensor Unit, and either the L3 Skywatch Traffic Advisory System (TAS), Bendix/King TAS, or the Ryan Traffic and Collision Alert Device (TCAD) system. The unit is organized around logical groupings of information presented on "Pages".

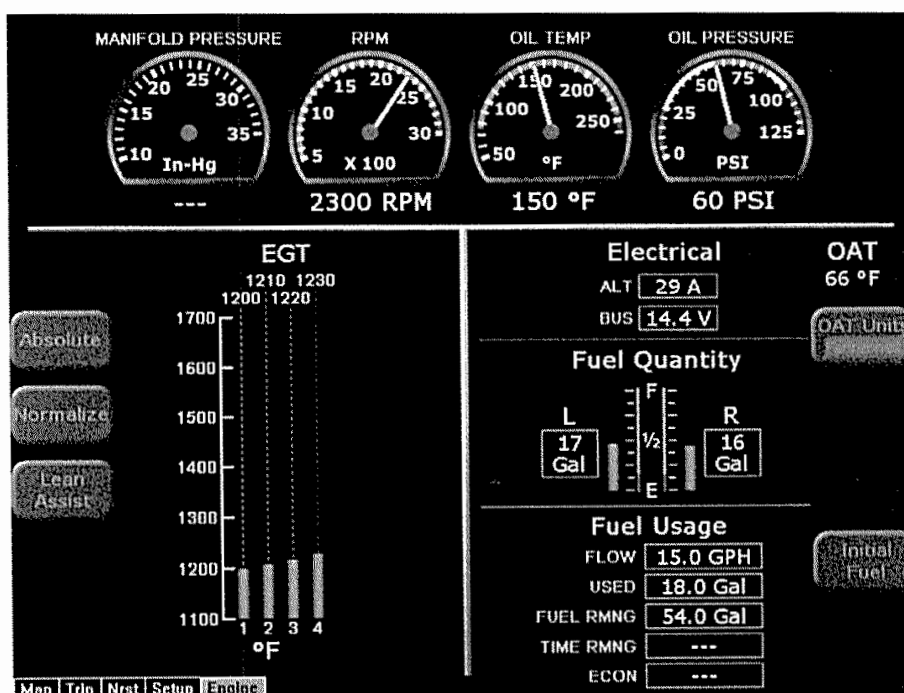

Figure 2 - EX5000 series 700-00004-0XX-( ) Multi-Function Display

The MFD provides the display of the following aircraft parameters:

- Manifold Pressure
- Engine RPM
- Engine Oil Temperature
- Engine Oil Pressure
- EGT
- Aircraft Electrical Status
- Outside Air Temperature
- Fuel Quantity
- Fuel Usage Data

**SECTION 1 - GENERAL (continued)**

A B&C Specialties, BC410 standby alternator, when ON, will replace the primary alternator function, but will not supplement its output. The alternator is gear driven through the engine vacuum pump drive pad.

The standby alternator is rated for 20 amperes of maximum load. The actual load available for use is dependent on engine rpm and current operating conditions.

**SECTION 2 - LIMITATIONS****A. PFD Limitations**

1. IFR flight is prohibited when the PFD or any standby instrument is inoperative (altimeter, airspeed indicator, artificial horizon, or whiskey compass).
2. IFR flight is prohibited upon aircraft total loss of essential engine parameter display (manifold pressure, tachometer, fuel flow).
3. The Avidyne FlightMax Entegra series Primary Flight Display Pilot's Guide, p/n 600-00104-000 revision 00 or appropriate later revision, or p/n 600-00143-000 revision 01 (EXP 5000 R6) or appropriate later revision, must be available to the pilot during all flight operations.
4. If a VOR or Localizer (VLOC) navigation source is displayed on the HSI and GPSS mode is engaged on the autopilot, the autopilot will track the active flight plan in the GPS corresponding to the selected VLOC source selected for display on the HSI (i.e. GPS1 for VLOC1 or GPS2 for VLOC2). This configuration is potentially confusing and must be avoided.
5. GPSS mode must not be used on the final approach segment of a VLOC approach (ILS, LOC or non-GPS-overlay VOR). GPSS mode must be deselected (i.e., NAV mode selected) prior to the turn onto the final approach course.

**NOTE**

The PFD integrates with separately approved sensor and flight control installations. Adherence to limitations in appropriate installation AFM supplements is mandatory.

**B. MFD Limitations**

1. The Avidyne moving map display provides visual advisory of the airplane's GPS position against a moving map. This information supplements CDI course deviation and information presented on the GPS navigator. The moving map display must not be used as the primary navigation instrument.
2. Use of Map page during IFR flight requires an IFR approved GPS receiver and installation, operated in accordance with its applicable limitations.
3. The Avidyne FlightMax EX-series Pilot's Guide, p/n 600-00105-000 revision 00 or appropriate later revision, must be available to the pilot during all flight operations.

**SECTION 2 - LIMITATIONS (continued)**

**B. MFD Limitations (continued)**

4. Aircraft dispatch is prohibited when the MFD is inoperative.
5. Selecting "Lightning Display OFF" for the Lightning overlay of the Map page will prevent current heading values from being sent to the WX500 sensor from the EX5000.

When "Lightning Display OFF" is selected the EX5000 will stop sending current heading values to the WX500. When this selection is made, the WX500 will still use the last heading value that was present before this selection even though the actual aircraft heading may have changed since that selection was made.

Consequently, the Stormscope heading information provided to the Garmin 430 by the EX5000 will not be updated, resulting in an inaccurate lightning depiction on the Garmin 430. This issue does not affect the lightning display on the EX5000.

To avoid this invalid condition, **disable the WX500 on the GNS430**. For instructions on how to accomplish this, refer to the Garmin 400 Series Installation Manual, p/n 190-00140-02, latest revision (reference Section 5.1 Configuration Mode Operations, Section 5.2 Installation Configuration pages, and Section 5.2.2 Main RS232 Configuration page).

**CAUTION**

Traffic information shown on the Map page display is provided to the pilot as an aid to visually acquiring traffic. Pilot's should maneuver their aircraft based only on ATC guidance or positive visual acquisition of the conflicting traffic. Maneuvers should be consistent with ATC instructions. No maneuvers should be based only on a Traffic Advisory.

Terrain information shown on the Map page display is provided to the pilot as an aid to situational awareness. The Map page terrain color representations should not be used as a basis for terrain avoidance.

**NOTE**

The MFD integrates with separately approved sensor and flight control installations. Adherence to limitations in appropriate installation AFM supplements is mandatory.



**SECTION 2 - LIMITATIONS (continued)****C. CMAX CHART PAGE Limitations**

The geographic referenced aircraft symbol must not be used for navigation.

**NOTE**

The aircraft symbol displayed provides supplemental aircraft situational awareness information. It is not intended as a means for navigation or flight guidance. The airplane symbol is not to be used for conducting instrument approaches or departures. Position accuracy, orientation, and related guidance must be assumed by other means or required navigation.

Operators with the optional CMax Chart Page must have back-up charts available. Do not rely upon CMax charts as your sole source of navigation information.

**D. STANDBY ALTERNATOR Limitations**

The standby alternator system is used in the event of primary alternator failure and not for normal operations.

The standby alternator is limited to 20 amperes continuous output. Transient operations of greater than 20 amperes for no more than 5 consecutive minutes may be conducted.

**SECTION 3 - EMERGENCY PROCEDURES**

**Failure of Pilot's Electronic Attitude Direction Display Screen (PFD)**

**Indication: PFD Display goes blank.**

Standby Attitude Gyro .....VERIFY ON and  
flag is pulled on gyro

Maintain attitude control using standby gyro and establish the aircraft in straight  
and level unaccelerated flight.

**If time and conditions permit:**

PFD Brightness Control (BRT/DIM) .....Run to full bright

PFD Circuit Breaker .....PULL and RESET

*If PFD Screen cannot be reinstated:*

On aircraft equipped with the optional second Nav Indicator (OBS):

Mechanical Nav Indicator (OBS).....Utilize for primary navigation

Engine Instruments.....Refer to Engine page of MFD

**NOTE**

The Mechanical Nav Indicator (OBS) receives nav  
information directly from the No. 2 nav/com/GPS. Only  
VLOC information is available.

Maintain attitude, airspeed and heading control using standby instruments,  
magnetic compass and other directional indications (such as MFD, MAP/NAV  
page).

**CAUTION**

High current loads in the vicinity of the magnetic compass  
can influence its accuracy. Depending on the flight conditions,  
the pilot must reduce these loads as much as possible to  
insure accuracy. Tests have shown that air conditioner and  
pitot heat contribute to significant heading errors of the  
magnetic compass. These items should be turned OFF prior  
to comparing magnetic compass headings.

*Land as soon as practical.*

**SECTION 3 - EMERGENCY PROCEDURES (continued)**

**Loss of PFD Engine Data**

**Indication:** Indicator needle removed from dial and digital readout replaced with white dashes.

Engine Instruments.....Refer to Engine page of MFD

*Land as soon as practical.*

**Invalid Air Data**

**Indication:** Airspeed, Altimeter, and Vertical Speed data replaced with Red X's.

Maintain aircraft airspeed and altitude by referring to the standby airspeed and altimeter.

**If time and conditions permit:**

PFD Circuit Breaker .....PULL and RESET

**If air data is still invalid:**

Refer to standby airspeed indicator and altimeter.

*Land as soon as practical.*

**Invalid Heading Data**

**Indication:** Heading Bug and Heading Data removed and replaced with Red X's.

**If time and conditions permit:**

PFD Circuit Breaker .....PULL and RESET

Maintain heading control using magnetic compass and other directional indications (such as MFD, MAP/NAV page).

**CAUTION**

High current loads in the vicinity of the magnetic compass can influence its accuracy. Depending on the flight conditions, the pilot must reduce these loads as much as possible to insure accuracy. Tests have shown that air conditioner and pitot heat contribute to significant heading errors of the magnetic compass. These items should be turned OFF prior to comparing magnetic compass headings.

*Land as soon as practical.*

**SECTION 3 - EMERGENCY PROCEDURES (continued)**

**Invalid Attitude and Heading Data**

**Indication: Attitude and Heading Data removed and replaced with Red X's.**

Standby Attitude Gyro .....VERIFY ON and  
flag is pulled on gyro.

Maintain attitude control using standby gyro.

**If time and conditions permit:**

PFD Circuit Breaker .....PULL and RESET

**If attitude and heading data is still invalid:**

Maintain attitude control by using standby gyro.

Maintain heading control by utilizing magnetic compass and other directional indications (such as MFD, MAP/NAV page).

**CAUTION**

High current loads in the vicinity of the magnetic compass can influence its accuracy. Depending on the flight conditions, the pilot must reduce these loads as much as possible to insure accuracy. Tests have shown that air conditioner and pitot heat contribute to significant heading errors of the magnetic compass. These items should be turned OFF prior to comparing magnetic compass headings.

*Land as soon as practical.*

**SECTION 3 - EMERGENCY PROCEDURES (continued)**

**Failure of Attitude, Airspeed and Heading Reference System (ADAHRS)**

**Indication: Airspeed, Attitude, Heading and Altitude replaced with Red X's.**

Standby Attitude Gyro .....VERIFY ON and  
flag is pulled on gyro

Maintain attitude control using standby gyro.

**If time and conditions permit:**

PFD Circuit Breaker .....PULL and RESET

*If ADAHRS initialization does not occur:*

On aircraft equipped with the optional second Nav Indicator (OBS):

Mechanical Nav Indicator (OBS).....Utilize for primary navigation

Engine Instruments.....Refer to Engine page of MFD

**NOTE**

The Mechanical Nav Indicator (OBS) receives nav information directly from the No. 2 nav/com/GPS. Only VLOC information is available.

Maintain attitude, airspeed and heading control using standby instruments, magnetic compass and other directional indications (such as MFD, MAP/NAV page).

**CAUTION**

High current loads in the vicinity of the magnetic compass can influence its accuracy. Depending on the flight conditions, the pilot must reduce these loads as much as possible to insure accuracy. Tests have shown that air conditioner and pitot heat contribute to significant heading errors of the magnetic compass. These items should be turned OFF prior to comparing magnetic compass headings.

*Land as soon as practical.*

**SECTION 3 - EMERGENCY PROCEDURES (continued)**

**Cross Check Monitor**

**Indication: Yellow Crosscheck Attitude Annunciator on PFD.**

Establish aircraft in straight and level unaccelerated flight.

Aircraft Attitude .....Crosscheck aircraft attitude  
with standby attitude gyro

**Total Loss of Engine Instruments**

**Indication: Indicator needle removed from dial and digital readout  
replaced with white dashes.**

DAU Circuit Breaker .....PULL and RESET

**If engine data is still invalid:**

**NOTE**

The following engine messages will be displayed on the  
MFD if an exceedance is detected:

- Check Oil Temp
- Check Oil Press
- Check RPM
- Check EGT
- Check Manifold Pressure

*If failure occurs during takeoff:*

Mixture .....Maintain full rich  
 Propeller Control .....Full forward  
 Manifold Pressure .....As required

***Return to airport for landing.***

*If failure occurs during climb or landing:*

Mixture .....Maintain full rich  
 Propeller Control .....Full forward  
 Manifold Pressure .....As required

***Land as soon as practical.***

*If failure occurs after setting cruise power and mixture:*

Power .....Maintain power setting

***Land as soon as practical.***

*If failure occurs prior to or during descent:*

Manifold Pressure .....Maintain 1000 ft/min descent at 146 KIAS  
 Mixture .....Full rich

**SECTION 3 - EMERGENCY PROCEDURES (continued)**

**ALTERNATOR FAILURE**

**Failure of Primary Alternator**

**Indication: Alternator Inop annunciator light illuminated and zero current displayed on MFD alternator indication source.**

**WARNING**

Compass error may exceed 10 degrees with alternator inoperative.

**CAUTION**

A power interruption greater than 20 seconds will result in loss of attitude information from the PFD until the unit can be reinstated on the ground.

**NOTE**

Anytime the bus voltage is below 12.5 Vdc, the LO BUS VOLTAGE annunciator will be illuminated.

- STBY ALTR .....Select ON/check ammeter indication
- Engine RPM .....Increase to a minimum of 2500
- Electrical Load .....Reduce until total load is below 20 amps

**NOTE**

If the STBY ALTR ON annunciator is flashing then reduce electrical loads until the annunciator no longer flashes.

**NOTE**

Consider using the autopilot to reduce workload. Using GPSS mode can assist in maintaining a flight-planned route.

- ALTR .....OFF
- ALTR FIELD circuit breaker .....Check and reset as required
- ALTR .....ON

**If primary alternator power not restored:**

- ALTR .....OFF

If primary alternator output cannot be restored, maintain an electrical load of less than 20 amps with which the STBY ALTR ON annunciator no longer flashes and *land as soon as practical.*

**SECTION 3 - EMERGENCY PROCEDURES (continued)**

**ALTERNATOR FAILURE (continued)**

**Failure of Standby Alternator**

If STBY ALTR ON is not illuminated:

- Day/Night Switch.....VERIFY correct position
- STBY ALTR .....OFF
- STBY ALTR FIELD circuit breaker .....Check and reset as required
- STBY ALTR SENSE circuit breaker .....Check and reset as required
- STBY ALTR .....ON

**If standby alternator power not restored:**

STBY ALTR .....OFF

If the standby alternator has failed or cannot provide adequate power, then electrical power is dependent on available battery storage. Duration of battery power available will be dependent on electrical load and battery condition prior to failure. Execute **Complete Electrical Failure** checklist when battery is depleted.

*Land as soon as possible.*

**WARNING**

Compass error may exceed 10 degrees with alternator inoperative.

**CAUTION**

Any power interruption will result in loss of attitude information from the PFD until the unit can be reinstated on the ground.

**NOTE**

LO BUS VOLTAGE annunciator will be illuminated. Anticipate complete electrical failure. Duration of battery power available will be dependent on electrical load and battery condition prior to failure.

**NOTE**

If the battery is depleted, the landing gear must be lowered using the emergency extension procedure. The gear position lights will be inoperative.



**SECTION 3 - EMERGENCY PROCEDURES (continued)**  
**ALTERNATOR FAILURE (continued)**

Reduce electrical loads by switching OFF or pulling circuit breakers for all non-essential equipment to include the following:

- Reduce PFD and MFD brightness as part of overall electrical system management
- Pitot heat (unless required)
- Airconditioner and ventilation fan (if installed)
- Landing light (use sparingly)
- Strobe lights
- Nav lights
- Recognition lights (if equipped)
- Cabin/flood lights
- No. 2 nav/com/GPS
- Autopilot (if equipped)
- Electric trim (if equipped)
- DME (unless required for published approach) (if equipped)
- Stormscope (if equipped)
- Skywatch (if equipped)

*Land as soon as possible.*

**SECTION 3 - EMERGENCY PROCEDURES (continued)**

**Electrical Overload (Alternator over 20 amps above known electrical load)**

ALTR.....ON  
BATT MASTR .....OFF



**If alternator loads are reduced:**

Electrical load .....Reduce to minimum

**NOTE**

Due to increased system voltage and radio frequency noise, operation with ALTR switch ON and BATT MASTR switch OFF should be made only when required by an electrical system failure.

**If alternator loads are not reduced:**

BATT.....ON  
ALT .....OFF  
STBY ALTR .....Select ON/check ammeter indication  
Engine RPM.....Increase to a minimum of 2500  
Electrical Load .....Reduce until total load is below 20 amps

**NOTE**

If the STBY ALTR ON annunciator is flashing then reduce electrical loads until the annunciator no longer flashes.



If the standby alternator has failed or cannot provide adequate power, then electrical power is dependent on available battery storage. Duration of battery power available will be dependent on electrical load and battery condition prior to failure. Execute **Complete Electrical Failure** checklist when battery is depleted.

**WARNING**

Compass error may exceed 10 degrees with alternator inoperative.

**CAUTION**

A power interruption greater than 20 seconds will result in loss of attitude information from the PFD until the unit can be reinstated on the ground.

**NOTE**

If the battery is depleted, the landing gear must be lowered using the emergency extension procedure. The gear position lights will be inoperative.



**SECTION 3 - EMERGENCY PROCEDURES (continued)****Electrical Overload (Alternator over 20 amps above known electrical load)  
(continued)**

Reduce electrical loads by switching OFF or pulling circuit breakers for all non-essential equipment to include the following:

- Reduce PFD and MFD brightness as part of overall electrical system management
- Pitot heat (unless required)
- Airconditioner and ventilation fan (if installed)
- Landing light (use sparingly)
- Strobe lights
- Nav lights
- Recognition lights (if equipped)
- Cabin/flood lights
- No. 2 nav/com/GPS
- Autopilot (if equipped)
- Electric trim (if equipped)
- DME (unless required for published approach) (if equipped)
- Stormscope (if equipped)
- Skywatch (if equipped)

*Land as soon as practical.*

**SECTION 3 - EMERGENCY PROCEDURES (continued)**

**Complete Electrical Failure**

Standby Attitude Gyro .....SELECT Standby (STBY) power button

**CAUTION**

The STBY PWR annunciator will rapidly flash for approximately one minute when aircraft power is lost. STBY PWR must be selected, otherwise the gyro will auto shutdown after approximately one minute.

Standby Attitude Gyro .....VERIFY ON and  
flag is pulled on gyro

Maintain aircraft control with reference to the standby airspeed, altimeter, and attitude gyro indicators.

Battery Switch .....OFF

**Prior to descent:**

Mixture .....FULL RICH

*Land as soon as possible.*

**WARNING**

Compass error may exceed 10 degrees with alternator inoperative.

**NOTE**

If the battery is depleted, the landing gear must be lowered using the emergency extension procedure. The gear position lights will be inoperative.

**SECTION 3 - EMERGENCY PROCEDURES (continued)**

**Fire in Flight**

*Electrical Fire*

- Fire.....Extinguish
- Battery Master Switch.....OFF
- ALTR Switch.....OFF
- STBY ALTR Switch.....OFF
- Standby Attitude Gyro.....SELECT Standby (STBY) power button

**CAUTION**

The STBY PWR annunciator will rapidly flash for approximately one minute when aircraft power is lost. STBY PWR must be selected, otherwise the gyro will auto shutdown after approximately one minute.

- Standby Attitude Gyro .....VERIFY ON and  
flag is pulled on gyro

Maintain aircraft control with reference to the standby airspeed, altimeter, and attitude gyro indicators.

- Vents .....OPEN
- Cabin Heat.....OFF

**Prior to descent:**

- Mixture.....FULL RICH

*Land as soon as practical.*

**WARNING**

Compass error may exceed 10 degrees with alternator inoperative.

**NOTE**

If the battery is depleted, the landing gear must be lowered using the emergency extension procedure. The gear position lights will be inoperative.

**SECTION 3 - EMERGENCY PROCEDURES (continued)**

**Aircraft Engine Power Loss**

During an engine failure the pilot may elect to attempt an engine restart. During this time large voltage drops may cause the PFD to lose power and reinitialize. During this initialization process the PFD may not be able to complete a fast alignment during flight and therefore the pilot may have to obtain aircraft attitude and aircraft control using the standby instruments.

- Refer to the Emergency Section of the Pilot's Operating Handbook.
  - If the PFD is able to perform fast alignment, when prompted by the PFD:
    - Maintain straight and level flight
- OR**
- If engine does not restart, maintain wings level and appropriate aircraft speed.
  - Press the fast erect button.
  - If the PFD was not able to perform fast alignment, maintain aircraft control with reference to the standby instruments for aircraft attitude information.

**CAUTION**

In case of engine failure, minimize the use of the starter and turn off all non-essential electrical equipment to preserve battery capacity.

**NOTE**

If standby alternator is installed, select it to OFF when primary alternator is OFF.

**Loss of Fuel Flow**

Electric Fuel Pump .....ON  
 Fuel Selector .....Check on tank containing usable fuel

**Engine Driven Fuel Pump Failure**

Throttle .....RETARD  
 Electric Fuel Pump .....ON  
 Throttle.....RESET as required

**CAUTION**

If normal engine operation and fuel flow is not immediately re-established, the electric fuel pump should be turned OFF. The lack of fuel flow indication while the electric pump is on could indicate a leak in the fuel system or fuel exhaustion. If fuel system leak is verified, switch fuel selector to OFF.

**SECTION 3 - EMERGENCY PROCEDURES (continued)****Loss of Heading Accuracy**

Indication:

- Difficulty maintaining course while using VOR or GPS.
- Excessive difference between heading and track required maintaining a VOR or GPS course.
- ATC indicates the aircraft is on a wrong heading.
- Excessive deviation between PFD heading and magnetic compass.  
( $>10^\circ$  after compass deviation applied.)

If heading systems differ by more than  $10^\circ$  (after compass deviation applied):

- Use magnetic compass for primary heading reference.

**CAUTION**

High current loads in the vicinity of the magnetic compass can influence its accuracy. Depending on the flight conditions, the pilot must reduce these loads as much as possible to insure accuracy. Tests have shown that air conditioner and pitot heat contribute to significant heading errors of the magnetic compass. These items should be turned OFF prior to comparing the magnetic compass to the PFD heading.

SECTION 4 - NORMAL PROCEDURES

Engine Start - General

**CAUTION**

Do not attempt flight if there is no indication of primary alternator output.

**CAUTION**

If a positive oil pressure is not indicated within 30 seconds following an engine start, stop the engine and determine the trouble. In cold weather it will take a few seconds longer to get a positive oil pressure indication.

**NOTE**

Starter manufacturer recommends starter cranking periods be limited to 10 seconds with a 20 second rest period between cranking attempts. Maximum of 6 start periods allowed. If start is not achieved on sixth attempt allow starter to cool for 30 minutes before attempting additional starts.

**Before Starting Engine**

Passengers .....BOARD  
Door .....CLOSE and LATCH  
Seats .....ADJUSTED and LOCKED in position  
Seat Belts and Harnesses .....FASTEN/ADJUST  
Brakes .....SET  
Gear Selector .....GEAR DOWN  
Circuit Breakers.....Check IN  
Alternate Air .....OFF  
Propeller .....Full INCREASE rpm  
Avionics .....OFF  
Fuel Selector.....Desired tank



**SECTION 4 - NORMAL PROCEDURES (continued)**

**Normal Start - Cold Engine**

- Throttle ..... 1/2 inch open
- Battery Master Switch..... ON
- Primary Flight Display (PFD) ..... Verify correct aircraft  
model software
- Alternator Switch ..... ON
- Standby Alternator Switch..... OFF
- Electric Fuel Pump ..... ON
- Mixture ..... RICH - then IDLE CUT-OFF
- Propeller..... CLEAR
- Starter ..... ENGAGE
- Mixture..... ADVANCE
- Throttle..... ADJUST
- Oil Pressure ..... CHECK

**Normal Start - Hot Engine**

- Throttle ..... 1/2 inch open
- Battery Master Switch..... ON
- Primary Flight Display (PFD) ..... Verify correct aircraft  
model software
- Alternator Switch ..... ON
- Standby Alternator Switch..... OFF
- Electric Fuel Pump ..... ON
- Mixture ..... IDLE CUT-OFF
- Propeller..... CLEAR
- Starter ..... ENGAGE
- Mixture..... ADVANCE
- Throttle..... ADJUST
- Oil Pressure ..... CHECK

**SECTION 4 - NORMAL PROCEDURES (continued)**

**Engine Start When Flooded**

Throttle .....Open full  
Battery Master Switch.....ON  
Primary Flight Display (PFD) .....Verify correct aircraft  
model software  
Alternator Switch .....ON  
Standby Alternator Switch.....OFF  
Electric Fuel Pump .....OFF  
Mixture .....IDLE CUT-OFF  
Propeller.....CLEAR  
Starter .....ENGAGE  
Mixture .....Full rich  
Throttle .....RETARD  
Oil Pressure .....CHECK



**SECTION 4 - NORMAL PROCEDURES (continued)**

**Starting With External Power Source**

**CAUTION**

It is possible to use the ship's battery in parallel by turning only the battery master switch ON. This will give longer cranking capabilities, but will not increase the amperage. Care should be exercised because if the ship's battery has been depleted, the external power supply can be reduced to the level of the ship's battery. This can be tested by turning on the battery master switch momentarily while the starter is engaged. If cranking speed increases, the ship's battery is at a higher level than the external power supply.

**NOTE**

For all normal operations using external power, the battery master and alternator switches should be OFF.

- Battery Master Switch .....OFF
- Alternator Switch.....OFF
- Standby Alternator Switch.....OFF
- All Electrical Equipment .....OFF
- External Power Plug .....Insert in fuselage
- Proceed with normal start checklist
- Throttle .....Lowest possible RPM
- External Power Plug .....Disconnect from fuselage
- Battery Master Switch.....ON
- Alternator Switch .....ON - check ammeter
- Oil Pressure .....CHECK

**SECTION 4 - NORMAL PROCEDURES (continued)**

**Ground Check**

- Throttle .....2300 RPM
- ALTR switch .....OFF
- STBY ALTR switch .....ON
- STBY ALTR ON annunciator .....verify ON
- Increase electrical load to over 20 amps.
- STBY ALTR ON annunciator .....verify flashing
- Decrease electrical load to less than 20 amps.
- STBY ALTR ON annunciator .....verify ON (steady)
- Throttle .....retard
- ALTR switch .....ON
- STBY ALTR switch .....OFF
- Verify normal amperage indication.
- STBY ALTR ON annunciator .....verify extinguished



**Taxiing**

**NOTE**

During operations with low engine RPM, electrical system voltage may decrease below 12.5 volts, causing the LO BUS VOLTAGE annunciator to be illuminated.



**Before Takeoff**

- STBY ALTR switch .....verify OFF

**Stopping Engine**

- STBY ALTR switch .....OFF

**SECTION 5 - PERFORMANCE**

No change from basic Handbook.

**SECTION 6 - WEIGHT AND BALANCE**

No change from basic Handbook.



**SECTION 7 - DESCRIPTION AND OPERATION****A. PFD Systems Description****NOTE**

This supplement provides a general description of the Avidyne FlightMax Entegra Series 700-00006-0XX-( ) PFD, its operation, and aircraft systems interfaces. For a detailed description of PFD operation, refer to the Avidyne FlightMax Entegra Series Primary Flight Display Pilot's Guide, p/n 600-00104-000 revision 00 or appropriate later revision, or 600-00143-000 revision 01 (EXP 5000 R6) or appropriate later revision.

The Entegra PFD start-up is automatic once power is applied. The display presents the Initialization Display immediately after power is applied. Power-on default is 75% brightness. Typical alignment times are 3 minutes once power is applied.

**Attitude Direction Indicator (ADI)**Air Data

The airspeed tape to the left of the main ADI begins indicating at 20 Knots Indicated Airspeed (IAS) and is color coded in accordance with the model POH airspeeds for  $V_{SO}$ ,  $V_{FE}$ ,  $V_s$ ,  $V_{NO}$ , and  $V_{NE}$ . An altitude tape is provided to the right of the main ADI and also displays a symbol for the Altitude Preselect (Altitude Bug). The Vertical Speed Indicator (VSI) is displayed to the right of the altitude tape. For vertical speed rates greater than the PFD displayed VSI scale, the indicator needle will peg just outside the scale and a digital readout of actual VSI up to 4000 FPM is then displayed. An additional data block is provided for display of Outside Air Temperature (OAT), True Airspeed (TAS), and Ground Speed (GS). Controls for selecting bug and barometric correction values are along the right side of the PFD. A wind indicator is also provided beneath the altitude tape.

Attitude Data

Attitude is depicted on the main ADI using a combination of an aircraft reference symbol ("flying-delta") against a background of labeled pitch ladders for pitch and a bank angle pointer in the form of an arced scale along the top of the main ADI for bank. A skid/slip indicator is attached to the bottom edge of the bank angle pointer.

**SECTION 7 - DESCRIPTION AND OPERATION (continued)**

**A. PFD Systems Description (continued)**

**Horizontal Situation Indicator (HSI)**

Heading Data

Magnetic heading is represented in a boxed digital form at the top of the compass rose. Heading rate (Rate of Turn Indicator) takes the form of a blue arcing arrow that begins behind the magnetic heading indicator and moves left or right accordingly. Graduations are provided on the rate of turn indicator scale to indicate ½ and full standard rate turns. A heading bug is also provided on the compass rose.

Navigation Data

Navigation data on the PFD takes several forms. A Course Deviation Indicator (CDI) is always provided on the HSI and a bearing pointer can be optionally selected for display on the HSI by the pilot. Controls for selecting the source of navigation data, selecting the display format of the navigation data, and for selecting the type of compass rose and moving map to be displayed are along the left side of the PFD. The active flight plan contained in the GPS Nav/Comm unit selected as the primary navigation source (Nav) can be optionally selected for display on the HSI as well as the desired range of the optionally selectable moving map display. If a localizer or ILS frequency is tuned and captured in the GPS Nav/Comm selected as the Nav source, a Vertical Deviation Indicator (VDI) and Horizontal Deviation Indicator (HDI) are automatically displayed on the ADI.

While executing an ILS or localizer only approach, the course deviation indicator (CDI) and glideslope needles on the PFD, as appropriate, may exhibit a slight oscillatory motion. The oscillatory motion increases from zero amplitude at approximately 2500 rpm to approximately ½ dot total amplitude at 2700 rpm. The GI-106 mechanical VOR Indicator needles exhibit this same behavior, only to a lesser degree. The pilot should fly the “average” localizer/glideslope needle position or decrease engine rpm to reduce needle oscillation.

**NOTE**

In the event glide slope or localizer signals are lost, the HDI and/or VDI will be displayed as red X's to indicate loss of signal. The red X'd indicator will only be removed if the signal is regained. In this case, the PFD Nav source will set to GPS, or if the GPS Nav/Comm is retuned, to another frequency. Appropriate action must be taken by the pilot if on an approach.

**SECTION 7 - DESCRIPTION AND OPERATION (continued)****A. PFD Systems Description (continued)****Autopilot Integration**

The Entegra PFD is fully integrated with the S-TEC System 55X Autopilot. Reference bugs for Heading, Altitude, and Vertical Speed are provided on the PFD to control the autopilot and aid pilot situational awareness. These bugs are displayed with solid or hollow symbology depending on the autopilot status. If the autopilot is engaged in that mode, the bug is solid to indicate the autopilot is coupled to that bug. A hollow bug indicates the autopilot is not engaged in that mode.

Autopilot mode annunciations are shown on the S-TEC System 55X computer. When included as part of the installation, autopilot mode annunciations including autopilot ready and fail indications are provided at the top of the PFD screen.

When included as part of the installation, flight director command bars on the PFD attitude indicator can be enabled by the pilot. When the flight director is enabled and the autopilot is engaged in both lateral and vertical modes, the flight director displays the goals of the autopilot.

A lateral autopilot mode must be engaged on the S-TEC System 55X before a vertical mode can be engaged.

The flight director command bars will only be displayed on the PFD when enabled by the pilot and when both lateral and vertical autopilot modes are engaged.

**SECTION 7 - DESCRIPTION AND OPERATION (continued)**

**A. PFD Systems Description (continued)**

**Autopilot Integration (continued)**

The following autopilot modes are supported by the PFD:

1. HDG (Heading, using the heading bug)
2. NAV (Nav, using the course pointer and course deviation indicator)
3. GPSS (GPS Steering, using GPS course guidance)
4. APR (Approach, using the HDI and VDI, including automatic glide slope capture)
5. REV (Reverse sensing HDI approach)
6. ALT (Altitude Hold and Preselect, using the altitude bug)
7. VS (Vertical Speed, using the vertical speed bug)

**NOTE**

When HDG mode is engaged, rotation of the heading bug greater than 180° will result in a reversal of turn direction.

**CAUTION**

If a VLOC is selected in NAV on the PFD and GPSS mode is engaged on the autopilot, the autopilot will track the active flight plan in GPS1 if VLOC1 is selected or GPS2 if VLOC2 is selected and not track VLOC1 or VLOC2 as the selected source in NAV on the PFD. Therefore, the course deviation on the PFD CDI and the course deviation flown by the autopilot can be different. This situation may be confusing and should be avoided.



**SECTION 7 - DESCRIPTION AND OPERATION (continued)****A. PFD Systems Description (continued)****Engine Instruments**

The Entegra PFD provides a display of Engine Manifold Pressure, Tachometer (RPM), Oil Pressure (OP), and Fuel Flow (FF) in the upper left hand corner of the display.

**Manifold Pressure -**

Continuously displays engine manifold pressure in inches of mercury (In.-Hg.). A numeric display below the manifold pressure analog indicator displays the manifold pressure to the nearest 0.1 In.-Hg. If the manifold pressure enters the warning (red) area, the analog indicator and the numeric readout will be displayed in the corresponding color.

**Tachometer -**

Continuously displays the current propeller RPM. A numeric display below the RPM analog indicator displays the RPM to the nearest 10 RPM. If the propeller RPM enters the warning (red) area, the analog indicator and the numeric readout will be displayed in the corresponding color.

**Oil Pressure -**

Numerically displays oil pressure during engine start in pounds per square inch (PSI) to the nearest 1 PSI. The oil pressure indication is removed 3 minutes after the engine oil pressure is outside the warning (red) range.

**Fuel Flow -**

Continuously displays numeric fuel flow in gallons per hour (GPH) to the nearest 0.1 GPH.

**Back-up Instruments**

The Entegra PFD system installation includes redundant means of display of certain aircraft flight and systems parameters. Back-up Altimeter, Airspeed and Attitude instruments are provided to facilitate pilot cross-checking of PFD display flight parameters. The aircraft wet compass serves as a back-up heading source.

**SECTION 7 - DESCRIPTION AND OPERATION (continued)**

**B. MFD Systems Description**

**NOTE**

This supplement provides a general description of the Avidyne EX5000 Series 700-00004-0XX-( ) MFD, its operation and aircraft interface. For a detailed description of the MFD, refer to the Avidyne FlightMax EX5000 Series Pilot's Guide and Reference, p/n 600-00105-000 revision 00 or appropriate later revision.

**Navigation**

Data associated with the moving map is found on four pages: Map, Nearest, Trip, and Info pages. The MFD contains a Jeppesen NavData database that is available for display on the Map page. In conjunction with GPS-supplied position information, an own-ship symbol is superimposed on the moving map and positioned relative to the NavData information. GPS can also supply the active flight plan for display on the moving map. Terrain data is provided by a USGS terrain database stored within the MFD and updated only on an as needed basis.

The Jeppesen Navigation Database provides data on airports, approaches, VOR's, NDB's, intersections, airspace definitions, and frequencies. North American and international databases are available. Database information can be updated via the USB port on the front face of the bezel.

The navigation data on the moving map display are based on databases that are updated periodically. Database updates are available on 28-day cycle subscriptions. Expired databases are clearly stated to the pilot via messages during system startup and on the System Setup page. The warning can only be removed by updating the data.

NOAA man-made obstruction database information provides data on man-made obstacles over 200 feet AGL. This data is only available for North America and can be updated via the USB port on the front face of the bezel.

The obstacle data on the moving map display are based on databases that are updated periodically. Database updates are available from Avidyne on 56-day cycle subscriptions. Expired databases are clearly stated to the pilot via messages during system startup and on the System Setup page. The warning can only be removed by updating the data.

**SECTION 7 - DESCRIPTION AND OPERATION (continued)****B. MFD Systems Description (continued)****Navigation (continued)**

Using the Jeppesen NavData data and the GPS-supplied present position, the MFD can provide the pilot with the nearest 25 airports or navaids, depending on pilot selection, within 100 nm. This information is presented on the Nearest page.

More detailed information on a particular airport is also generated from the Jeppesen NavData data and is available for pilot viewing on the Info page.

Flight plan data supplied by the GPS system provide the pilot with a tabular form of the remaining legs in the active GPS flight plan. This information is viewed on the Trip page and includes a CDI for added enroute navigation aiding.

Flight plan data is transmitted to the MFD from an external GPS navigator. Some installations do not support depictions of curved flight paths. In these cases, curved flight path segments will be depicted as straight lines. The GPS navigator and HSI are to be used during approach procedures. Reference the Avidyne FlightMax EX5000 Series Pilot's Guide, p/n 600-00105-000, for more information.

**Datalink**

Datalink information is received by the MFD based upon installation provisions and a subscription service available through Avidyne ([www.myavidyne.com](http://www.myavidyne.com)). Data is presented on the Map, Trip, and Nearest pages. Datalink information is provided for strategic planning purposes only. Data aging and transport considerations make it unsuitable for tactical use. Reference the Avidyne FlightMax EX5000 Series Pilot's Guide, p/n 600-00105-000, for more information.

**Setup**

The various System Setup pages allow the pilot to set user preferences for system operation. In addition to listing the software version identification information and database validity dates, the System Setup page allows access to several pages for preference selection and provides a means to initiate self-tests of the traffic and lightning sensors.

---

**SECTION 7 - DESCRIPTION AND OPERATION (continued)**

**B. MFD Systems Description (continued)**

**Setup (continued)**

**Airport Settings** page provides selections for displaying airport type, runway surface type and minimum runway lengths on the moving map. **Declutter Settings** page allows the pilot to select settings for defining the base map detail when changing display range. **System Time** page provides an opportunity to select system time zone and Map page menu timeout options. **DataBlock Edit** page allows the pilot to select the data to be displayed in the datablock windows on the Map page. **Datalink Setup** page allows the pilot to select parameters for the datalink system, including update rate and range of weather data request.

**Engine Instruments**

The Engine page provides the pilot with engine parameters depicted on simulated gauges and electrical system parameters located in dedicated regions within the MFD display. An Engine Sensor Unit interfaces with engine-mounted sensors and provides data to the MFD for display.

A leaning function assists the pilot in leaning the engine for best power or best fuel economy. To initiate the leaning function, press the Lean Assist bezel key and proceed to lean the engine fuel mixture. Best economy is achieved when the engine is operating at peak EGT of the leanest cylinder (first cylinder to peak), as recommended by the engine manufacturer. Best power is achieved when the engine is leaned 100°F rich of the first cylinder to reach peak EGT. When leaning is complete, select Absolute or Normalize to complete the leaning process. A digital readout of EGT change from the peak value is provided for reference. Reference the Avidyne FlightMax EX5000 series Pilot's Guide, p/n 600-00105-000, for more information.

**SECTION 7 - DESCRIPTION AND OPERATION (continued)****C. STANDBY ALTERNATOR System Description**

The B&C Specialty Products Standby Alternator system delivers electrical power to the aircraft electrical power bus in the event of failure of the primary alternator. Powering the bus allows the pilot flexibility to choose equipment suitable to the current flight conditions. Equipment that would otherwise deplete the battery reserve may be used within the standby alternator's current limit.

As long as the electrical load is maintained below standby alternator capacity, the bus voltage will not fall below 13.0 volts and the battery will remain charged. As long as a minimum bus voltage of 13 volts is maintained, battery energy will be available for landing lights and other approach loads.

The standard aircraft amperage indication represents the standby alternator output when the STBY ALTR ON annunciator is lit.

The standby alternator is capable of outputs greater than maximum continuous load for less than 5 minutes without damage. Extended operation over rated load may cause immediate or premature alternator failure and battery depletion.

**ISSUED: JULY 12, 1995**  
**REVISED: MAY 22, 2006**

**REPORT: VB-1612**  
**35 of 36, 9-157**

**THIS PAGE INTENTIONALLY LEFT BLANK**

**PILOT'S OPERATING HANDBOOK  
AND  
FAA APPROVED AIRPLANE FLIGHT MANUAL**

**SUPPLEMENT NO. 19  
FOR  
BENDIX/KING KR-87 DIGITAL ADF  
WITH KI-227 INDICATOR**

This supplement must be attached to the Pilot's Operating Handbook and FAA Approved Airplane Flight Manual when the Bendix/King KR-87 Digital ADF with the KI-227 Indicator is installed per the Equipment List. The information contained herein supplements or supersedes the Pilot's Operating Handbook and FAA Approved Airplane Flight Manual only in those areas listed herein. For limitations, procedures and performance information not contained in this supplement, consult the Pilot's Operating Handbook and FAA Approved Airplane Flight Manual.

FAA APPROVED:

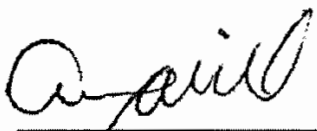

Albert J. Mill  
DOA-510620-CE  
Piper Aircraft, Inc.  
Vero Beach, Florida

DATE OF APPROVAL: January 21, 2009

**SECTION 1 - GENERAL**

The Bendix/King Digital ADF is a panel mounted, digitally tuned, automatic direction finder. It is designed to provide continuous 1 kHz digital tuning in the frequency range of 200 kHz to 1799 kHz and eliminates the need for mechanical band switching. The system is comprised of a receiver, a built-in electronic timer, a bearing indicator and a KA-44B combined loop and sense antenna.

The Bendix/King Digital ADF can be used for position plotting and homing procedures, and for aural reception of amplitude modulated (AM) signals.

The "flip-flop" frequency display allows switching between pre-selected "STANDBY" and "ACTIVE" frequencies by pressing the frequency transfer button. Both preselected frequencies are stored in a non-volatile memory circuit (no battery power required) and displayed in self-dimming gas discharge numerics. The active frequency is continuously displayed in the left window, while the right window will display either the standby frequency or the selected readout from the built-in timer.

The built-in electronic timer has two separate and independent timing functions: (1) An automatic flight timer that starts whenever the unit is turned on. This timer functions up to 59 hours and 59 minutes. (2) An elapsed timer which will count up or down for up to 59 minutes and 59 seconds. When a preset time interval has been programmed and the countdown reaches :00, the display will flash for 15 seconds. Since both the flight timer and elapsed timer operate independently, it is possible to monitor either one without disrupting the other. The pushbutton controls and the bearing indicator are internally lighted.

**SECTION 2 - LIMITATIONS**

No change.

**SECTION 3 - EMERGENCY PROCEDURES**

No change.



**SECTION 4 - NORMAL PROCEDURES**

**To Operate as an Automatic Direction Finder:**

1. OFF/VOL Control - ON.
2. Frequency Selector Knobs - SELECT desired frequency in the standby frequency display.
3. FRQ Button - PRESS to move the desired frequency from the standby to the active position.
4. ADF SPEAKER/PHONE - Selector Switch (on audio control panel) - SELECT as desired.
5. OFF/VOL Control - SET to desired volume level.
6. ADF Button - SELECT ADF mode and note relative bearing on indicator.

**ADF Test (Pre-flight or In-flight):**

1. ADF Button - SELECT ANT mode and note pointer moves to 90° position.
2. ADF Button - SELECT ADF mode and note the pointer moves without hesitation to the station bearing. Excessive pointer sluggishness, wavering or reversals indicate a signal that is too weak or a system malfunction.

**SECTION 4 - NORMAL PROCEDURES (continued)**

**NOTE**

The Standby Frequency which is in memory while Flight Time or Elapsed Time modes are being displayed may be called back by pressing the FRQ button, then transferred to active use by pressing the FRQ button again.

**To Operate Elapsed Time Timer-Count Down Mode:**

1. OFF/VOL Control - ON.
2. FLT/ELT Mode Button - PRESS (once or twice) until ET is annunciated.
3. SET/RST Button - PRESS until the ET annunciation begins to flash.
4. FREQUENCY SELECTOR KNOBS - SET desired time in the elapsed time display. The small knob is pulled out to tune the 1's. The small knob is pushed in to tune the 10's. The outer knob tunes minutes up to 59 minutes.

**NOTE**

Selector knobs remain in the time set mode for 15 seconds after the last entry or until the SET/RST, FLT/ET, or FRQ button is pressed.

5. SET/RST Button - PRESS to start countdown. When the timer reaches 0, it will start to count up as display flashes for 15 seconds.

**NOTE**

While FLT or ET are displayed, the active frequency on the left side of the window may be changed, by using the frequency selector knobs, without any effect on the stored standby frequency or the other modes.

**SECTION 4 - NORMAL PROCEDURES (continued)****ADF Operation NOTES:***Erroneous ADF Bearing Due to Radio Frequency Phenomena:*

In the U.S., the FCC, which assigns AM radio frequencies, occasionally will assign the same frequency to more than one station in an area. Certain conditions, such as Night Effect, may cause signals from such stations to overlap. This should be taken into consideration when using AM broadcast station for navigation.

Sunspots and atmospheric phenomena may occasionally distort reception so that signals from two stations on the same frequency will overlap. For this reason, it is always wise to make positive identification of the station being tuned, by switching the function selector to ANT and listening for station call letters.

*Electrical Storms:*

In the vicinity of electrical storms, an ADF indicator pointer tends to swing from the station tuned toward the center of the storm.

*Night Effect:*

This is a disturbance particularly strong just after sunset and just after dawn. An ADF indicator pointer may swing erratically at these times. If possible, tune to the most powerful station at the lowest frequency. If this is not possible, take the average of pointer oscillations to determine relative station bearing.

*Mountain Effect:*

Radio waves reflecting from the surface of mountains may cause the pointer to fluctuate or show an erroneous bearing. This should be taken into account when taking bearings over mountainous terrain.

*Coastal Refraction:*

Radio waves may be refracted when passing from land to sea or when moving parallel to the coastline. This also should be taken into account.

**SECTION 5 - PERFORMANCE**

No change.

**SECTION 6 - WEIGHT AND BALANCE**

Factory installed optional equipment is included in the licensed weight and balance data in Section 6 of the Pilot's Operating Handbook and Airplane Flight Manual.

SECTION 7 - DESCRIPTION AND OPERATION

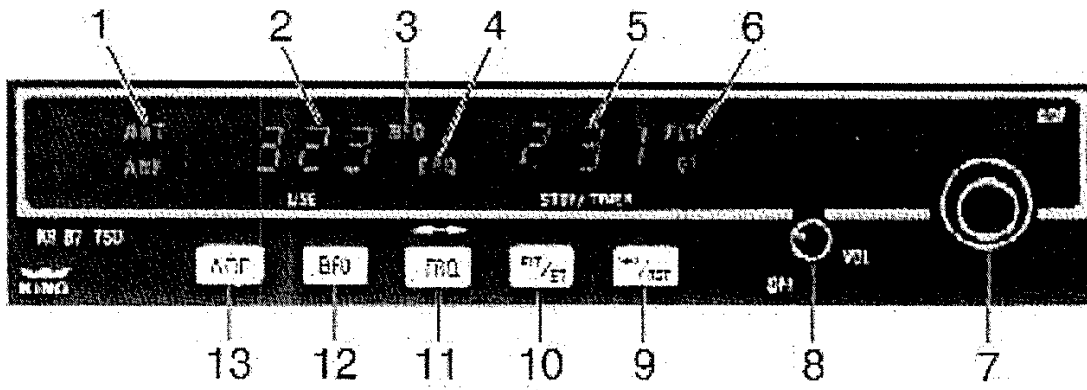

KR-87 Digital ADF

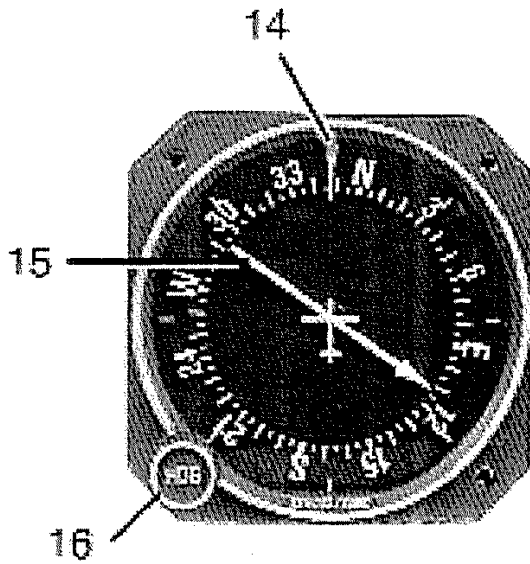

KI-227 Indicator

King Digital ADF Operating Controls and Indicators

Figure 1

**SECTION 7 - DESCRIPTION AND OPERATION (continued)**

**Legend - Figure 1**

1. Mode Annunciation - Antenna (ANT) is selected by the "out" position of the ADF button. This mode improves the aural reception and is usually used for station identification. The bearing pointer is deactivated and will park in the 90° relative position. Automatic Direction Finder (ADF) mode is selected by the depressed position of the ADF button. This mode activates the bearing pointer. The bearing pointer will point in the direction of the station relative to the aircraft heading.
2. Active Frequency Display - The frequency to which the ADF is tuned is displayed here. The active ADF frequency can be changed directly when either of the timer functions are selected.
3. Beat Frequency Oscillator (BFO) - The BFO mode, activated and annunciated when the "BFO" button is depressed, permits the carrier wave and associated morse code identifier broadcast on the carrier wave to be heard.

**NOTE**

CW signals (Morse Code) are unmodulated and no audio will be heard without use of BFO. This type of signal is not used in the United States air navigation. It is used in some foreign countries and marine beacons.

4. Standby Frequency Annunciation (FRQ) - When FRQ is displayed, the STANDBY frequency is displayed in the right hand display. The STANDBY frequency is selected using the frequency select knobs. The selected STANDBY frequency is put into the ACTIVE frequency window by pressing the frequency transfer button.
5. Standby Frequency Display - Either the standby frequency, the flight timer, or the elapsed time is displayed in this position. The flight timer and elapsed timer are displayed replacing the standby frequency which goes into "blind" memory to be called back at any time by depressing the FRQ button. Flight time or elapsed time are displayed and annunciated alternatively by depressing the FLT/ET button.

**SECTION 7 - DESCRIPTION AND OPERATION (continued)****Legend - Figure 1 (continued)**

6. Timer Mode Annunciation - Either the elapsed time (ET) or flight time (FLT) mode is annunciated here.
7. Frequency Selector Knobs - Selects the standby frequency when FRO is displayed and directly selects the active frequency whenever either of the timer functions is selected. The frequency selector knobs may be rotated either clockwise or counterclockwise. The small knob is pulled out to tune the 1's. The small knob is pushed in to tune the 10's. The outer knob tunes the 100's with rollover into the 1000's. These knobs are also used to set the desired time when the elapsed timer is used in the countdown mode.
8. Off/Volume Control (OFF/VOL) - Controls primary power and audio output level. Clockwise rotation from OFF position applies primary power to receiver; further clockwise rotation increases audio level. Audio muting causes the audio output to be muted unless the receiver is locked on a valid station.
9. Set/Reset Button (SET/RST) - The set/reset button, when pressed, resets the elapsed timer whether it is being displayed or not.
10. Flight Time/Elapsed Time Mode Selector Button (FLT/ET) - The Flight Timer/Elapsed Time mode selector button, when pressed, alternatively selects either Flight Timer mode or Elapsed Timer mode.
11. Frequency Transfer Button (FRQ) - The FRQ transfer button, when pressed, exchanges the active and standby frequencies. The new frequency becomes active and the former active frequency goes into standby.
12. BFO Button - The BFO button selects the BFO mode when in the depressed position (see Note under item 3).
13. ADF Button - The ADF button selects either the ANT mode or the ADF mode. The ANT mode is selected with the ADF button in the out position. The ADF mode is selected with the ADF button in the depressed position.
14. Index (Rotatable Card) - Indicates relative, magnetic, or true heading of aircraft, as selected by the HDG control.

**SECTION 7 - DESCRIPTION AND OPERATION (continued)**

**Legend - Figure 1 (continued)**

15. Pointer - Indicates station bearing in degrees of azimuth, relative to the nose of the aircraft. When heading control is adjusted, indicates relative, magnetic, or true bearing of radio signal.
16. Heading Card Control (HDG) - Rotates card to set in relative, magnetic, or true bearing information.



**PILOT'S OPERATING HANDBOOK  
AND  
FAA APPROVED AIRPLANE FLIGHT MANUAL**

**SUPPLEMENT NO. 20  
FOR  
BENDIX/KING KN-63 DME**

This supplement must be attached to the Pilot's Operating Handbook and FAA Approved Airplane Flight Manual when the Bendix/King KN-63 DME is installed per the Equipment List. The information contained herein supplements or supersedes the Pilot's Operating Handbook and FAA Approved Airplane Flight Manual only in those areas listed herein. For limitations, procedures and performance information not contained in this supplement, consult the Pilot's Operating Handbook and FAA Approved Airplane Flight Manual.

FAA APPROVED:



Albert J. Mill  
DOA-510620-CE  
Piper Aircraft, Inc.  
Vero Beach, Florida

DATE OF APPROVAL: January 21, 2009

**SECTION 1 - GENERAL**

The Bendix/King KN-63 DME supplies continuous slant range distance information from a fixed ground station to an aircraft in flight.

The equipment consists of a KDI-572 Panel Display which contains all the operating controls and displays, and a remotely mounted KN-63 Receiver-Transmitter. The KDI-572 Panel Display digitally displays distances in nautical miles, ground speed in knots, and time to station in minutes. All displays are in self-dimming gas discharge numerics.

**SECTION 2 - LIMITATIONS**

No change.

**SECTION 3 - EMERGENCY PROCEDURES**

No change.

**SECTION 4 - NORMAL PROCEDURES**

**DME Operation**

1. DME Mode Selector Switch - SET to N1 or N2.
2. NAV 1 and NAV 2 VHF Navigation Receivers - ON; SET FREQUENCY selector switches to VOR/DME station frequencies, as required.

**NOTE**

When the VOR frequency is selected, the appropriate DME frequency is automatically channeled.

3. DME SPEAKER/PHONE selector buttons (on audio control panel) - SET to desired mode.

**SECTION 5 - PERFORMANCE**

No change.

**SECTION 6 - WEIGHT AND BALANCE**

Factory installed optional equipment is included in the licensed weight and balance data in Section 6 of the Pilot's Operating Handbook and Airplane Flight Manual.

## SECTION 7 - DESCRIPTION AND OPERATION

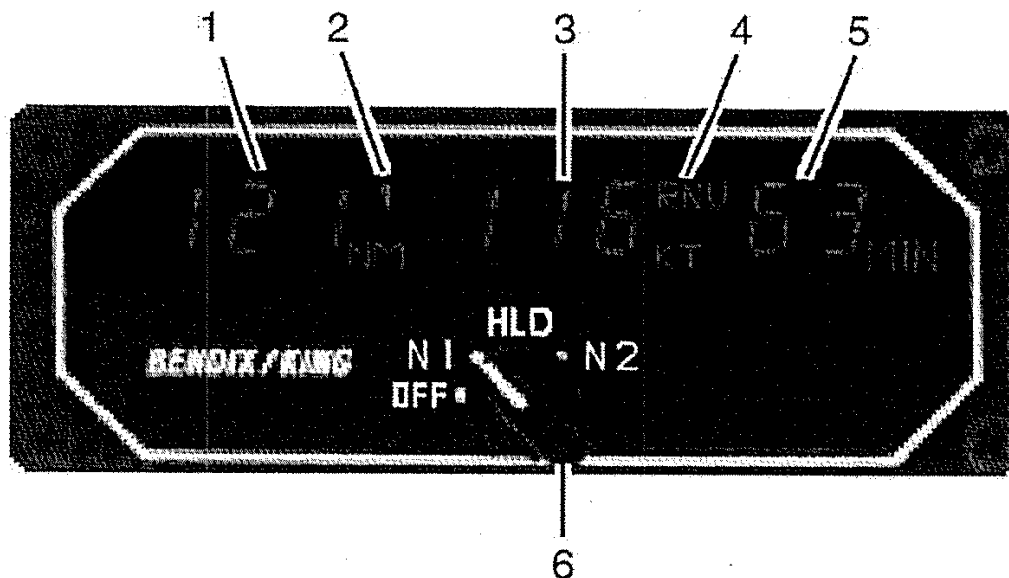

Bendix/King KN-63 DME

Figure 1

## Legend - Figure 1

1. DISTANCE DISPLAY (NM) - DME distance to VORTAC/WAYPOINT displayed in .1 nautical mile increments up to 99.9 NM, then in increments of one nautical mile to 389 NM.
2. DME MODE ANNUNCIATOR - Displays the DME operating mode; NAV 1 (1); NAV 2 (2); NAV 1 HOLD (H1); NAV 2 HOLD (H2); of the mode selector switch (6).
3. GROUND SPEED DISPLAY (KT) - Displays ground speed in knots to or from VORTAC/WAYPOINT up to 999 knots (aircraft must be flying directly to or from the VORTAC/WAYPOINT for true ground speed indication).
4. RNAV ANNUNCIATOR (RNV) - Indicates RNV when displayed data is in relation to the RNAV waypoint. If the wrong DME mode is selected during RNAV operation, the RNAV annunciator will flash.
5. TIME-TO-STATION DISPLAY (MIN) - Displays time-to-station (VORTAC/WAYPOINT) in minutes up to 99 minutes (aircraft must be flying directly to or from the Vortac/Waypoint for true time-to-station indication).

**SECTION 7 - DESCRIPTION AND OPERATION (continued)**

**Legend - Figure 1 (continued)**

6. DME MODE SELECTOR SWITCH (OFF, N1, HLD, N2) - Applies power to the DME and selects DME operating mode as follows:

OFF: Turns DME power off.

NAV 1

(N1): Selects DME operation with No. 1 VHF navigation set; enables channel selection by NAV 1 frequency selector controls.

HOLD

(HLD): Selects DME memory circuit; DME remains channeled to station to which it was last channeled when HOLD was selected and will continue to display information relative to this channel. Allows both the NAV 1 and NAV 2 navigation receivers to be set to new operational frequencies without affecting the previously selected DME operation.

**NOTE**

In the HOLD mode there is no annunciation of the VOR/DME station frequency. However, an annunciator labeled "H1" or "H2" illuminates on the DME display to flag the pilot that the DME is in the HOLD mode.

NAV 2

(N2): Selects DME operation with No. 2 VHF navigation set; enables channel selection by NAV 2 frequency selector switches. Brightness of the labels for this switch is controlled by the RADIO light dimming rheostat.

**PILOT'S OPERATING HANDBOOK  
AND  
FAA APPROVED AIRPLANE FLIGHT MANUAL**

**SUPPLEMENT NO. 21  
FOR  
GARMIN GNS 430W VHF COMMUNICATION  
TRANSCEIVER/VOR/ILS RECEIVER/GPS RECEIVER**

This supplement must be attached to the Pilot's Operating Handbook and FAA Approved Airplane Flight Manual when the Garmin GNS 430W VHF Communication Transceiver/VOR/ILS Receiver/Global Positioning System is installed per the Equipment List. The information contained herein supplements or supersedes the Pilot's Operating Handbook and FAA Approved Airplane Flight Manual only in those areas listed herein. For limitations, procedures and performance information not contained in this supplement, consult the Pilot's Operating Handbook and FAA Approved Airplane Flight Manual.

FAA APPROVED:



Wayne E. Gaulzetti  
ODA-510620-CE  
Piper Aircraft, Inc.  
Vero Beach, Florida

DATE OF APPROVAL: MAY 12, 2010

**ISSUED: JULY 12, 1995**  
**REVISED: MAY 12, 2010**

**REPORT: VB-1612** |  
**Page 1 of 12 • 9-173** |

**SECTION 1 – GENERAL**

The GNS430W System is a fully integrated, panel mounted instrument, which contains a VHF Communications Transceiver, a VOR/ILS receiver, and a WAAS-enabled Global Positioning System (GPS) Navigation computer. The system consists of a GPS antenna, GPS/WAAS receiver, VHF VOR/LOC/GS antenna, VOR/ILS receiver, VHF COMM antenna and a VHF Communications transceiver. The primary function of the VHF Communication portion of the equipment is to facilitate communication with Air Traffic Control. The primary function of the VOR/ILS Receiver portion of the equipment is to receive and demodulate VOR, Localizer, and Glide Slope signals. The primary function of the GPS/WAAS portion of the system is to acquire signals from the GPS system satellites, recover orbital data, make range and Doppler measurements, and process this information in real-time to obtain the user's position, velocity, and time.

Provided the GARMIN GNS 430W's GPS/WAAS receiver is receiving adequate usable signals, it has been demonstrated capable of and has been shown to meet the accuracy specifications for:

- GPS/WAAS TSO-C146a Class 3 Operation: The Garmin GNS430W uses GPS and WAAS (within the coverage of a Space-Based Augmentation System complying with ICAO Annex 10) for enroute, terminal area, non-precision approach operations (including "GPS" and "RNAV" approaches) and approach procedures with vertical guidance (including "LNAV/VNAV" and "LPV").

GPS navigation is accomplished using the WGS-84 (NAD-83) coordinate reference datum. GPS navigation data is based upon use of only the Global Positioning System (GPS) operated by the United States of America.

**SECTION 1 - GENERAL (continued)****Class II Oceanic, Remote, and other operations**

The Garmin 430W has been found to comply with the requirements for GPS primary means of Class II navigation in oceanic and remote airspace when used in conjunction with Garmin Prediction Program part number 006-A0154-03. Oceanic operations are supported when the GNS430W unit annunciates OCN. This provides an alarm limit of four nautical miles and a mask angle of five degrees. The GNS430W unit also has the ability to predict RAIM availability at any waypoint in the database if WAAS corrections are expected to be absent or disabled. This does not constitute an operational approval for Oceanic or Remote area operations. Additional equipment installations or operational approvals may be required.

- Oceanic navigation requires an additional approved long range oceanic and/or remote area navigation system with independent display, sensors, antenna, and power source.
- Redundant VHF Com and VHF Nav systems may be required for other than US 14 CFR Part 91 operations. Check foreign regulation requirements as applicable.
- Operations approval may be granted for the use of the GNS430W unit RAIM prediction function in lieu of the Prediction Program for operators requiring this capability. Refer to your appropriate civil aviation authorities for these authorizations.

**SECTION 2 – LIMITATIONS**

**Pilot’s Guide**

The Garmin 400W Series Pilot’s Guide, part number and revision listed below (or later revisions), must be immediately available for the flight crew whenever navigation is predicated on the use of the GNS430W unit.

- 400W Series Pilot’s Guide & Reference P/N 190-00356-00 Rev. B, or later revision.

This AFM supplement does not grant approval for IFR operations to aircraft limited to VFR operations. Additional aircraft systems may be required for IFR operational approval.

**System Software**

The system must utilize the Main and GPS software versions listed below (or later FAA approved versions for this installation). The software versions are displayed on the self-test page immediately after turn-on, for approximately 5 seconds, or they can be accessed on the AUX-UTILITY page.

Subsequent software versions may support different functions. Check the 400W Series Pilot’s Guide for further information.

| <b>Approved Software Versions</b> |   |                             |
|-----------------------------------|---|-----------------------------|
| <b>Software Item</b>              | <b>Approved Software Version<br/>(or later FAA-approved versions)</b> |                             |
|                                   | <b>Software Version</b>   | <b>As Displayed on Unit</b> |
| Main Software Version             | 3.0   | 3.0                         |
| GPS Software Version              | 3.0   | 3.0                         |

**Table 1**

**Navigation Data Base**

The GNS430W unit database cards listed in the following table (or later FAA approved versions for this installation) must be installed.

- IFR enroute and terminal navigation is prohibited unless the pilot verifies the currency of the database or verifies each selected waypoint for accuracy by reference to current approved data.



**SECTION 2 - LIMITATIONS (continued)****Navigation Data Base (continued)**

- GPS instrument approaches using the GNS430W are prohibited, unless the GNS430W's approach data is verified by the pilot or crew to be current. Instrument approaches must be accomplished in accordance with an approved instrument approach procedure that is loaded from the GNS430W's database.
- Installations with dual 430W units will only crossfill between those units when they contain the same database cycle. Updating of each database must be accomplished on the ground prior to flight.

| <b>Approved Navigation Database Cards</b> |                                     |
|---|-------------------------------------|
| <b>Part Number</b>                        | <b>Description</b>                  |
| 010-10546-00                              | Data Card, WAAS, IFR, World Wide    |
| 010-10546-01                              | Data Card, WAAS, IFR, Americas      |
| 010-10546-02                              | Data Card, WAAS, IFR, International |

**Table 2**

**SECTION 2 - LIMITATIONS (continued)**

**Terrain Data Base**

The GNS430W supports Terrain and requires a Terrain database card to be installed in order for the feature to operate. The table below lists compatible database cards for the GNS430W. Each of the database cards contains the following data:

- The Terrain Database has an area of coverage from North 75° Latitude to South 60° Latitude in all longitudes.
- The Airport Terrain Database has an area of coverage that includes the United States, Canada, Mexico, Latin America, and South America.
- The Obstacle Database has an area of coverage that includes the United States, and is updated as frequently as every 56 days.

**NOTE**

The area of coverage may be modified as additional terrain data sources become available.

**Approved Terrain Database Cards**

| Part Number  | Description                      |
|--------------|----------------------------------|
| 010-10201-20 | Data Card, TAWS / Terrain, 128MB |
| 010-10201-21 | Data Card, TAWS / Terrain, 256MB |

**Table 3**

**Navigation**

No navigation is authorized north of 89° (degrees) north latitude or south of 89° (degrees) south latitude.

**SECTION 2 - LIMITATIONS (continued)****Approaches**

- During GPS approaches, the pilot must verify the GNS430W unit is operating in the approach mode. (LNAV, LNAV+V, L/VNAV, or LPV.)
- When conducting approaches referenced to true North, the heading selection on the AUX pages must be adjusted to TRUE.
- Accomplishment of an ILS, LOC, LOC-BC, LDA, SDF, MLS, VOR approach, or any other type of approach not approved for GPS overlay, is not authorized with GPS navigation guidance.
- Use of the GNS430W VOR/LOC/GS receiver to fly approaches not approved for GPS requires VOR/LOC/GS navigation data to be present on the external indicator (i.e. proper CDI source selection).

**Terrain Display**

Terrain refers to the display of terrain information. Pilots are NOT authorized to deviate from their current ATC clearance to comply with terrain/obstacle alerts. Terrain unit alerts are advisory only and are not equivalent to warnings provided by a Terrain Awareness and Warning System (TAWS). Navigation must not be predicated upon the use of the terrain display.

The terrain display is intended to serve as a situational awareness tool only. By itself, it may not provide either the accuracy or the fidelity on which to base decisions and plan maneuvers to avoid terrain or obstacles.

**VNAV**

VNAV information may be utilized for advisory information only. Use of VNAV information for instrument Approach Procedures does not guarantee Step-Down Fix altitude protection, or arrival at minimums in a normal position to land.

## SECTION 3 - EMERGENCY PROCEDURES

### Emergency Procedures

No change.

### Abnormal Procedures

- If the Garmin GNS430W GPS navigation information is not available, or is invalid, utilize other remaining operational navigation equipment installed in the airplane as appropriate. If the 430W loses GPS position and reverts to Dead Reckoning mode (indicated by the annunciation of “DR” in the lower left of the display), the moving map will continue to be displayed. Aircraft position will be based upon the last valid GPS position and estimated by Dead Reckoning methods. Changes in airspeed or winds aloft can affect the estimated position substantially. Dead Reckoning is only available in Enroute mode; Terminal and Approach modes do not support DR.
- If a “Loss of Integrity” (INTEG) message is displayed during:
  - Enroute/Terminal: continue to navigate using GPS equipment and periodically cross-check the GPS guidance to other approved means of navigation.
  - GPS Approach: GPS approaches are not authorized under INTEG - Execute missed approach or revert to alternate navigation.
- During a GPS LPV precision approach or GPS LNAV/VNAV approach, the 430W will downgrade the approach if the Horizontal or Vertical alarm limits are exceeded. This will cause the vertical guidance to flag as unavailable. The procedure may be continued using the LNAV only minimums.
- During any GPS approach in which precision and non-precision alarm limits are exceeded, the 430W will flag the lateral guidance and generate a system message “ABORT APPROACH loss of navigation”. Immediately upon acknowledging the message the unit will revert to Terminal alarm limits. If the position integrity is within these limits, lateral guidance will be restored and the GPS may be used to execute the missed approach, otherwise alternate means of navigation should be utilized.
- In an in-flight emergency, depressing and holding the Comm transfer button for 2 seconds will select the emergency frequency of 121.500 Mhz into the “Active” frequency window.

**SECTION 4 - NORMAL PROCEDURES**

Refer to the 400W Series unit Pilot's Guide defined in Section 2 - Limitations of this supplement for normal operating procedures. This includes all GPS operations, VHF COM and NAV, and Multi-Function Display (optional) information.

Although intuitive and user friendly, the GNS430W requires a reasonable degree of familiarity to prevent operations without becoming too engrossed at the expense of basic instrument flying in IMC and basic see-and-avoid in VMC. Pilot workload will be higher for pilots with limited familiarity in using the unit in an IFR environment, particularly without the autopilot engaged. Garmin provides excellent training tools with the Pilot's Guide and PC based simulator. Pilots should take full advantage of these training tools to enhance system familiarization. Use of an autopilot is strongly encouraged when using the GNS430W in IMC conditions.

**Approaches with Vertical Guidance**

The GNS430W supports three types of GPS approaches with vertical guidance: LPV approaches, LNAV/VNAV (annunciated as L/VNAV) approaches, and LNAV approaches with advisory vertical guidance (annunciated as LNAV+V). For LNAV approaches with advisory vertical guidance, the GNS430W will announce LNAV+V indicating vertical guidance is available. LNAV minimums will be controlling in this case.

**NOTE**

If flying an LPV or LNAV/VNAV approach, be prepared to fly the LNAV only approach prior to reaching the final approach fix (FAF). If the GPS integrity is not within vertical approach limits, the system will flag the vertical guidance. This may be announced by a downgrade to LNAV message.

For additional information on approaches with vertical guidance, refer to the 400W Series unit Pilot's Guide.

## SECTION 4 - NORMAL PROCEDURES (continued)

### Autopilot Operation

The Garmin GNS430W may be coupled to the STEC 55X Autopilot when operating as prescribed in the LIMITATIONS section of this supplement. For lateral guidance, the STEC 55X Autopilot may utilize GPSS or GPS Roll Steering in lieu of the analog deviation information. For autopilot operational instructions, refer to the FAA approved Flight Manual or Flight Manual Supplement for the autopilot.

### Coupling the Autopilot during Approaches

The Garmin GNS430W supports analog and digital (GPSS) control interfaces to the STEC 55X Autopilot. The STEC 55X may use digital GPS roll steering commands (GPSS) during GPS enroute, terminal, and LNAV approach operations only. When switching between GPS and VLOC, the pilot should be aware that the autopilot will need to be re-engaged in GPSS or NAV/APR, depending on the CDI nav source last selected or the type of approach desired.

Autopilot coupling to GPS vertical guidance requires that the autopilot be engaged in an analog APR mode identical to coupling to an ILS. To capture the vertical guidance, the pilot may engage the autopilot in APR mode at any time when the GPS Glide Slope (VDI) becomes valid (displayed without a FLAG).

Should a missed approach be required per the published missed approach procedure, the autopilot must be engaged in GPSS mode for proper guidance.

### CAUTION

Do not operate the autopilot in the approach (APR) mode when conducting the published missed approach procedure.

**SECTION 4 - NORMAL PROCEDURES (continued)****WFDE Prediction Program**

The Garmin WAAS Fault Detection and Exclusion (WFDE) Prediction Program is required for Remote/Oceanic operations.

The Prediction Program should be used in conjunction with the Garmin 400W/500W Simulator. After entering the intended route of flight in the Simulator flight plan, the pilot selects the FDE Prediction Program under the Options menu of the Simulator program.

For detailed information, refer to the WFDE Prediction Program instructions (190-00643-01). The availability of FDE is only required for Oceanic or Remote operations.

**SECTION 5 - PERFORMANCE**

No change.

**SECTION 6 - WEIGHT AND BALANCE**

No change.

**SECTION 7 - DESCRIPTION AND OPERATION**

See Garmin 400W Series unit Pilot's Guide for a complete description of the GNS430W unit.

**THIS PAGE INTENTIONALLY LEFT BLANK**



**PILOT'S OPERATING HANDBOOK  
AND  
FAA APPROVED AIRPLANE FLIGHT MANUAL**

**SUPPLEMENT NO. 22  
FOR  
GARMIN G500 PRIMARY FLIGHT AND  
MULTIFUNCTION DISPLAY SYSTEM**

The FAA approved operational supplement for the Garmin G500 PFD/MFD System, installed in accordance with STC SA02015SE-D, is required for operation of this system. Garmin will be responsible to supply and revise the operational supplement. It is permitted to include the Garmin G500 PFD/MFD supplement in this location of the Pilot's Operating Handbook unless otherwise stated by Garmin. The information contained in the Garmin G500 PFD/MFD supplement may supersede or supplement the information in the basic Pilot's Operating Handbook and FAA Approved Airplane Flight Manual with respect to the operation of the Garmin G500 PFD/MFD System. For limitations, procedures and performance information not contained in the Garmin supplement, consult the basic Pilot's Operating Handbook and FAA Approved Airplane Flight Manual.

THIS PAGE INTENTIONALLY LEFT BLANK

## **Airplane Flight Manual Supplement**

**g – No.E-362-E**

for the

**3-Blade Constant Speed Propeller System  
MTV-12-B/180-17**

installed on the Airplane (all Serial Numbers)

**PIPER PA 28R-180  
with 200 HP-Engine**

**PIPER PA 28R-200**

**PIPER PA 28R-201**

**PIPER PA 28RT-201**

available Mufflerconfigurations:

1. without muffler
2. Muffler Gomolzig PA28-606504
3. Muffler Liese W 60

Copyright of this document remains with MT-Propeller, D-94348 Atting, Germany. Illegal use will be prosecuted.

Edition, Jan. 16, 2004  
Revision 2 – April 21, 2006

Translation of the LBA approved Airplane Flight Manual Supplement No. E-362 Issued Sept.19,1996

Page 1 of 4  
 Airplane Flight Manual Supplement No. E-362 E  
 PA-28R-180 (200HP), PA28R-200/-201, PA28RT-201  
 Edition Jan. 16, 2004  
 Revision 2 – April 21, 2006

This Airplane Flight Manual Supplement belongs to the aircraft:

Aircraft registration No: HB-PQY

Serial No.: 284420

Year of manufacture: 2005

TCDS No. 518, 158a

This Airplane Flight Manual Supplement contains all supplemental information to operate the aircraft with the MTV-12-B/180-17 constant speed propeller.

The information contained in the Original POH/AFM remains valid further on, provided that there are no amendments in this Airplane Flight Manual Supplement.

**Caution:** Because of the RPM reduction to 2500 U/min, the information given in the Original POH/AFM concerning 2.700 RPM or 2.600 RPM are no longer valid on, except the take off performance.

| List of revisions        |   |   |  |
|--------------------------|---|---|--|
| Edition/<br>Revision No. | Page<br>Date                                    | Description   | Approved   |
| 1                        | Pages 1 to 4 and<br>cover page<br>Jan. 16, 2004 | Initial Issue   | LBA, 29. Jan. 04   |
| 2                        | Pages 3   | Editorial change. Spinner No.<br>E-328 changed to P-391 | Revision No. 2 to the AFMS No.<br>E-362-E is approved under the<br>authority of DOA No.<br>EASA.2TJ.020<br><br>Entwicklung GmbH<br>Flugplatzstr.<br>D-94048 Aiting<br>Tel. 0 94 29/8 40 90<br>Martin Albrecht<br>Head, Office of Airworthiness |

## 1. GENERAL

Information concerning the propeller MTV-12-B/180-17 see Section 2.

## 2. LIMITATIONS

### Propeller MTV-12-B/180-17:

Diameter: 180 cm (70,87 in)  
cut-off to 177 cm (69,69 in) allowed for repair

Blade angle: at station 63 cm (24,80 in) :  
low pitch: 13.0°  $\pm$ 0.2°  
high pitch: 30.0°  $\pm$ 1.0°

### Propeller Speed:

max. allowable take-off power (5 minutes): 2700 RPM  
max. allowable continuous power: 2500 RPM

### Placards:

Markings at the propeller speed indicator :

|                 |                               |
|-----------------|-------------------------------|
| green arc       | between 500 RPM and 2500 RPM  |
| yellow arc      | between 2500 RPM and 2700 RPM |
| red radial line | at 2700 RPM                   |

Markings and placards concerning other propellers, are obsolete.

Propeller-Governor: According to Piper equipment list

Propeller-Spinner: MT-Propeller No. P-391  
The aircraft may be operated without spinner as well.  
In this case remove filler plates.

## 3. EMERGENCY PROCEDURES

No changes

## 4. NORMAL PROCEDURES

Move the propeller lever gently, because the propeller MTV-12-B/180-17, which is equipped with light-weight wood-composite blades, reacts quicker to RPM-changes as the standard propeller with metal blades.

For climb and cruise max. continuous propeller speed of 2500 RPM is valid, when the propeller MTV-12-B/180-17 is installed.

**5. PERFORMANCE**

Max. continuous speed with MTV-12-B/180-17 propeller: 2500 RPM

Max take off speed ( 5 min) with MTV-12-B/180-17 propeller: 2700 RPM

The information given in the charts of the Original POH/AFM concerning take off performance (landing gear extended or retracted), time, distance and fuel consumption at take off are valid further when the MTV-12-B/180-17 propeller is installed, continuous propeller speed is 2500 RPM.

**Warning:** Because of the smaller propeller diameter of the MTV-12-B/180-17 propeller, the climb performance is reduced by about 2-3%. The charts are valid further on, the data change is insignificant because of the scale of the chart used in the Original POH/AFM.

The charts for cruise speed is replaced by the table below.

Other information given in the Original POH/AFM remain valid further on.

Noise:

With the MTV-12-B/180-17 propeller extended German noise requirements are fulfilled.

**6. WEIGHT AND BALANCE; LIST OF EQUIPMENT**Propeller-weight and propeller arm:

## Original equipment

Mc Cauley B2D34C213/90DHA-16 propeller with spinner  
or Mc Cauley 2D34C215/90DJA-14E

|            |   |                            |
|------------|---|----------------------------|
| weight     | = | 24,4 kg (53.8 lbs)         |
| arm        | = | -4,9 cm (-1.9 in)          |
| massmoment | = | -1,1956 kgm (-102.2 inlbs) |

Hartzell HC-C2YK-1()/()7666A-2 propeller with spinner

|            |   |                           |
|------------|---|---------------------------|
| weight     | = | 27,2 kg (59.96 lbs)       |
| arm        | = | -4,24 cm (-1.7 in)        |
| massmoment | = | -1,1533 kgm (101.9 inlbs) |

## Intended equipment:

MTV-12-B/180-17 propeller with spinner

|            |   |                           |
|------------|---|---------------------------|
| weight     | = | 21,0 kg (46.3 lbs)        |
| arm        | = | -5,0 cm (-1.97 in)        |
| massmoment | = | -1,0500 kgm (-91.2 inlbs) |

## The following data must be added:

MTV-12-B/180-17 propeller with spinner

|        |   |                    |
|--------|---|--------------------|
| weight | = | 21,0 kg (46.3 lbs) |
| arm    | = | -5,0 cm (-1.97 in) |

| Cruisespeed Piper PA28R-201, PA28RT-201<br>PA28R-200, PA-28R-180 (200HP), |         |        |  |                    |                     |  |               |                |                            |                    |                     |
|---|---------|--------|--|--------------------|---------------------|--|---------------|----------------|----------------------------|--------------------|---------------------|
| Conditions:   |         |        | EGT = Peak-50°F<br>(on the rich side)<br>max. take off weight<br>flaps retracted |                    |                     | Engine: Lyc. IO-360-C<br>(%-performance related to max. engine<br>power=200HP) |               |                | Propeller: MTV-12-B/180-17 |                    |                     |
|   |         |        | 20°C below ISA   |                    |                     | ISA  |               |                | 20°C above ISA             |                    |                     |
| ALT(ft)   | nP(RPM) | MAP["] | %PWR<br>Std-20°C   | C[lph]<br>Std-20°C | TAS[kt]<br>Std-20°C | %PWR<br>Std  | C[lph]<br>Std | TAS[kt]<br>Std | %PWR<br>Std+20°C           | C[lph]<br>Std+20°C | TAS[kt]<br>Std+20°C |
| 10000   | 2500    | 19.7   | 67   | 41.0               | 135                 | 64   | 39.4          | 131            | 62                         | 38.0               | 127                 |
|   |         | 19     | 64   | 39.5               | 129                 | 62   | 38.0          | 125            | 60                         | 36.6               | 122                 |
|   |         | 18     | 61   | 37.5               | 124                 | 59   | 36.0          | 121            | 57                         | 34.7               | 117                 |
|   |         | 17     | 58   | 36.2               | 120                 | 56   | 34.8          | 117            | 54                         | 33.6               | 114                 |
|   | 2300    | 19.7   | 60   | 37.7               | 124                 | 58   | 36.0          | 121            | 56                         | 34.6               | 118                 |
|   |         | 19     | 58   | 36.9               | 122                 | 56   | 35.3          | 118            | 54                         | 33.9               | 115                 |
| 8000  | 2500    | 18     | 55   | 34.0               | 115                 | 53   | 32.5          | 112            | 51                         | 31.2               | 109                 |
|   |         | 17     | 52   | 32.9               | 111                 | 50   | 31.5          | 108            | 48                         | 30.2               | 106                 |
|   |         | 21.3   | 72   | 43.7               | 137                 | 69   | 42.0          | 133            | 67                         | 40.5               | 129                 |
|   |         | 20     | 68   | 41.0               | 129                 | 65   | 39.5          | 125            | 63                         | 38.1               | 122                 |
|   | 2300    | 19     | 64   | 39.0               | 124                 | 62   | 37.5          | 121            | 60                         | 36.2               | 117                 |
|   |         | 18     | 61   | 37.7               | 120                 | 59   | 36.3          | 117            | 57                         | 35.0               | 114                 |
|   |         | 21.5   | 65   | 39.6               | 128                 | 63   | 38.2          | 125            | 61                         | 36.9               | 121                 |
|   |         | 20     | 61   | 38.0               | 120                 | 59   | 36.6          | 117            | 56                         | 35.4               | 114                 |
| 6000  | 2500    | 19     | 58   | 35.3               | 116                 | 56   | 34.0          | 113            | 54                         | 32.9               | 110                 |
|   |         | 18     | 55   | 34.1               | 113                 | 53   | 32.9          | 110            | 51                         | 31.9               | 107                 |
|   |         | 23     | 78   | 44.8               | 137                 | 75   | 43.3          | 134            | 72                         | 42.0               | 132                 |
|   |         | 22     | 74   | 43.1               | 135                 | 72   | 41.7          | 132            | 69                         | 40.4               | 129                 |
|   | 2300    | 21     | 71   | 41.4               | 130                 | 68   | 40.0          | 127            | 66                         | 38.8               | 125                 |
|   |         | 20     | 68   | 40.0               | 125                 | 65   | 38.7          | 123            | 63                         | 37.5               | 120                 |
|   |         | 23.2   | 70   | 42.6               | 132                 | 68   | 41.0          | 128            | 65                         | 39.5               | 125                 |
|   |         | 22     | 67   | 41.2               | 126                 | 64   | 39.7          | 123            | 62                         | 38.3               | 120                 |
| 4000  | 2500    | 21     | 64   | 38.5               | 122                 | 61   | 37.0          | 119            | 59                         | 35.7               | 116                 |
|   |         | 20     | 61   | 37.3               | 118                 | 59   | 35.9          | 115            | 56                         | 34.6               | 112                 |
|   |         | 25     | 84   | 47.8               | 137                 | 81   | 46.2          | 135            | 78                         | 44.8               | 132                 |
|   |         | 24     | 81   | 46.1               | 137                 | 78   | 44.6          | 134            | 75                         | 43.3               | 132                 |
|   | 2300    | 23     | 77   | 44.4               | 132                 | 75   | 43.0          | 129            | 72                         | 41.7               | 128                 |
|   |         | 22     | 74   | 43.0               | 127                 | 72   | 41.6          | 125            | 69                         | 40.4               | 123                 |
|   |         | 24     | 73   | 43.0               | 129                 | 70   | 41.6          | 126            | 68                         | 40.4               | 124                 |
|   |         | 23     | 70   | 41.7               | 126                 | 67   | 40.4          | 123            | 65                         | 39.2               | 121                 |
| 2000  | 2500    | 22     | 67   | 39.9               | 122                 | 64   | 38.6          | 119            | 62                         | 37.5               | 117                 |
|   |         | 21     | 64   | 38.7               | 118                 | 61   | 37.5          | 116            | 59                         | 36.4               | 113                 |
|   |         | 26.8   | 90   | 51.2               | 139                 | 87   | 50.0          | 137            | 84                         | 49.0               | 136                 |
|   |         | 24     | 81   | 47.9               | 137                 | 78   | 46.8          | 135            | 75                         | 45.9               | 134                 |
|   | 2300    | 23     | 77   | 46.7               | 132                 | 75   | 45.7          | 131            | 72                         | 44.8               | 129                 |
|   |         | 21     | 71   | 43.6               | 123                 | 68   | 42.7          | 122            | 66                         | 41.9               | 121                 |
|   |         | 24     | 73   | 48.6               | 125                 | 70   | 45.0          | 122            | 68                         | 41.8               | 118                 |
|   |         | 23     | 70   | 47.3               | 121                 | 67   | 43.8          | 117            | 65                         | 40.7               | 114                 |
| 2000  | 2300    | 22     | 67   | 40.3               | 117                 | 64   | 37.0          | 113            | 62                         | 34.0               | 110                 |
|   |         | 21     | 64   | 38.9               | 113                 | 61   | 35.8          | 110            | 59                         | 32.9               | 107                 |

## Anhang zum Flughandbuch mit Nachschalldämpfer-Anlage "System Gomolzig" PA28 - 606504

Dieser Anhang zum Flughandbuch gehört zum Flugzeug:

Baureihe: PA-28R-201 Kennzeichen: 401-HB-PQY  
Werk-Nr.: 2844120 Baujahr: 2005  
Kennblatt-Nr.: 518 /518a

Es enthält alle ergänzenden Informationen, die für den Betrieb des Flugzeuges mit der o. a. Schalldämpfer-Anlage erforderlich sind.  
Die Angaben des Originalflughandbuches behalten weiterhin ihre Gültigkeit, sofern in diesem Anhang nicht anders festgelegt.

- Section 1 ALLGEMEINES  
Dieses Flugzeug ist mit einer Nachschalldämpfer-Anlage System Gomolzig ausgestattet.
- Section 2 BETRIEBSGRENZEN  
Die im Flughandbuch angegebenen Daten sind unverändert gültig.
- Section 2.23 Lärmpegel:  
Mit der Nachschalldämpfer-Anlage "System Gomolzig" PA28 - 606500 werden die Lärmschutzforderungen für Luftfahrzeuge vom 1. Januar 1991 nach KapX erfüllt.
- Section 2.25 Hinweisschilder:  
Die im Flughandbuch angegebenen Informationen sind unverändert gültig.
- 
- Section 6 GEWICHT UND SCHWERPUNKT  
Die Seite "Schwerpunkt und Gewicht" der Umrüstanweisung ist zu beachten.
- Section 7 BESCHREIBUNG UND FUNKTION DES FLUGZEUGS UND SEINER SYSTEME  
Dieses Flugzeug ist mit einer Nachschalldämpfer-Anlage System Gomolzig ausgestattet.
- Section 8 FLUGZEUG HANDHABUNG, SERVICE UND WARTUNG  
Vorflugkontrolle:  
Nachschalldämpfer-Anlage auf Beschädigungen und festen Sitz prüfen  
Die Seite "Wartungsanweisung" der Umrüstanweisung ist zu beachten.

LBA anerkannt: 



03. JUNI 1993



**FOCA APPROVED**  
**AIRCRAFT FLIGHT MANUAL SUPPLEMENT**  
 for  
**FLARM COLLISION WARNING DEVICE**

Aircraft Registration: HB-PQY

Aircraft Make: Piper

Aircraft Model: PA 28R-201 Arrow

Aircraft Serial Number: 2844120

Approval Reference & Date: EASA 0010012809-001 / Oct 2006

This document must be carried in the aircraft at all the times. It describes the operating procedures for a fix installed FLARM Collision Warning System and its interfaces in accordance with the **FLARM Installation FOCA Policy 1.6 (42-00.02)** or later versions. For Aircraft, TMG and Rotorcraft, this AFMS will only be valid when the installation has been approved by the authority.

The information contained herein supplements or supersedes the basic Flight Manual only in those areas listed herein. For limitations, procedures and performance information not contained in this document, consult the basic Flight Manual.

Swiss Federal Office of Civil Aviation approved

Date : 20. März 2006

Signature : *N. Lauf*



TABLE OF CONTENTS

SECTION 1 – GENERAL ..... 3

SECTION 2 – OPERATING LIMITATIONS ..... 4

SECTION 3 – EMERGENCY PROCEDURES ..... 5



SECTION 4 – NORMAL OPERATING PROCEDURES ..... 6

SECTION 5 – PERFORMANCE ..... 8

SECTION 6 – WEIGHT AND BALANCE ..... 8

SECTION 7 – SYSTEM DESCRIPTION ..... 8

LOG OF REVISIONS

| REVISION | Page | Description      | Date       | FOCA Approval   |
|----------|------|------------------|------------|---|
| Original | All  | Original release | 15.03.2006 |   |
|          |      |                  |            |   |
|          |      |                  |            |   |
|          |      |                  |            |   |
|          |      |                  |            |   |
|          |      |                  |            |   |
|          |      |                  |            |   |
|          |      |                  |            |   |

Note:

Only the Section 2, 3 and 4 of this Aircraft Flight Manual Supplement (AFMS) have been approved by the authority.

## SECTION 1 – GENERAL

The gliding scene has been confronted since years to dramatic mid air collision accidents. With the extreme fine shape and relatively high cruise speed of modern gliders, the human vision has reached its limit of detection. Another aspect is the airspace restrictions to VFR that creates an augmentation of traffic density in certain areas and the associated airspace complexity that request more pilot attention on the navigation material. These have a direct impact on the probability of collision also affecting powered aircraft or rotorcraft operations.

These equipments in the general aviation are not required by technical specifications or by operation regulations, but are recognized by the regulators as an important step toward improved aviation safety. Therefore they are not considered as essential for flight and may be used for “situational awareness only” on basis of non interference to certified equipment necessary for safe flight/landing and no hazard to the persons on board.

Correct antenna installation has a great effect on the transmission/receiving range. The pilot shall care that no masking of the antenna occurs especially when the antennas (GPS + COM) are located in the cockpit.

FLARM will only give warnings of other aircraft that are likewise equipped with a compatible unit. FLARM does not communicate with Mode A/C/S transponders and is not detected by ACAS/TCAS/TPAS or Air Traffic Control. Likewise FLARM does not communicate with FIS-B, TIS-B or ADS-B systems.

The software version must be regularly updated as per the instructions given in the installation manual. If a version mismatch exists, error information is displayed during the equipment power ON and the system will not become operational.

A unique switch provides ready disconnection of all equipments connected to the Collision Avoidance function (FLARM, TR-DVS and other parts used with the installation) from the electrical bus in case of fume, fire, interferences or when flying over territories where the SRD frequency is not available for air-air communication. This switch is labeled adequately.

### Important Note:

**Operation of FLARM is forbidden in aircraft in which one or more of the occupants resides in or is a citizen of the USA or Canada. Likewise, use of FLARM is forbidden if the aircraft concerned takes off from, makes an intermediate or final landing in the USA or Canada**

## SECTION 2 - OPERATING LIMITATIONS

1. **This FLARM installation is compliant for “situation awareness only”.** The following placard must be installed on the instrumental panel, at the proximity of the display:

For Situation Awareness only

2. **Maneuvering must not be based solely on the use of the information presented on the FLARM displays or aural annunciations.** FLARM does not give any guidance on avoiding action. The azimuth and height accuracy of the computed traffic cannot always provide reliable warnings and only the most threatening traffic is announced. Therefore it is the pilot responsibility to evaluate by any means the real traffic position and altitude, the obstacle shape, the terrain and the meteorological situation prior executing any evasion maneuver.

**Under no circumstances should a pilot or crewmember adopt different tactics or deviate from the normal principles of safe airmanship.**

3. **It is the pilot's responsibility to verify prior entering any states territory that the SRD frequency is permitted for use in air-air communication.** When such an acceptance does not explicitly or implicitly exist, the equipment shall be turned OFF. This verification is part of the flight planning.
4. **The pilot shall not intentionally generate uncoordinated warnings that might frighten other aircraft's pilot.** Any intentional maneuver of this kind has to be carefully coordinated and agreed in advance. Unexpected reactions might be especially hazardous when lateral, vertical or time separations are small.

## SECTION 3 - EMERGENCY PROCEDURES

In case of **Fire, Smoke, electrical burning smells or Electromagnetic Interferences** follow the Emergency procedure of the basic AFM.

FLARM is normally installed on a non-essential bus. But on ancient aircraft it is possible that only an avionics bus or even only a main bus is available for all electrical consumers. The basic Emergency procedure might require this bus disconnection that will generate a total loss of Navigation, Communication and ATC detection. This is classified as a catastrophic failure condition under IMC condition.

**The dedicated FLARM switch will help to rapidly determine if the FLARM installation is faulty or not,** allowing to resume essential equipments as per the Emergency procedure of the basic Aircraft Flight Manual.

## SECTION 4 - NORMAL OPERATING PROCEDURES

### 4.1 General

It is recommended to carry the FLARM Operating Manual version 3 or later on board the aircraft. To make good use of the information contains in this manual the pilot should know the hardware version, the software version, the serial number and the obstacle database name currently installed in the FLARM.

### 4.2 Self-test

To switch on the FLARM, the aircraft electrical power shall be available on the corresponding bus and the dedicated FLARM switch must be turned ON.

After switching on, the unit performs a self-test routine, quickly lights up all LED and displays either error codes or version numbers. The Operating Manual describes how errors and version numbers are being shown. If an error is being shown, the unit is not ready for operations.

When FLARM shifts to normal operation it waits until it has acquired an adequate GPS position fix. When switching on the unit after a long break or in a totally new location, this procedure can take *several minutes*. Without a proper GPS position fix, the unit is not ready for operation.

Before departure the pilot must ensure that the LED status is "operational" (refer to the Operating Manual).

### 4.3 Operation Modes

FLARM operates in two modes, *Nearest* and *Collision*. When switched on, the unit is in *Nearest* mode. The warnings given are identical in both modes, and generally relate to an immediate threat to which the pilot should have an immediate and appropriate reaction.

When operating in the *Nearest* mode, the unit also reports the presence of other aircraft operating in the vicinity, even though calculations indicate that they do not represent a threat. As soon as FLARM detects the risk of a collision it automatically switches to *Collision* mode, followed by automatic reversion to *Nearest*.

In both modes the pilot can suppress the display and the acoustic warning: after a double push FLARM will suppress all visual and acoustic signals relating to traffic, obstacles or other threats. While warnings are suppressed, FLARM nevertheless continues to transmit signals for reception by other aircraft.

### 4.4 Airborne and Alerts

In case other compatible units are within range, also the Receive LED is ON. The horizontal and vertical indicators show the direction of the most imminent threat with a flashing red display. The first warning level for another aircraft is delivered when less than **18 seconds** remains to the possible collision; the second warning level is delivered when less than **13 seconds** remains; the third level when less than **8 seconds** remains.

When a number of moving threats or fixed objects are within range, then FLARM gives warning only of the most dangerous in accordance with the threat calculation algorithm. The pilot is unable to call for presentation of further threats. The warning indicates the earliest likely collision that could happen.

Depending upon the phase of the flight, FLARM uses different movement models, forecasting methods and warning calculations to provide the pilot with the best possible support without causing a distraction. For example, when a sailplane is circling, the system sensitivity is reduced. These models and processes have been optimised, but are nevertheless a compromise.

The thread might also be an obstacle (e.g. cables, antenna masts, cable cars, avalanche dynamite wires, power lines). In the case of fixed obstacles, the unit does not signal a bearing. Obstacle warnings are dependent on the information having been stored correctly in the internal data bank. The unit cannot give warning of any fixed object that has either been incorrectly stored or not stored at all.

Whether and how avoiding action is taken is solely a matter for the pilot, who must base his decision on his own observation of the airspace.

#### 4.5 Line of sight

Compatible FLARM units must be within range in order to provide a warning. The range is very much determined by the type, installation and position of the radio antennae, plus the relative positions of the two aircraft. Under optimum conditions the internal antennae can give a head-on range of up to 5 km; normally, range is about 2 km. The radio signals can only be received by line of sight. There is no FLARM signal between two aircraft on opposite sides of the same mountain.

#### 4.6 GPS signal quality

FLARM has to know its current position in order to operate. For this reason, FLARM will only operate in the presence of good quality three-dimensional GPS reception. GPS reception is greatly influenced by the installation and position of the antenna, and aircraft attitude. This is particularly true during turns, when flying close to mountain slopes and in areas known for poor reception. If the installation is poor the GPS signal quality may be reduced. In particular, there can be rapid degradation of height calculations. FLARM resumes operation as soon as the GPS reception quality is adequate.

#### 4.7 Pressurized cabin

FLARM use an internal pressure sensor to determine the pressure altitude. This is an important element to verify the GPS positioning quality and to ensure an accurate and smooth altitude processing. When installed in a pressurized aircraft the FLARM system will not operate correctly until it is properly connected to an external static port.

#### 4.8 Predicted flight path and accuracy

When close up, when two aircraft are at the same or similar height, or GPS reception is poor, the vertical bearing indication is imprecise and fluctuates.

FLARM calculates the predicted flight path of the aircraft to which it is fitted for less than the next 30 seconds. This prediction is based on immediate past data, current position- and movement data, plus a movement prediction model that is optimised for the respective user. This forecast is associated with a number of uncertainties that increase with an extension of the forecast time. There is no guarantee that an aircraft will actually follow the predicted flight path. For this reason, the warning issued will not be accurate in all cases.

#### 4.9 Effect of wind

Movements calculated by the GPS relate to a fixed system of terrestrial coordinates. In strong wind there may be a substantial difference between aircraft heading and track, leading to a distortion of the threat bearing. If the wind speed is one third of True Airspeed (TAS) and the yaw-free aircraft Heading is 90° out of wind, then the threat indication displayed has an error of about 18°. If the wind is very strong, the Track can deviate up to 180° from Heading. Under such circumstances and when circling, the warnings given are unusable.

#### 4.10 Data protection

The transmitter has no effect on what the receiver in the other aircraft does with the data. It is possible that this data may be captured and stored by other aircraft, or by ground stations, or used for other purposes. This opens up a range of possibilities, some of which may be in the pilot's own interest, (e.g. automated generation of an sailplane launch logging system, aircraft tracking, last position recovery), while others may not be (e.g. detecting tailing of other aircraft, airspace infringements, failure to take avoiding action prior to a collision). When FLARM makes a transmission, the signal also bears identification. The user can -- even though this is not recommended -- configure the unit so that identification is generated randomly and alters at one-minute intervals, making a back-trace difficult.

## SECTION 5 – PERFORMANCE

No Change to basic flight manual

## SECTION 6 – WEIGHT AND BALANCE

No Change to basic flight manual

## SECTION 7 – SYSTEM DESCRIPTION

### 7.1 System description

FLARM receives position and movement information from an internal GPS receiver with an external GPS antenna. An optional pressure sensor further enhances the accuracy of position measurements. The predicted flight path is calculated by FLARM and the information transmitted by radio. Provided they are within receiving range, the signals are received by further aircraft also equipped with FLARM or compatible devices. The incoming signal is compared with the flight path predicted by calculation for the second aircraft. At the same time, FLARM compares the predicted flight path with known data on obstacles stored in an internal database.

The GPS and collision information received from other aircraft can also be made available for third party equipment (e.g. external display, speech synthesizer, PDA) via a serial data output.

Obstacle information stored has been simplified; for example, FLARM assumes that a power wire is slung absolutely straight between two fixed points with no sag. Likewise, data for power lines does not include all intermediate masts.

### 7.2 Hardware scheme

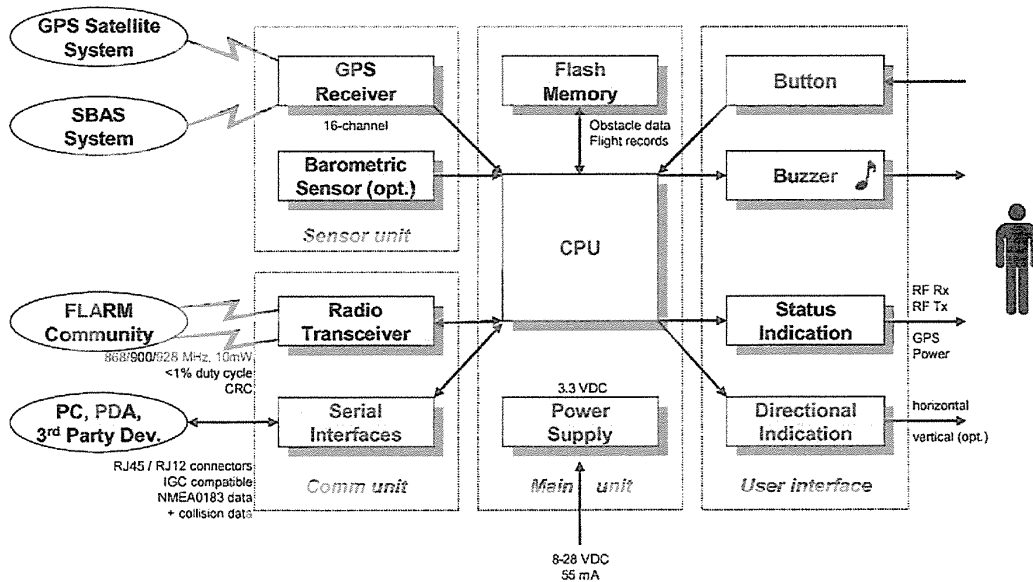



### 7.3 In-flight software scheme

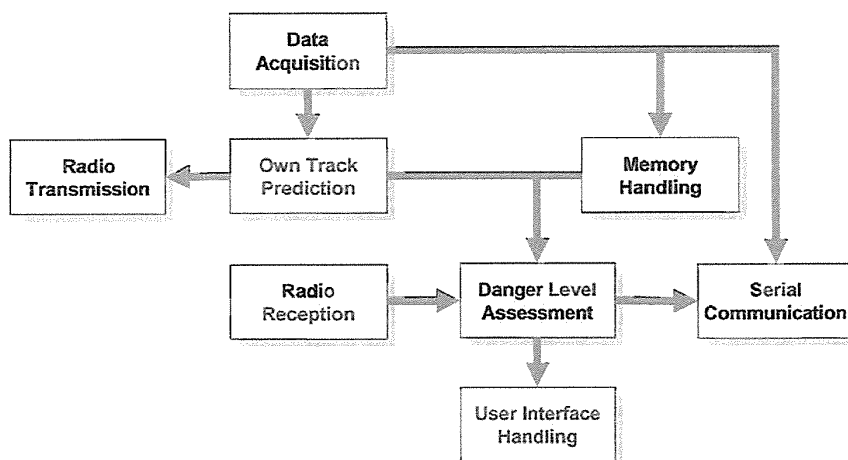

### 7.4 Radio transmission

The FLARM system uses a data communication frequency in the free Non-Specific Short Range Device (SRD), sub band f, between 868.0 – 868.6 MHz and with an ERP power of less than 10 mW (duty cycle 1%). This band is ruled for European applications in the documents ERC/REC 70-03 annex 1(f) and ERC/DEC/(01)04. The band is free for any ground-ground applications and gets no official protection against external interferences. ITU's recommendation for this band in region 1 is "mobile except aeronautical mobile". **FLARM is not considered as aeronautical mobile radio.**

There are national differences in frequency allocation and operating conditions between countries. To be used for air-air application some countries require an authorization to be granted by each national communication authority. In Switzerland, BAKOM/OFCOM has granted this authorization for the FLARM application on the 23 March 2004. On the 29 May 2005 FOCA confirmed to BAKOM/OFCOM that no Radio License will be required for FLARM. The aircraft commander is solely responsible for ensuring that their use of FLARM conforms to local regulations.

The radio transmission protocol employed places no limit on the number of units that may be operated within a given range. However, an increasing number of units within range is associated with a reduction in the probability that a single coded signal will be received ('graceful degradation'). The probability is small that subsequent signals will not be received from the same transmitter. FLARM is designed to receive and process signals from up to 50 aircraft within range. A high number of FLARM units within range has no effect on range.

### 7.5 Electrical installation

FLARM is requested to be installed on a non-essential bus. This is not always possible as certain older aircraft got only one avionics bus that is essential when flying under IFR rules. The FLARM installation is protected with a C/B. A dedicated power switch is provided with this installation to readily disconnect the FLARM installation when required by Emergency or operational needs. The pilot must be confident with his electrical bus topology and the FLARM installation.

**TABLE OF CONTENTS  
SECTION 10  
OPERATING TIPS**

| Paragraph<br>No. |                      | Page<br>No. |
|------------------|----------------------|-------------|
| 10.1             | General .....        | 10-1        |
| 10.3             | Operating Tips ..... | 10-1        |

**THIS PAGE INTENTIONALLY LEFT BLANK**

## SECTION 10

### OPERATING TIPS

#### 10.1 GENERAL

This section provides operating tips of particular value in the operation of the Arrow.

#### 10.3 OPERATING TIPS

- (a) Learn to trim for takeoff so that only a very light back pressure on the control wheel is required to lift the airplane off the ground.
- (b) The best speed for takeoff is about 70 KIAS under normal conditions. Trying to pull the airplane off the ground at too low an airspeed decreases the controllability of the airplane in the event of engine failure.
- (c) Flaps may be lowered at airspeeds up to 103 KIAS. To reduce flap operating loads, it is desirable to have the airplane at a slower speed before extending the flaps. The flap step will not support weight if the flaps are in any extended position. The flaps must be placed in the UP position before they will lock and support weight on the step.
- (d) Before attempting to reset any circuit breaker, allow a two to five minute cooling off period.
- (e) Before starting the engine, check that all radio switches, light switches and the pitot heat switch are in the off position so as not to create an overloaded condition when the starter is engaged.
- (f) Strobe lights should not be operating when flying through overcast and clouds, since reflected light can produce spatial disorientation. Do not operate strobe lights when in close proximity to ground, such as during taxiing, takeoff, or landing.

**10.3 OPERATING TIPS (continued)**

- (g) The rudder pedals are suspended from a torque tube which extends across the fuselage. The pilot should become familiar with the proper positioning of his feet on the rudder pedals so as to avoid interference with the torque tube when moving the rudder pedals or operating the toe brakes.
- (h) In an effort to avoid accidents, pilots should obtain and study the safety related information made available in FAA publications such as regulations, advisory circulars, Aviation News, AIM and safety aids.
- (i) Prolonged slips or skids which result in excess of 2000 ft. of altitude loss, or other radical or extreme maneuvers which could cause uncovering of the fuel outlet must be avoided as fuel flow interruption may occur when tank being used is not full.